



F





ОБЩИЕ СВЕДЕНИЯ

Раздел	Описание	Страница
1	Символы физических величин и единицы измерения	2
2	Крутящий момент	4
3	Мощность	4
4	Предельная термическая мощность	4
5	Коэффициент полезного действия	5
6	Передаточное число	5
7	Скорость вращения	6
8	Момент инерции	6
9	Эксплуатационный коэффициент	6
10	Обслуживание редукторов	7
11	Выбор изделия	8
12	Проверка правильности выбора	10
13	Установка редуктора	11
14	Хранение редуктора	11
15	Состояние изделий при поставке	11
16	Спецификации лакокрасочного покрытия	11

РЕДУКТОРЫ СЕРИИ F

17	Конструктивные особенности	12
18	Варианты исполнения	13
19	Идентификационная маркировка	14
20	Смазка	17
21	Рабочее положение редуктора и расположение клеммной коробки	18
22	Радиальная нагрузка	25
23	Осевая нагрузка	27
24	Антиреверсное устройство	27
25	Инструкции по установке переходных втулок - QF	29
26	Опции и специальные исполнения	30
27	Таблицы технических характеристик редукторов	32
28	Таблицы технических характеристик мотор-редукторов	64
29	Возможности комбинаций электродвигателей с редукторами	83
30	Момент инерции	86
31	Точные значения передаточных чисел	96
32	Размеры	97
33	Дополнительное оборудование	135
34	Вал приводимого механизма	138

ЭЛЕКТРОДВИГАТЕЛИ

M1	Символы физических величин и единицы измерения	140
M2	Общая характеристика	141
M3	Механические характеристики	143
M4	Электрические характеристики	147
M5	Асинхронные электродвигатели с тормозом	153
M6	Электродвигатели с тормозом постоянного тока типа BN_FD	154
M7	Электродвигатели с тормозом переменного тока типа BN_FA	158
M8	Электродвигатели с тормозом переменного тока типа BN_BA	161
M9	Системы разблокировки тормоза	164
M10	Опции	166
M11	Таблицы технических характеристик электродвигателей	171
M12	Размеры электродвигателей	187

Изменения и дополнения

Указатель изменений и дополнений см. на с. 200 настоящего каталога.

Ознакомиться с последними версиями каталогов можно на сайте компании: www.bonfiglioli.com



1 – СИМВОЛЫ ФИЗИЧЕСКИХ ВЕЛИЧИН И ЕДИНИЦЫ ИЗМЕРЕНИЯ

Символ	Единица измерения	Наименование
$A_{N 1, 2}$	[Н]	Допустимая осевая нагрузка
f_s	-	Эксплуатационный коэффициент
f_T	-	Термический коэффициент
f_{TP}	-	Температурный коэффициент
i	-	Передаточное число
I	-	Продолжительность включения (относительная)
J_c	[Кг м ²]	Момент инерции нагрузки
J_M	[Кг м ²]	Момент инерции двигателя
J_R	[Кг м ²]	Момент инерции редуктора
K	-	Коэффициент ускорения массы
K_r	-	Коэффициент радиальной нагрузки
$M_{1, 2}$	[Нм]	Крутящий момент
$M_{c 1, 2}$	[Нм]	Расчетный крутящий момент
$M_{n 1, 2}$	[Нм]	Номинальный крутящий момент
$M_r 1, 2$	[Нм]	Требуемый крутящий момент
$N_{1, 2}$	[мин ⁻¹]	Скорость вращения
$P_{1, 2}$	[кВ]	Мощность
$P_n 1, 2$	[кВ]	Номинальная мощность
$P_R 1, 2$	[кВ]	Потребляемая мощность
$R_{c 1, 2}$	[Н]	Расчетная радиальная нагрузка
$R_n 1, 2$	[Н]	Номинальная радиальная нагрузка
S	-	Коэффициент безопасности
t_a	[°С]	Температура окружающей среды
t_f	[мин]	Время работы при постоянной нагрузке
t_r	[мин]	Время покоя
η_d	-	Динамический КПД
η_s	-	Статический КПД

1 Значение для входного вала

2 Значение для выходного вала



Данным символом обозначаются углы направления радиальной нагрузки (вид с торца вала).



Символ указывает вес редукторов и мотор-редукторов. Значение, указанное в таблице для мотор-редукторов, включает в себя вес 4-х полюсного двигателя и масла (если редуктор поставляется заполненным маслом).

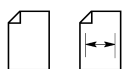

Символы обозначают страницы, на которых приведена информация.

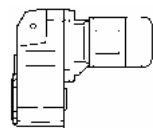

Мотор-редуктор с компактным электродвигателем.

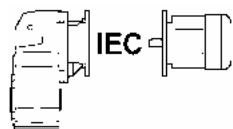

Мотор-редуктор с электродвигателем IEC



Редуктор с переходником под электродвигатель IEC



Редуктор с входным адаптером для сервомотора

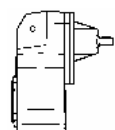

Редуктор с цельным входным валом



ОБЩАЯ ИНФОРМАЦИЯ

2 – КРУТЯЩИЙ МОМЕНТ

Номинальный выходной крутящий момент M_{n2} [Нм]

Крутящий момент, передаваемый на выходной вал при равномерной нагрузке. Номинальный крутящий момент рассчитывается для эксплуатационного коэффициента $f_s = 1$ и зависит от скорости вращения.

Требуемый крутящий момент M_{r2} [Нм]

Крутящий момент, необходимый исходя из требований приводимого механизма. Данная величина должна быть меньше или равна номинальному выходному крутящему моменту M_{n2} выбранного редуктора.

Расчетный крутящий момент M_{c2} [Нм]

Значение крутящего момента, которым необходимо руководствоваться при выборе редуктора с учетом требуемого крутящего момента M_{r2} (при требуемой скорости n_2) и эксплуатационного коэффициента f_s , вычисляется по формуле:

$$M_{c2} = M_{r2} \cdot f_s < M_{n2} \quad (1)$$

3 – МОЩНОСТЬ

Номинальная входная мощность P_{n1} [кВт]

Значение данной величины, приведенное в таблицах выбора редукторов, соответствует допустимой входной мощности, передаваемой на входной вал редуктора при скорости n_1 и эксплуатационном коэффициенте $f_s = 1$.

4 – ПРЕДЕЛЬНАЯ ТЕРМИЧЕСКАЯ МОЩНОСТЬ P_t [кВт]

Данная величина равна предельному значению передаваемой редуктором механической мощности в условиях непрерывной работы при температуре окружающей среды 20°C без повреждения узлов и деталей редуктора и ухудшения характеристик смазывающих материалов (см. таблицу A1). При температуре окружающей среды, отличной от 20°C , и прерывистом режиме работы значение P_t корректируется с учетом тепловых коэффициентов f_t , приведенных в таблице (A2), по следующей формуле: $P_t' = P_t \cdot f_t$

Для редукторов, имеющих более 2 ступеней редукции и/или передаточное число более $i = 45$, проверки предельной термической мощности обычно не требуется, поскольку в этом случае предельная термическая мощность обычно больше номинальной механической мощности.

(A1)

	P_t [кВт] 20°C	
	$n_1 = 1400 \text{ мин}^{-1}$	$n_1 = 2800 \text{ мин}^{-1}$
F 10 2	3.8	2.7
F 20 2	9.1	6.5
F 25 2	10.2	7.4
F 31 2	11.7	8.5
F 41 2	14.3	10.4
F 51 2	21.5	15.0
F 60 3	26.0	18.9
F 70 3	36.4	26.0
F 80 3	52	36
F 90 3	75	53



(A2)

		f_t			
t_a [°C]	Непрерывная работа	Прерывистый режим работы			
		Относительная продолжительность включения [I]			
		80%	60%	40%	20%
40	0.80	1.1	1.3	1.5	1.6
30	0.85	1.3	1.5	1.6	1.8
20	1.0	1.5	1.6	1.8	2.0
10	1.15	1.6	1.8	2.0	2.3

Относительная продолжительность включения (I)% равна процентному отношению времени работы под нагрузкой t_f к сумме времени работы под нагрузкой и времени покоя:

$$I = \frac{t_f}{t_f + t_r} \cdot 100 \quad (2)$$

Проверке подлежит выполнение следующего условия:

$$P_{r1} \leq P_t \times f_t \quad (3)$$



5 – КОЭФФИЦИЕНТ ПОЛЕЗНОГО ДЕЙСТВИЯ (КПД)

Динамический КПД [η_d]

Динамический КПД представляет собой отношение мощности, получаемой на выходном валу P_2 , к мощности, приложенной к входному валу P_1 .

$$\eta_d = \frac{P_2}{P_1} \cdot 100 \quad [\%] \quad (4)$$

(A3)

	2 x 	3 x 	4 x 
η_d	95%	93%	90%

6 – ПЕРЕДАТОЧНОЕ ЧИСЛО

Характеристика, присущая каждому редуктору, обозначаемая [i] и равная отношению скорости вращения на входе n_1 к скорости вращения на выходе n_2 :

$$i = \frac{n_1}{n_2} \quad (5)$$

Значения передаточных чисел в настоящем каталоге округлены до одного знака после запятой (а в случае $i > 1000$ – до целого числа). Точное значение передаточного числа можно получить в Отделе технической поддержки компании Bonfiglioli.



7 – СКОРОСТЬ ВРАЩЕНИЯ

Скорость на входе n_1 [мин⁻¹]

Входная скорость зависит от выбранного типа приводящего устройства. Значение, данное в каталоге, относится к случаю применения стандартных промышленных односкоростных и двухскоростных электродвигателей. В целях обеспечения оптимальных условий работы редуктора входная скорость по возможности не должна превышать 1400 об/мин. Превышение указанной величины допустимо, однако необходимо учитывать, что это оказывает негативное влияние на величину номинального выходного крутящего момента M_{n2} . В случае необходимости значительного превышения рекомендуемой входной скорости следует обратиться за консультацией в Службу технической поддержки компании Bonfiglioli.

Скорость на выходе n_2 [мин⁻¹]

Выходная скорость n_2 зависит от входной скорости n_1 и передаточного числа i ; вычисляется по формуле:

$$n_2 = \frac{n_1}{i} \quad (6)$$

8 – МОМЕНТ ИНЕРЦИИ J_r [кгм²]

Величина момента инерции, указанная в каталоге, относится к входному валу редуктора. Таким образом, в случае соединения редуктора непосредственно с двигателем это значение относится к скорости вращения вала двигателя.

9 – ЭКСПЛУАТАЦИОННЫЙ КОЭФФИЦИЕНТ f_s

Эксплуатационный коэффициент является количественным показателем тяжести предполагаемых условий эксплуатации редуктора с приблизительным учетом ежедневного цикла работы, изменений нагрузки и возможных перегрузок, связанных с особенностями конкретных условий эксплуатации изделия. Приведенный ниже график (A4) позволяет найти значение эксплуатационного коэффициента. Для этого, выбрав в столбце “h/d” (количество часов работы в сутки) нужное значение, следует на одной из кривых (K1, K2 или K3) найти значение искомого коэффициента в зависимости от числа включений в час. Выбор кривой K_ осуществляется в зависимости от типа условий эксплуатации (K1, K2 и K3 приблизительно соответствуют обычной равномерной нагрузке, условиям средней тяжести и тяжелым условиям эксплуатации) путем применения коэффициента ускорения нагрузки K, который зависит от отношения инерции приводимой нагрузки и собственной инерции двигателя. Независимо от полученного таким образом значения эксплуатационного коэффициента необходимо учитывать, что в некоторых устройствах, в частности в подъемных механизмах, поломка шестерни редуктора может вызвать опасность причинения травм находящимся по близости людям.

Консультацию относительно потенциальной опасности механизма для здоровья людей можно получить в службе технической поддержки компании BONFIGLIOLI RIDUTTORI.

(A4)

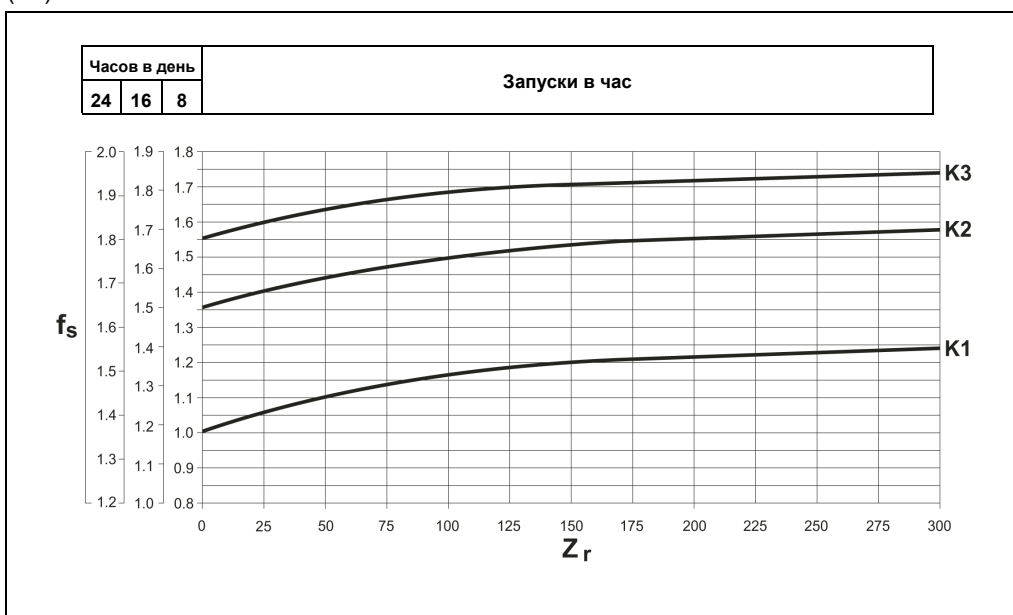



Коэффициент ускорения нагрузки, K

Данный параметр служит основанием для выбора одной из кривых типа нагрузки. Его значение вычисляется по формуле:

$K = \frac{J_c}{J_m}$	→	$J_c =$	момент инерции нагрузки на валу двигателя
		$J_m =$	момент инерции двигателя
$K \leq 0,25$	→	K1	равномерная нагрузка
$0,25 < K \leq 3$	→	K2	умеренные ударные нагрузки
$3 < K \leq 10$	→	K3	тяжелые ударные нагрузки
$K > 10$	→		Обратитесь за консультацией в службу технической поддержки Bonfiglioli

10 – ОБСЛУЖИВАНИЕ РЕДУКТОРОВ

Редукторы, заполняемые на заводе смазкой на весь период эксплуатации, в обслуживании не нуждаются. В других типах редукторов первая замена масла с промывкой специальным промывочным средством производится через 300 часов работы. Не допускается смешивание минеральных масел с синтетическими. Необходима регулярная проверка уровня масла и его замена через интервалы, указанные в таблице (A5) ниже.

(A5)

Температура масла [°C]	Периодичность замены [h]	
	Минеральное масло	Синтетическое масло
<65	8000	25000
65 - 80	4000	15000
80 - 95	2000	12500





11 – ВЫБОР ИЗДЕЛИЯ

Для оказания клиенту помощи в выборе редуктора Службе технической поддержки необходим ряд ключевых данных. Параметры, по которым необходима информация, указаны в таблице (А6) ниже.

Для упрощения процесса выбора заполните таблицу и вышлите копию в Службу технической поддержки, которая, исходя из полученных данных, произведет выбор привода, соответствующего требованиям устройства клиента.

(А6)

Тип устройства			
P_{r2}	Макс выходная мощность при n_2кВ	Направл. вращения вх/ вала (CW-CCW) (**)
P_{r2}'	Мин выходная мощность при n_2кВ	A_{c2} Осевая нагрузка на вых вал (+/-)(***)
M_{r2}	Макс выходной крутящий момент при n_2Нм	A_{c1} Осевая нагрузка на вх вал (+/-)(***)
n_2	Макс выходная скоростьмин ⁻¹	J_c Момент инерции нагрузки
n_2'	Мин выходная скоростьмин ⁻¹	t_a Темп. окружающей среды
n_1	Макс входная скоростьмин ⁻¹	Высота над уровнем моря
n_1'	Мин входная скоростьмин ⁻¹	Тип нагрузки по нормам IEC
R_{c2}	Радиальная нагрузка на выходной валН	Z Частота включений/ч
x_2	Расстояние до точки приложения нагрузки(*)мм	Напряжение питания двигателя.
	Радиальная нагрузка на выходной вал		Напряжение питания тормоза
	Направл. вращения вых/ вала (CW-CCW) (**)	Частота
	Радиальная нагрузка на входной валН	M_b Кр/момент тормоза
x_1	Расстояние до точки приложения нагрузки(*)мм	Степень защиты двигателя
	Радиальная нагрузка на выходной вал		Класс изоляции

(*) Расстояния x_1 и x_2 измеряются между точкой приложения нагрузки и местом выхода хвостовика вала (если данное расстояние не указано, при выборе будет учитываться нагрузка, приложенная к середине хвостовика вала).

(**) CW = по часовой стрелке; CCW = против часовой стрелки

(***) + = сжатие;

- = растяжение

Процедура выбора мотор-редукторов

а) Определите эксплуатационный коэффициент f_s , соответствующий типу нагрузки (в зависимости от коэффициента К), количеству включений в час Z_r и количеству часов работы в сутки.

б) Вычислите необходимую входную мощность по формуле:

$$P_{r1} = \frac{M_{r2} \cdot n_2}{9550 \cdot \eta_d} \quad [\text{kW}] \quad (7)$$

Значение η_d червячной передаче выводится из пар 5.



с) В таблицах выбора найдите таблицу, соответствующую требуемой номинальной мощности:

$$P_n \geq P_{r1} \quad (8)$$

При отсутствии иных указаний мощность двигателей P_n , указанная в каталоге, относится к режиму постоянной работы S1. Для двигателей, применяемых в условиях режимов, отличных от режима S1, необходимо указание требуемого режима в соответствии со стандартом CEI 2-3/IEC 34-1.

В частности, при работе в режимах S2 - S8 для двигателей типоразмера 132 и меньших, возможно получение дополнительной мощности по сравнению с мощностью в режиме постоянной работы; следовательно, должно быть выполнено следующее условие:

$$P_n \geq \frac{P_{r1}}{f_m} \quad (9)$$

Значения поправочного коэффициента f_m указаны в таблице (A7) ниже.

Относительная продолжительность включения

$$I = \frac{t_f}{t_f + t_r} \cdot 100 \quad (10)$$

t_f = время работы при постоянной нагрузке

t_r = время покоя

(A7)

	Режим работы						Обратиться за консультацией в Службу технической поддержки	
	S2			S3*				S4 – S8
	Продолжительность цикла (мин)			Относительная продолжительность включения (I)				
	10	30	60	25%	40%	60%		
f_m	1.35	1.15	1.05	1.25	1.15	1.1		

* Продолжительность цикла в любом случае не должна превышать 10 минут. При большей продолжительности цикла необходимо обратиться за консультацией в Службу технической поддержки Bonfiglioli.

Затем в соответствии с требуемой скоростью вращения на выходе n_2 выберите мотор-редуктор, коэффициент безопасности которого S больше или равен эксплуатационному коэффициенту f_s : $S \geq f_s$

Коэффициент безопасности определяется следующим образом:

$$S = \frac{Mn_2}{M_2} = \frac{Pn_1}{P_1} \quad (11)$$

В таблицах выбора мотор-редукторов представлены сочетания с двух-, четырех- и шестиполюсными двигателями, рассчитанными на частоту тока в сети 50Гц (соответственно 2800, 1400 и 900 об/мин). В случае необходимости применения электродвигателей с иными скоростями, производите выбор, ориентируясь на технические характеристики редукторов без электродвигателей.

Процедура выбора редукторов с переходником для электродвигателя или с цельным входным валом

а) Определите эксплуатационный коэффициент f_s , соответствующий типу нагрузки.

б) Вычислите требуемый выходной крутящий момент M_{c2} по следующей формуле:

$$M_{c2} = M_{r2} \cdot f_s \quad (12)$$



с) Определите требуемое передаточное число исходя из имеющихся данных о скорости на выходе n_2 и входной скорости n_1 :

$$i = \frac{n_1}{n_2} \quad (13)$$

Получив значения M_{c2} и i , исходя из скорости n_1 , выберите по таблице редуктор с передаточным числом i ближайшим к требуемому таким образом, чтобы номинальный крутящий момент M_{n2} был больше или равен расчетному крутящему моменту M_{c2} :

$$M_{n2} \geq M_{c2} \quad (14)$$

При необходимости сочленения выбранного редуктора с электродвигателем, проверьте возможность выбранного сочетания по таблице раздела 28 «Возможности комбинаций редукторов с электродвигателями».

12 – ПРОВЕРКА ПРАВИЛЬНОСТИ ВЫБОРА

После того, как выбор механизма привода сделан, рекомендуется проверить следующее:

а) Предельная термическая мощность

Убедитесь в том, что предельная термическая мощность редуктора больше или равна расчетной мощности, необходимой для данного устройства - см. формулу (3) на с.5. Если данное условие не выполняется, выберите редуктор большего размера или используйте систему принудительного охлаждения.

б) Максимальный крутящий момент

Максимально допустимый крутящий момент (при мгновенной пиковой нагрузке), приложенный к редуктору, в принципе не должен превышать 200% от номинального момента M_{n2} . Убедитесь в выполнении данного условия; при необходимости используйте соответствующие устройства ограничения крутящего момента.

В случаях применения трехфазных многоскоростных электродвигателей рекомендуется принимать во внимание величину крутящего момента при переключении с высокой скорости на более низкую, поскольку указанная величина может значительно превышать максимально допустимый крутящий момент.

Наиболее простым и экономичным способом минимизации перегрузки является подача тока питания во время переключения лишь на две фазы двигателя (это время можно контролировать при помощи реле времени):

$$Mg_2 = 0.5 \times Mg_3$$

Mg_2 Крутящий момент при подаче питания на две фазы

Mg_3 Крутящий момент при подаче питания на три фазы

с) Радиальные нагрузки

Убедитесь, что радиальные нагрузки на входной и/или выходной вал находятся в пределах допустимых значений по каталогу. В случае превышения допустимой нагрузки выберите редуктор большего размера или измените конструкцию несущей системы. Следует учитывать, что значения, указанные в каталоге относятся к нагрузкам, приложенным к середине хвостовика вала. В связи с этим, если нагрузка приложена к другой точке хвостовика, следует в соответствии с инструкциями, данными в настоящем каталоге (см. ниже раздел 22 «РАДИАЛЬНЫЕ НАГРУЗКИ»), произвести перерасчет допустимой нагрузки в зависимости от расстояния от точки выхода хвостовика вала до точки приложения нагрузки.

д) Осевые нагрузки

Осевые нагрузки не должны превышать 20% от радиальной нагрузки на соответствующий вал.

В случае наличия чрезвычайно высоких осевых нагрузок или сочетания высоких осевых и радиальных нагрузок, рекомендуется обратиться за консультацией в Службу технической поддержки Bonfiglioli.

е) Количество включений в час

В случае применения редуктора в механизмах, требующих высокой частотности включений, необходимо рассчитать максимально допустимое количество включений в час под нагрузкой $[Z]$ (вычисляется в соответствии с указаниями, приведенными в разделе «Электродвигатели»). Реальное количество включений в час должно быть меньше рассчитанного таким образом.

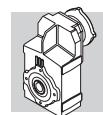

13 – УСТАНОВКА РЕДУКТОРА

При установке редуктора следует соблюдать следующие указания:

- a) Убедитесь в правильности надежности крепления редуктора, исключающей повышенную вибрацию. Если при работе приводимого механизма возможны ударные нагрузки, перегрузки или заклинивание, привод необходимо оборудовать гидравлическими муфтами, системами сцепления, ограничителями момента и т. п.
- b) Перед окрашиванием узла защитите от попадания краски сопрягаемые обработанные поверхности, а также наружные поверхности сальников в целях предотвращения нарушения герметизации вследствие высыхания резины.
- c) Детали, монтируемые на выходной вал редуктора должны иметь допуски ISO H7 для предотвращения посадки с натягом, что может повредить редуктор. Для монтажа и демонтажа таких деталей необходимо пользоваться специальными оправками и съемниками, вворачивающимися в резьбовое отверстие на торце хвостовика вала.
- d) Соединяющиеся поверхности должны быть очищены и обработаны соответствующими защитными средствами для предотвращения окисления и как следствие заклинивание частей.
- e) Перед пуском мотор-редуктора убедитесь, что все элементы механизма, частью которого он является, соответствуют требованиям последней редакции Директивы ЕС о машинах и механизмах 89/392.
- f) Перед пуском механизма убедитесь, что уровень масла соответствует рабочему положению редуктора, а вязкость применяемого масла соответствует предъявляемым требованиям.
- g) При установке мотор-редуктора вне помещения необходимо обеспечить соответствующую защиту привода от атмосферных осадков и прямых солнечных лучей..

Присоединение сервомоторов к редукторам, используя зажимное устройство (адаптер типа SC)

Вращайте зажимное устройство пока его паз не выровняется в линию с пазом на входном валу редуктора. Если вал двигателя имеет шпоночный паз, шпонка должна быть вынута и соответственный шпоночный паз должен быть выровнен с пазами зажимного устройства и входного вала редуктора, перед установкой сервомотора. Шпонка должна находиться на той же стороне что и стопорный винт. Затяните болты, которые соединяют сервомотор с редуктором, вставьте гаечный ключ с ограничителем момента через отверстие на фланце и затяните стопорный винт зажимного устройства до момента, который указан на чертеже данного адаптера.

14 – ХРАНЕНИЕ РЕДУКТОРОВ

В целях обеспечения правильного хранения поставленного оборудования необходимо соблюдать следующие указания:

- a) Не допускайте хранения изделий вне помещений, в местах, подверженных погодным воздействиям, и при высокой влажности.
- b) Между полом помещения и складировемым оборудованием прокладывайте деревянные доски или подкладки из других материалов; не допускайте при хранении прямого контакта изделий с полом.
- c) При длительных сроках хранения все обработанные сопрягаемые поверхности, в т. ч. фланцы, валы и муфты должны быть защищены от окисления соответствующим противокоррозионным составом (Mobilgard 248 или аналогичным). Редукторы при длительном хранении заполнить маслом и хранить в положении сапуном вверх. Перед началом эксплуатации привести уровень масла в соответствие с рабочим положением редуктора.

15 – СОСТОЯНИЕ ИЗДЕЛИЙ ПРИ ПОСТАВКЕ

Изделия поставляются в следующем состоянии:

- a) изделия готовы к монтажу в рабочее положение, указанное клиентом в заказе;
- b) изделия испытаны на соответствие спецификациям изготовителя;
- c) обработанные сопрягаемые поверхности изделий не окрашены;
- d) изделия комплектуются болтами и гайками для крепления двигателя;
- e) все редукторы поставляются с пластиковыми защитными футлярами на валах;
- f) изделия оборудованы проушиной для подъема (для некоторых моделей).

16 – СПЕЦИФИКАЦИИ ЛАКОКРАСОЧНОГО ПОКРЫТИЯ

Спецификации лакокрасочного покрытия, наносимого на редукторы и вариаторы (для окрашиваемых моделей) можно получить в филиалах по продажам и у дилеров, поставляющих изделия потребителям.

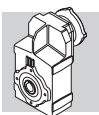

17 – КОНСТРУКТИВНЫЕ ОСОБЕННОСТИ

Основные конструктивные особенности:

- модульный принцип конструкции
- компактность
- универсальное крепление
- высокий КПД
- низкий уровень шума
- шестерни из закалённой стали с цементированием
- редукторы типоразмеров 10, 20, 25 имеют неокрашенные алюминиевые корпуса; редукторы больших типоразмеров имеют прочный корпус из чугуна, окрашенный порошковой эпоксидной краской

(B1)

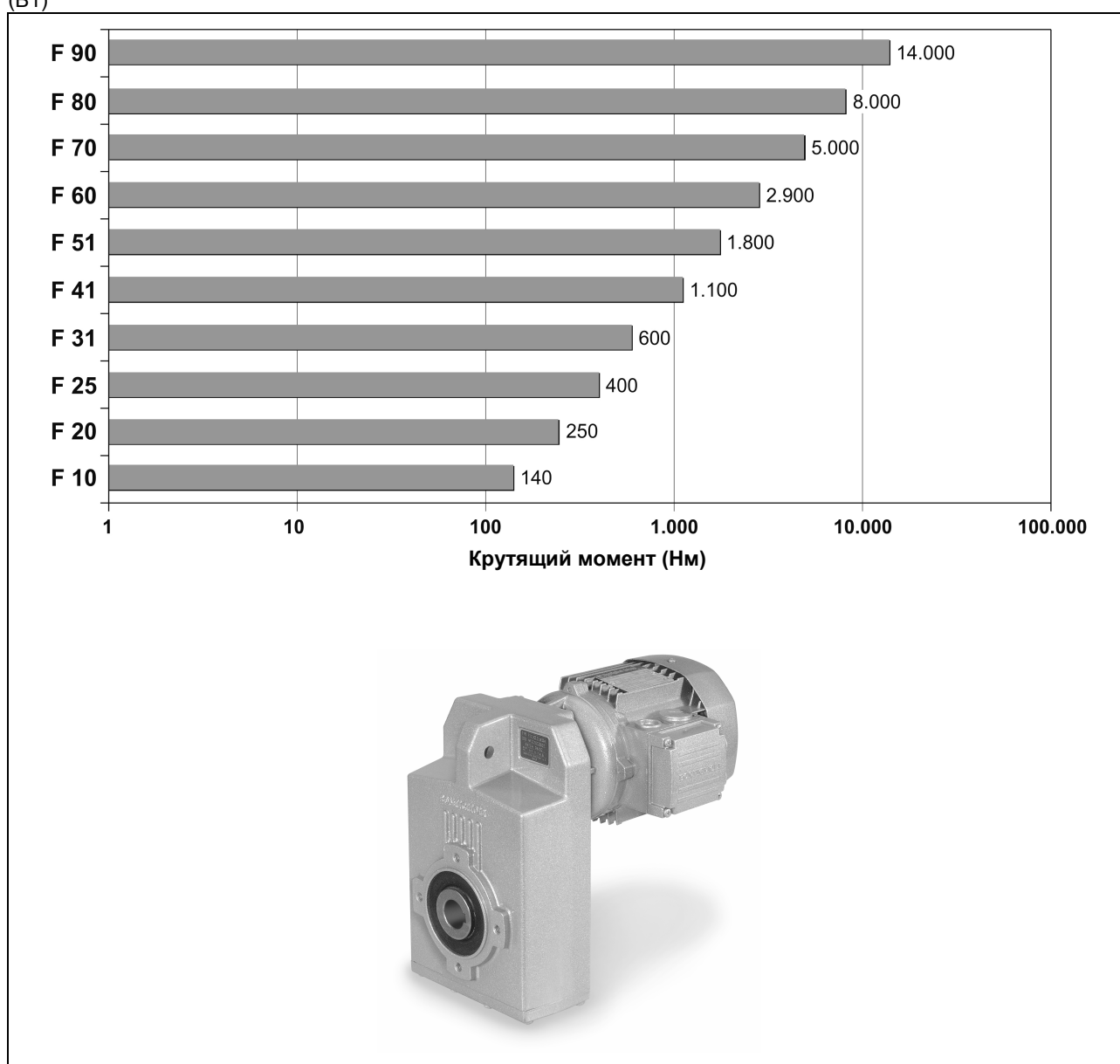

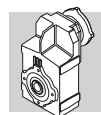

18 – ВАРИАНТЫ ИСПОЛНЕНИЯ

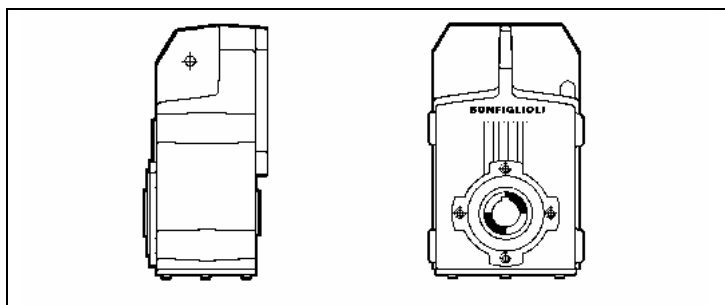

H

Полый выходной вал с пазом под шпонку

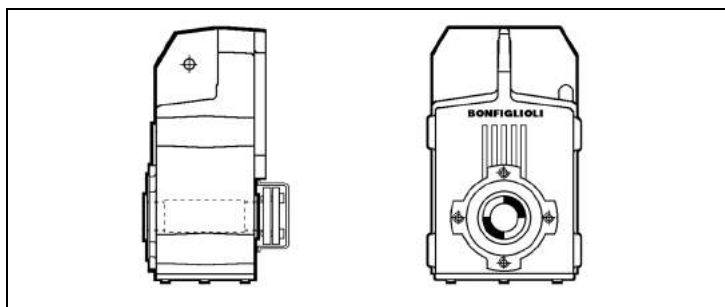

S

Полый выходной вал с зажимным диском

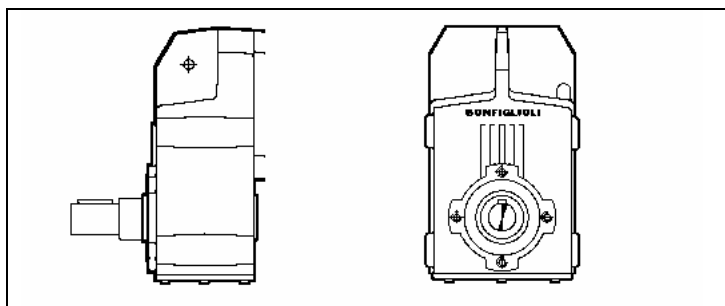

R

Цельный выходной вал

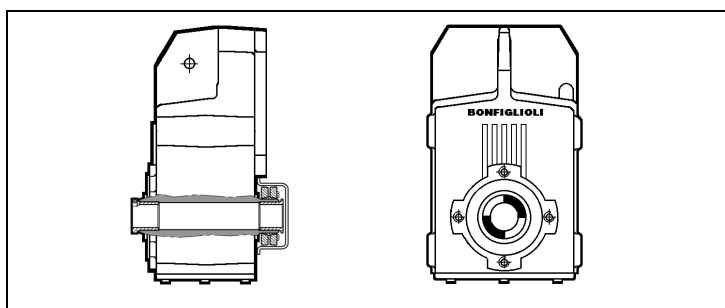

QF

Полый вал с переходными втулками и зажимным диском

Основные варианты исполнения со съемными фланцами

На рисунках ниже показаны основные варианты редукторов со съемными фланцами..

F H

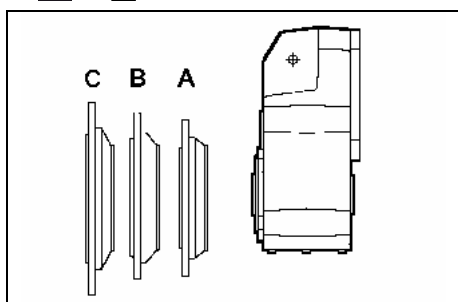

F S

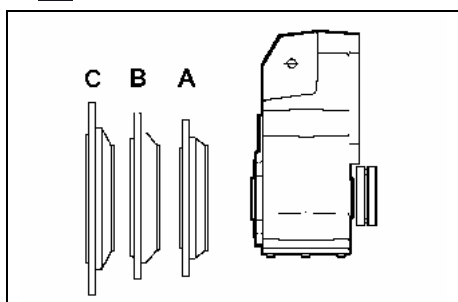

F R

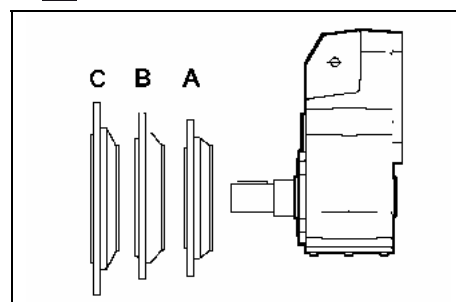

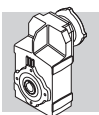

19 – ИДЕНТИФИКАЦИОННАЯ МАРКИРОВКА

РЕДУКТОР

F 10 2 H30 FA 48.7 S1 H5

F ТИП ИЗДЕЛИЯ: F = геликоидальный редуктор, монтируемый на вал

10 ТИПОРАЗМЕР РЕДУКТОРА: 10, 20, 25, 31, 41, 51, 60, 70, 80, 90

2 КОЛИЧЕСТВО СТУПЕНЕЙ РЕДУКЦИИ: 2 (F 10...F 51), 3 (F 20...F 90), 4 (F 31...F 90)

H30 ВАРИАНТ ИСПОЛНЕНИЯ

H										
	F 10	F 20	F 25	F 31	F 41	F 51	F 60	F 70	F 80	F 90
Стандартный	H25	H30	H35	H35	H40	H50	H60	H80	H90	H100
Альтернативный	H30	H35	H40	H40	H45	H55	H70	H70	H80	H90

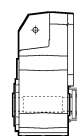

S

(F 10...F 90)

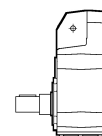

R

(F 10...F 90)



QF

(F 10...F 60)

← Другие диаметры по запросу

FA РАЗМЕР ФЛАНЦА НА ВЫХОДЕ (только по запросу)

F = Исполнение с фланцем

A, B, C = Размер фланца

48.7 ПЕРЕДАТОЧНОЕ ЧИСЛО

S1 КОНФИГУРАЦИЯ НА ВХОДЕ



S05 ... S5



P63 ... P250



SK_



SC_



HS

H5 МОНТАЖНОЕ ПОЛОЖЕНИЕ
H1 (стандарт), H2, H3, H4, H5, H6

18

.... ОПЦИИ

16

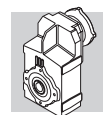

Идентификационная маркировка электродвигателя

ЭЛЕКТРОДВИГАТЕЛЬ

ТОРМОЗ

M	1LA	4	230/400-50	IP54	CLF	W	FD	7.5	R	SB	220	SA
----------	------------	----------	-------------------	-------------	------------	------	----------	-----------	------------	----------	-----------	------------	-----------	------

M	ТИП ДВИГАТЕЛЯ M = компакт 3-фазы BN = IEC 3-фазы
----------	--

1LA	РАЗМЕР ДВИГАТЕЛЯ 05A - 5LA (компактный двигатель) 63A - 250M (IEC двигатель)
------------	--

4	КОЛИЧЕСТВО ПОЛЮСОВ 2, 4, 6, 2/4, 2/6, 2/8, 2/12, 4/6, 4/8
----------	---

230/400-50	НАПРЯЖЕНИЕ/ЧАСТОТА	
-------------------	--------------------	--

IP54	степень защиты IP55 стандартное исполнение (для двигателей с тормозом IP54)	
-------------	---	--

CLF	класс изоляции CL F стандарт CL H опция	
------------	---	--

....	Монтаж мотора — (компактное исполнение) B5 (IEC – мотор)
------	---

W	положение соединительной коробки W (стандарт), N, E, S	
----------	---	--

FD	тип тормоза FD (постоянного тока) FA, BA (переменного тока)			
-----------	---	--	--	--

7.5	тормозной момент			
------------	------------------	--	--	--

R	рычаг ручной разблокировки тормоза Варианты R, RM	
----------	---	--

SB	Тип выпрямителя NB, SB, NBR, SBR	
-----------	--	--

220 SA	Электропитание тормоза			
---------------	------------------------	--	--	--

....	Опции	
------	-------	--

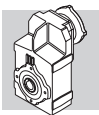

Опции для редукторов

AL, AR

Антиреверсное устройство (стопор обратного хода).

SO

Редукторы F 10 ... F 41, обычно заполняемые на заводе смазкой на весь период эксплуатации, поставляются без смазки.

LO

Редукторы F 51 ... F 90, обычно поставляемые без смазки, поставляются заполненными долговечным синтетическим маслом, в количестве, соответствующем указанному в заказе рабочему положению.

DV

Двойные сальники на входном валу. Опция предусмотрена только для редукторов, сочленяемых с компактными интегральными электродвигателями.

VV

Сальники из специального материала «Viton»® на входном валу.

PV

Сальники из специального материала «Viton» ® на входном и выходном валах.

FL

Обработанные плоскости с отверстиями для монтажа на боковых поверхностях (для редукторов F10 ... F 41).
(Стандартное исполнение для редукторов F 51 ... F 90).

Опции для электродвигателей

AA, AC, AD

Угол расположения рычага ручной разблокировки тормоза относительно соединительной коробки (вид со стороны вентилятора электродвигателя).

При отсутствии иных указаний рычаг ручной разблокировки тормоза (для электродвигателей с тормозом и устройством ручной разблокировки) располагается под углом 90° по часовой стрелке к месту расположения соединительной коробки (расположение АВ). Иной угол расположения в соответствии с имеющимися опциями указывается в заказе. Стандартное исполнение = 90° по часовой стрелке. AA = 0°, AC = 180°, AD = 90° против часовой стрелки.

AL, AR

Антиреверсное устройство – стопор обратного хода (только для электродвигателей серии M).

Стопор вращения против часовой стрелки для редукторов с 2 и 4 степенями редукции и вращения по часовой стрелке для редукторов с 3 степенями редукции (вид со стороны выходного вала редуктора).

(B2)

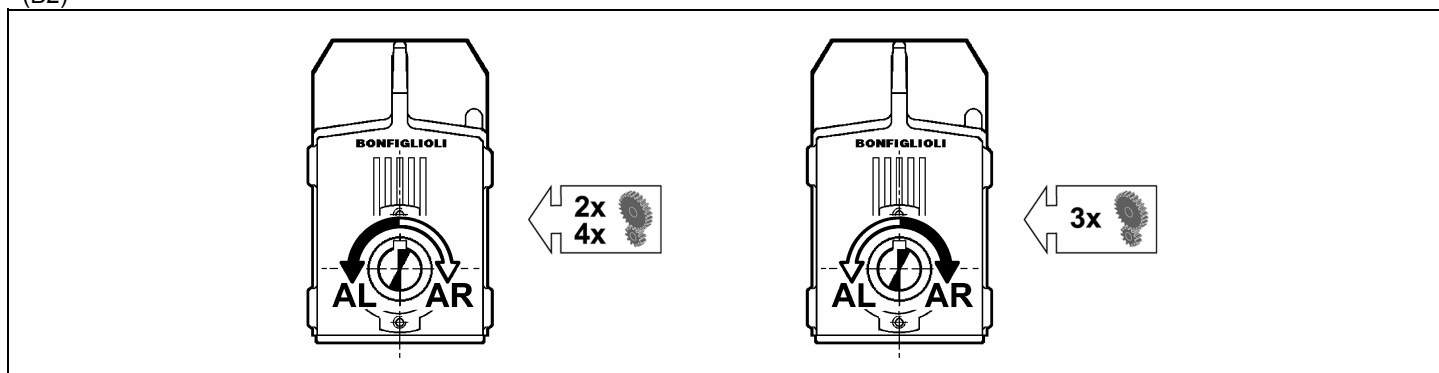

CF

Емкостный фильтр.

D3

Биметаллические предохранители (3 шт.).

E3

Термисторы (3 шт.) для односкоростных и двухскоростных электродвигателей (в соответствии с классом изоляции).

F1

Маховик плавного разгона и остановки.

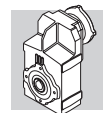

H1
Противоконденсатные нагреватели. Стандартное напряжение питания 230В± 10%.

PN
Для электродвигателей, работающих от сети частотой 60 Гц, указывается нормированная мощность, приведенная к значению при питании электродвигателя от сети с частотой 50 Гц.

PS
Двусторонний выходной вал (опция не совместима с вариантами исполнения RC и U1).

RC
Защитный колпак (опция несовместима с опцией PS).

RV
Балансировка ротора по классу вибрации R.

TC
Исполнение TC является вариантом исполнения электродвигателя с защитным колпаком, предназначенным для применения в текстильной промышленности. Данная опция не применима к электродвигателям с двусторонним валом привода (модификация PS), двигателям в исполнениях EN1, EN2 и EN3, а также к двигателям с тормозом BA.

TP
Тропикализация.

U1
Принудительное охлаждение (опция несовместима с опциями PS и CUS).

U2
Принудительное охлаждение с автономным питанием без отдельной клеммной коробки. Подключение проводников выполнено при сборке. Опция не совместима с опциями PS и CUS. Исполнение возможно для электродвигателей BN 71 ... BN 132, M1 ... M4.

Более подробные сведения об опциях электродвигателей см. в разделе «Электродвигатели» настоящего каталога.

20 - СМАЗКА

Редукторы Bonfiglioli имеют комбинированную систему смазки с использованием методов погружения и разбрызгивания. Редукторы F 10 ... F 41 поставляются изготовителем и авторизованными дилерами заправленными маслом. В комплект поставки редукторов этих типоразмеров в исполнении с фланцем для двигателя IEC входит пробка-сапун, которая перед началом эксплуатации редуктора устанавливается пользователем на место транспортной заглушки.

Редукторы типоразмеров F 51 и выше в стандартном исполнении поставляются без масла. Масло в такие редукторы заливается пользователями перед началом эксплуатации редуктора.

В приведенных ниже таблицах указано расположение маслозаливных и сливных пробок (при их наличии) в картере редуктора, а также необходимое количество масла в зависимости от рабочего положения редуктора.

Приведенные в таблице данные о заправочных емкостях носят справочный характер; окончательный контроль уровня масла производится пользователем через смотровое окно в корпусе редуктора или при помощи маслоизмерительного щупа (при его наличии).

В некоторых случаях может наблюдаться значительное отличие реально требуемого количества масла от указанного в таблице.

При отсутствии посторонних примесей долговечное масло на полигликолевой основе, заливаемое в редуктор на заводе, не требует замены в течение всего периода эксплуатации изделия.

Функционирование редукторов допустимо при температурах между -20°C и +40°C.

Однако, при температурах между -20°C и -10°C запуск возможен, только если оборудование было постепенно и равномерно прогрето, либо вначале функционировало со снятой нагрузкой.

Возможно подключение нагрузки к выходному валу, при достижении редуктором температуры -10°C, или выше.

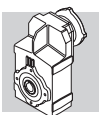

(B3)

Вязкость масла по ISO VG					
	$T_a \leq -20^\circ$	$-20^\circ < T_a \leq 10^\circ$	$0^\circ \leq T_a \leq 30^\circ$	$20^\circ \leq T_a \leq 40^\circ$	$T_a > 40^\circ$
Mineral EP	(*)	150	320	460	460 (*)
PAO EP	(*)	150	220	320	460 (*)
PAG	(*)	150	220	320	460 (*)



PAO Полиальфаолефиновое синтетическое масло

PAG Синтетическое масло на полигликольевой основе

(*) обратитесь в службу технической поддержки Bonfiglioli

Количество масла [l]

(B4)

	 [l]					
	H1	H2	H3	H4	H5	H6
F 10 2	1.1	1.2	0.65	0.65	0.80	0.90
F 20 2	1.9	1.6	0.85	1.1	1.2	1.5
F 20 3	2.0	1.9	1.3	1.3	1.7	1.8
F 25 2	2.1	2.0	2.0	1.5	2.4	2.0
F 25 3	2.0	1.9	1.9	1.5	2.3	2.0
F 25 4	2.2	2.2	2.3	1.6	2.9	2.3
F 31 2	2.7	2.7	1.6	1.6	2.6	2.6
F 31 3	2.6	2.6	1.5	1.6	2.5	2.6
F 31 4	2.8	2.9	1.9	1.7	3.1	2.9
F 41 2	5.1	5.8	3.0	3.3	4.9	4.7
F 41 3	5.0	5.6	4.6	3.1	4.8	4.6
F 41 4	5.6	6.3	4.8	3.8	5.7	5.1
F 51 2	10	7.4	8.4	5.5	9.2	8.2
F 51 3	9.7	7.1	10	5.2	8.9	8.2
F 51 4	9.7	7.4	8.1	5.1	9.9	7.4
F 60 3	15	11	7.8	11	15	11
F 60 4	15	12	8.0	11	15	11
F 70 3	21	20	10	16	20	16
F 70 4	22	18	10	16	25	16
F 80 3	38	32	15	27	41	31
F 80 4	38	34	16	29	48	31
F 90 3	65	55	28	50	75	55
F 90 4	66	55	29	50	85	55

 Смазка на все время эксплуатации

21 – РАБОЧЕЕ ПОЛОЖЕНИЕ РЕДУКТОРА И КЛЕММНОЙ КОРОБКИ

В заказе может быть указано расположение соединительной коробки (вид со стороны вентилятора электродвигателя). Стандартное расположение показано на рисунке черным (W).

Угол расположения рычага ручной разблокировки тормоза.

При отсутствии иных указаний рычаг ручной разблокировки тормоза (для электродвигателей с тормозом и устройством ручной разблокировки) располагается под углом 90° по отношению к месту расположения соединительной коробки (расположение АВ). Иной угол расположения в соответствии с имеющимися опциями указывается в заказе.

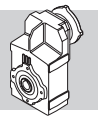

Условные обозначения	
	Наливная пробка/сапун
	Пробка контроля уровня
	Сливная пробка

(B5)

HS

P (IEC)

S

H1

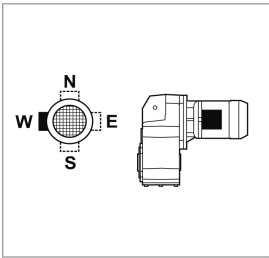
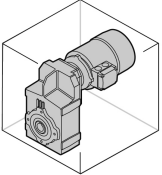

W = Default

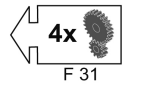
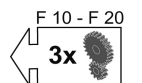
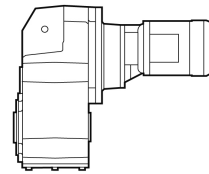
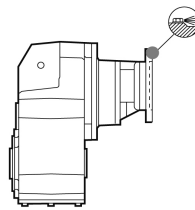
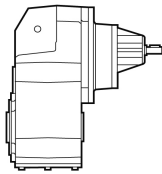
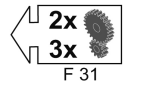
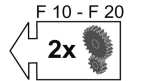
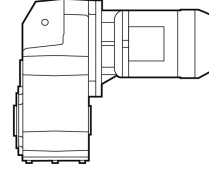
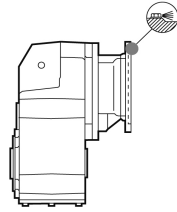
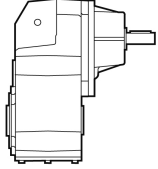

H2

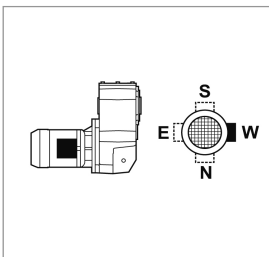
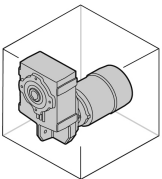

W = Default

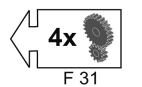
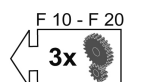
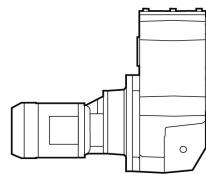
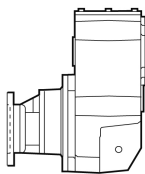
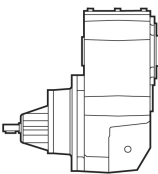
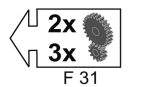
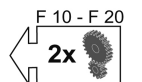
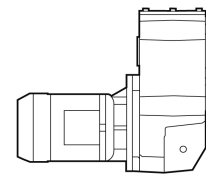
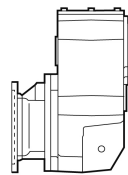
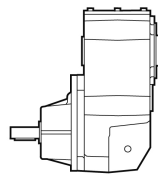

H3

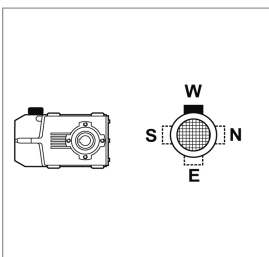
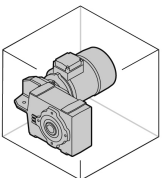

W = Default

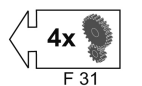
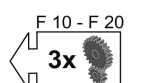
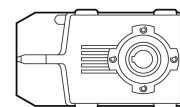
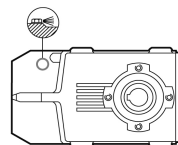
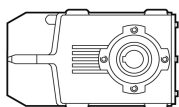
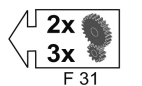
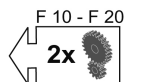
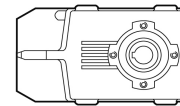
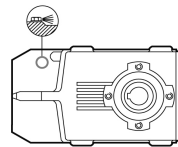
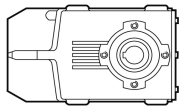

W = стандартное исполнение

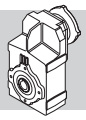

F 10 ... F 31

(B6)

HS

P (IEC)

S

H4

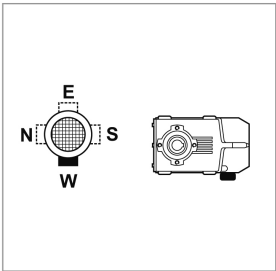
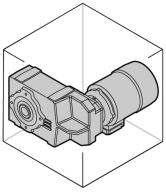

W = Default

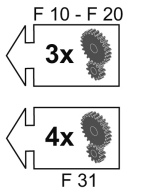
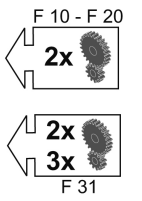
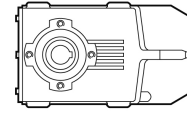
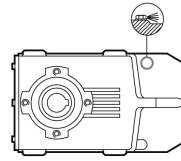
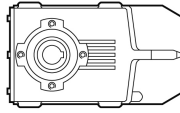

H5

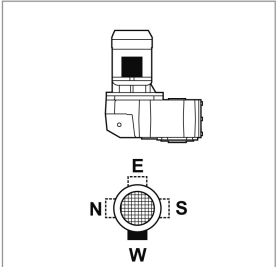
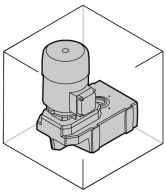

W = Default

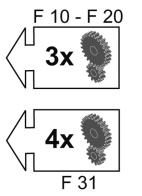
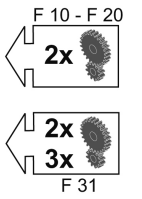
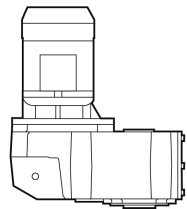
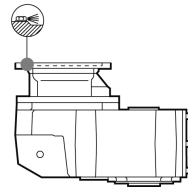
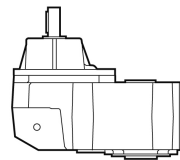

H6

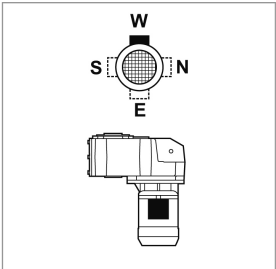
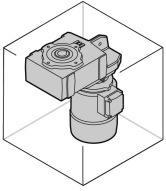

W = Default

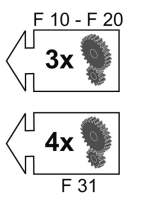
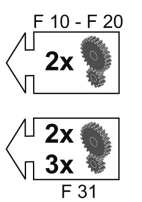
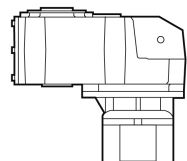
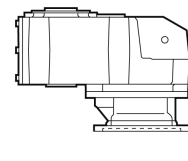
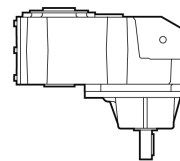

W = стандартное исполнение

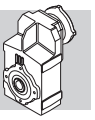

(B7)

HS

P (IEC)

S

H1

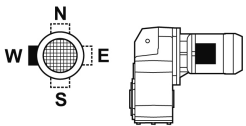
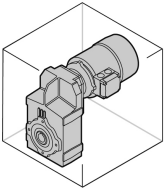

W = Default

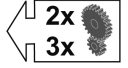
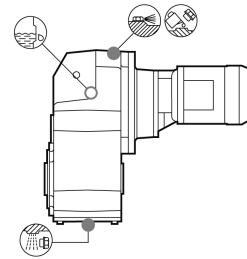
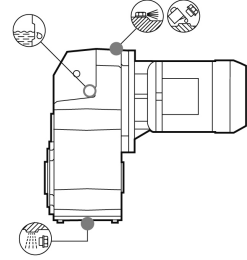
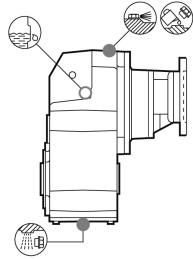
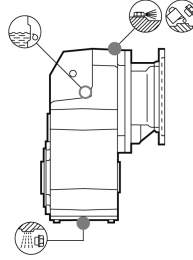
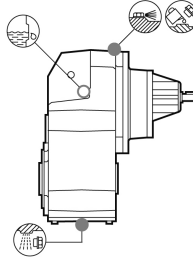
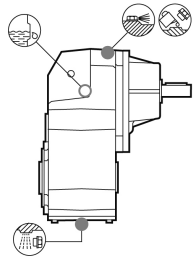

H2

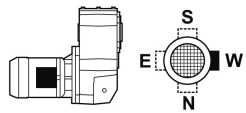
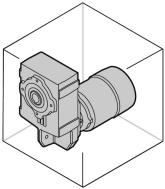

W = Default

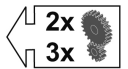
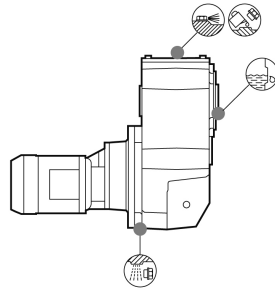
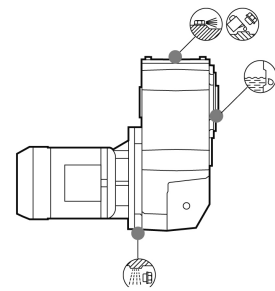
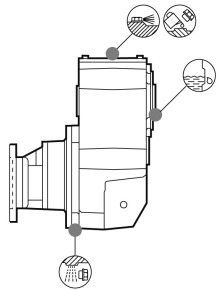
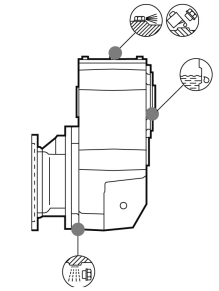
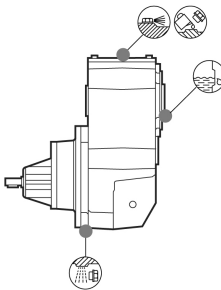
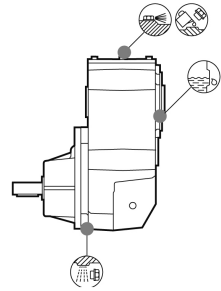

H3

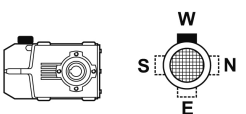
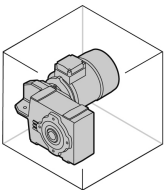

W = Default

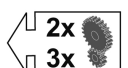
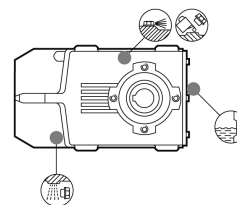
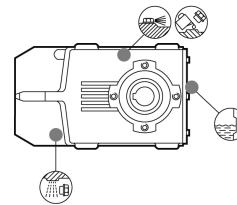
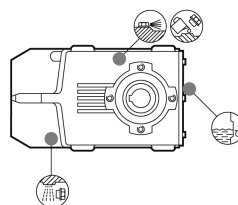
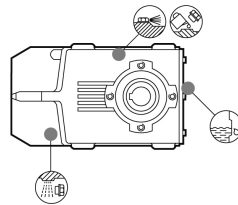
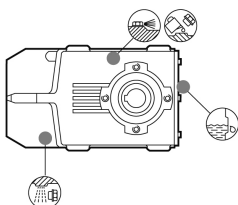
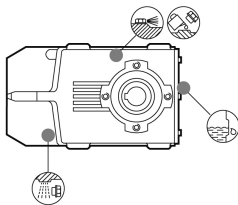

W = стандартное исполнение

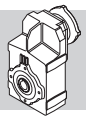

F 41 ... F 60

(B8)

HS

P (IEC)

S

H4

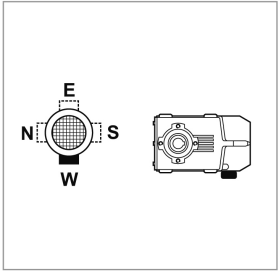
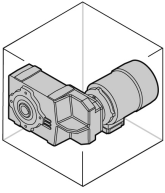

W = Default

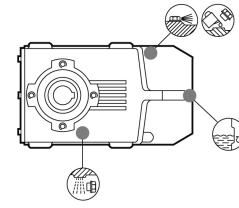
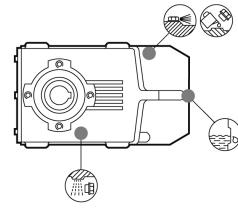
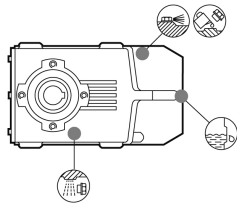

2x
3x

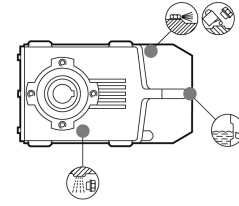
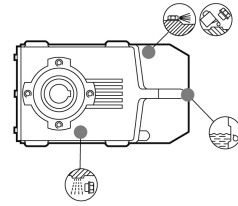
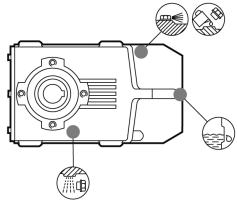

4x

H5

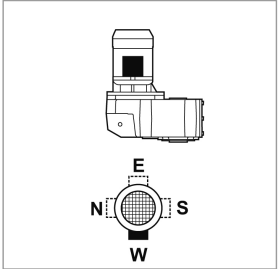
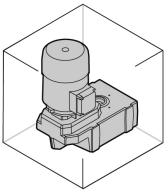

W = Default

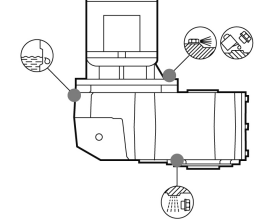
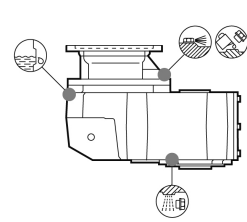
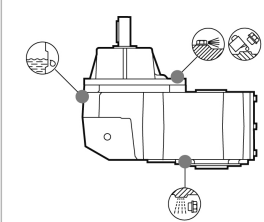

2x
3x

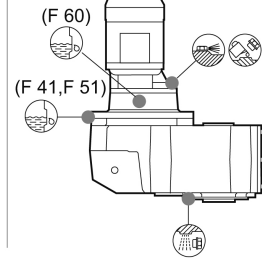
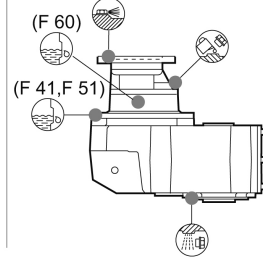
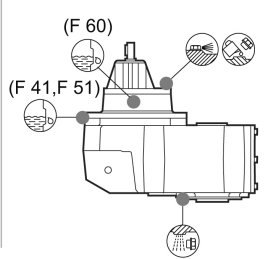

4x

H6

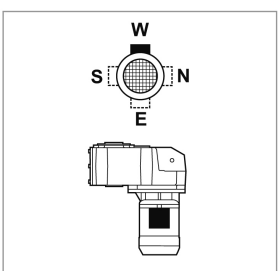
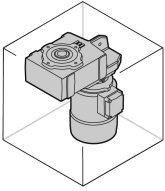

W = Default

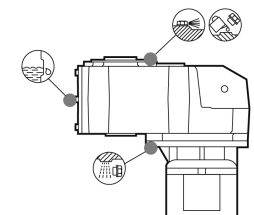
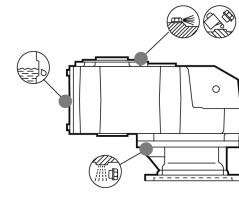
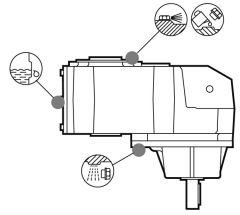

2x
3x

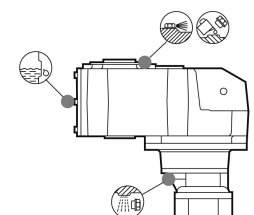
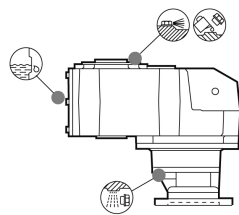
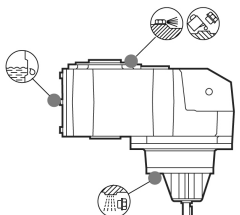

4x

W = стандартное исполнение

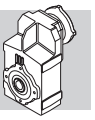

(B9)

HS

P (IEC)

S

H1

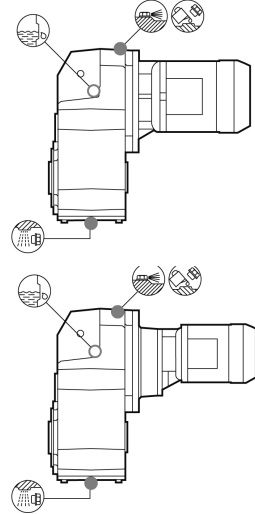
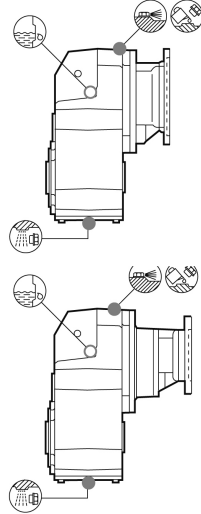
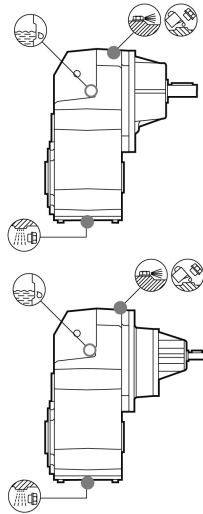
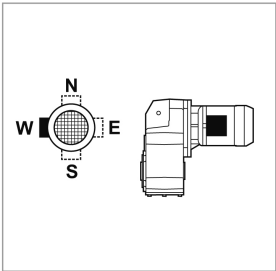
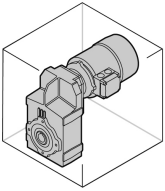

H2

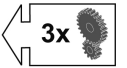
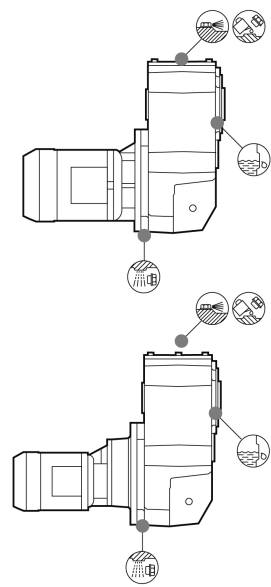
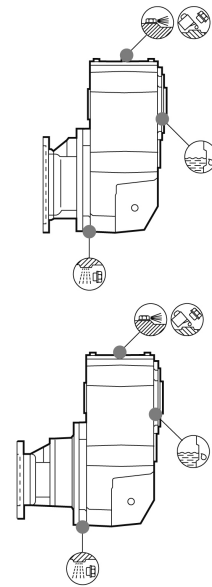
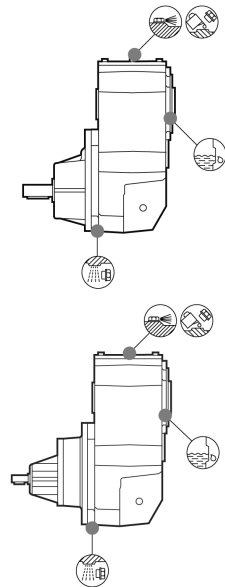
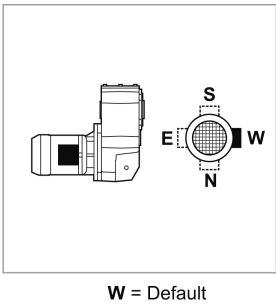
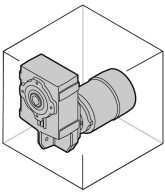

H3

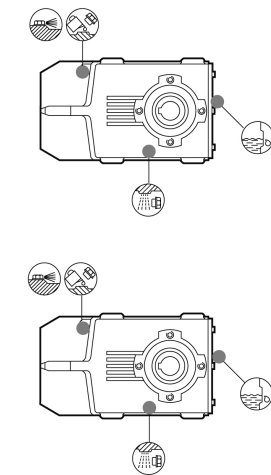
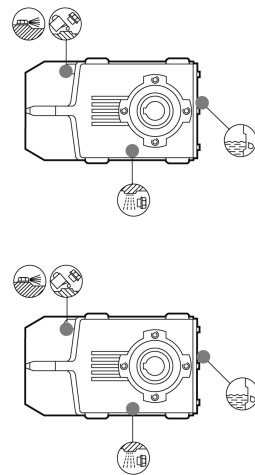
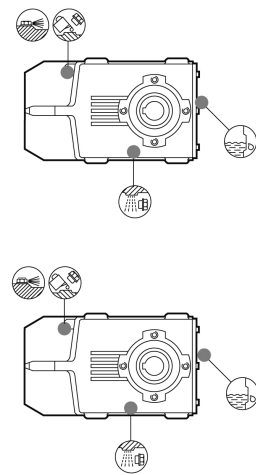
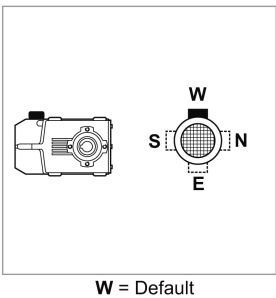
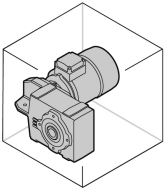

W = стандартное исполнение

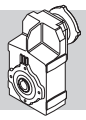

F 70 ... F 90

(B10)

HS

P (IEC)

S

H4

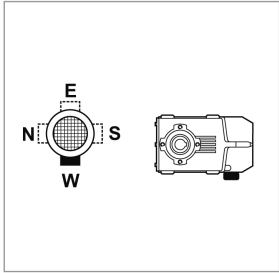
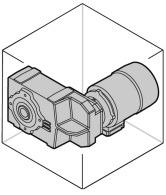

W = Default

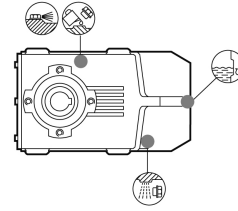
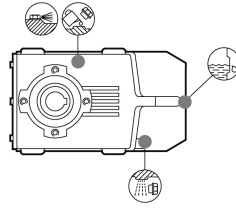
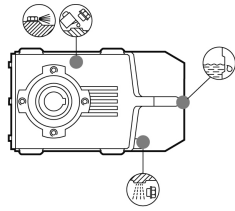

3x

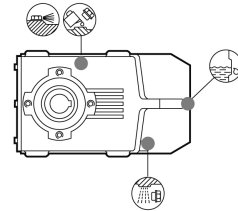
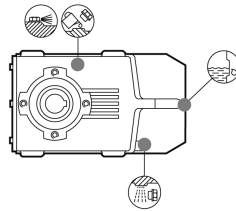
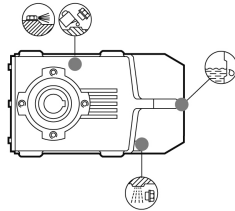

4x

H5

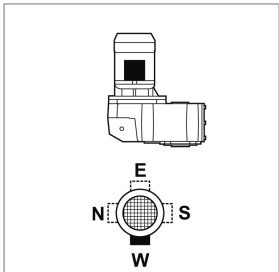
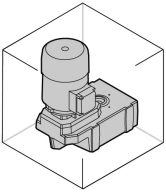

W = Default

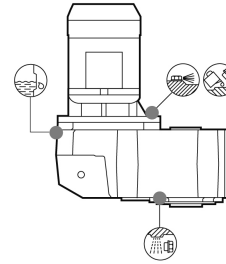
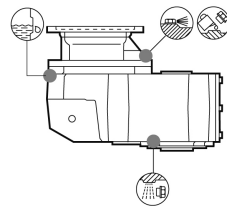
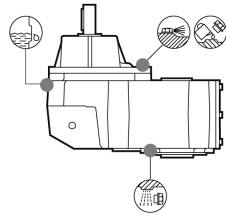

3x

(P63...132)

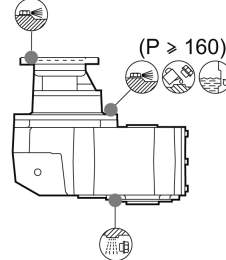

(P > 160)

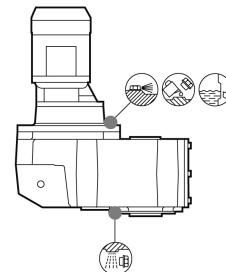

4x

H6

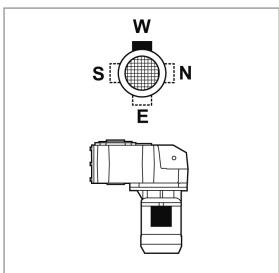
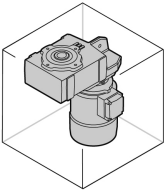

W = Default

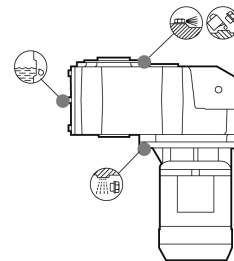
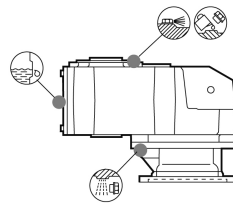
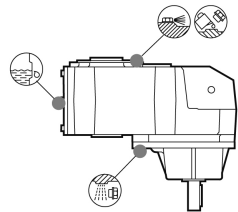

3x

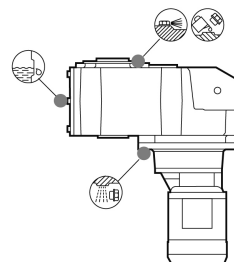
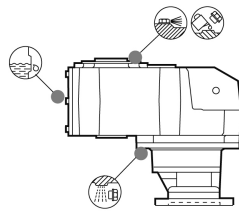
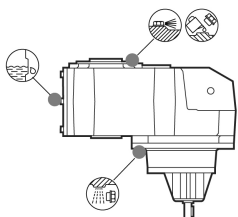

4x

W = стандартное исполнение

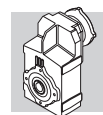

22 – РАДИАЛЬНЫЕ НАГРУЗКИ

Элементы привода, сочлененные с входным и/или выходным валом, создают силы, равнодействующая которых перпендикулярна оси вала. Величина этих сил не должна превышать способности вала и системы подшипников выдерживать действие таких сил.

В частности, абсолютная фактическая величина нагрузок R_{c1} , приложенных к входному валу, и R_{c2} , приложенных к выходному валу, должна быть меньше или равна величине допустимой нагрузки R_{n1} для входного вала и R_{n2} для выходного вала, указанных в таблицах технических характеристик. В приводимых ниже формулах индекс (1) относится к параметрам входного вала, а индекс (2) относится к параметрам выходного вала.

Нагрузку, создаваемую внешним приводом, можно с достаточной точностью вычислить, пользуясь приведенными ниже формулами, относящимися соответственно к входному и выходному валу:

$$R_{c1} [N] = \frac{2000 \cdot M_1 [Nm] \cdot K_r}{d [mm]} \quad ; \quad R_{c2} [N] = \frac{2000 \cdot M_2 [Nm] \cdot K_r}{d [mm]} \quad (15)$$

M_1 [Нм]	Кутящий момент, приложенный к входному валу
M_2 [Нм]	Кутящий момент, приложенный к выходному валу
d [мм]	максимальный диаметр сочлененного с валом компонента привода
$K_r = 1$	коэффициент для цепной передачи
$K_r = 1,25$	коэффициент для шестеренной передачи
$K_r = 1,5$	Клиноременная передача
$K_r = 2,0$	Плоскорременная передача

Процедура проверки будет различной в зависимости от точки приложения нагрузки к валу, а именно в зависимости от того, приложена ли нагрузка к середине хвостовика вала или точка ее приложения удалена от плеча вала на расстояние x :

(B11)

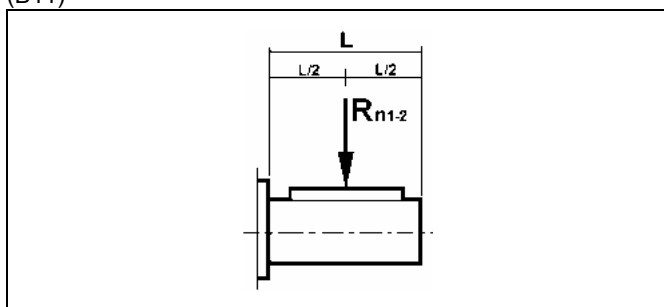

(B12)

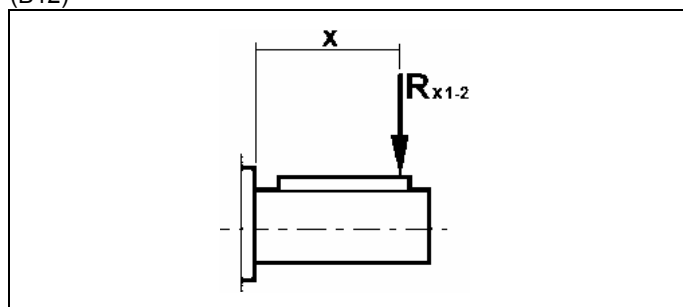

а) Нагрузка, приложенная к срединной точке хвостовика вала (рис. (B11))

Результат вычисления фактической нагрузки сравнивается с приведенной в каталоге соответствующей величиной допустимой нагрузки. При этом для нагруженного вала должно выполняться следующее условие:

$$R_{c1} \leq R_{n1} \text{ [для входного вала]} \text{ и } R_{c2} \leq R_{n2} \text{ [для выходного вала]}$$

б) Нагрузка, приложенная не к срединной точке хвостовика вала (рис. (B12))

Если нагрузка приложена к точке, находящейся на расстоянии x от точки выхода вала из корпуса, величину допустимой нагрузки, приведенную в таблице технических характеристик, следует умножить на поправочный коэффициент, соответствующий расстоянию x . Расчет величины допустимой радиальной нагрузки R_{x1} (для входного вала) и R_{x2} (для выходного вала) производится, соответственно, исходя из номинальных величин R_{n1} и R_{n2} с использованием поправочного коэффициента:

$$\frac{a}{b+x} \quad (16)$$

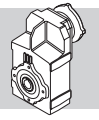

(B13)

	Коэффициенты расположения нагрузки					
	Выходной вал			Входной вал		
	a	b	c	a	b	c
F 10 2	123	100.5	450	21	1	300
F 20 2	145	115	600	40	20	350
F 20 3	145	115	600	21	1	300
F 25 2 – F 25 3	157.5	127.5	800	40	20	350
F 25 4	157.5	127.5	800	21	1	300
F 31 2 – F 31 3	165	135	850	38.5	18.5	350
F 31 4	165	135	850	21	1	300
F 41 2 – F 41 3	191.5	151.5	1000	49.5	24.5	450
F 41 4	191.5	151.5	1000	40	20	350
F 51 2 – F 51 3	233.5	183.5	1300	49.5	24.5	450
F 51 4	233.5	183.5	1300	38.5	18.5	350
F 60 3	258.5	198.5	1100	55.5	25.5	600
F 60 4	258.5	198.5	1100	49.5	24.5	450
F 70 3	342	277	1600	86	31	1000
F 70 4	342	277	1600	49.5	24.5	450
F 80 3	386.5	301.5	1800	86	31	1000
F 80 4	386.5	301.5	1800	49.5	24.5	450
F 90 3	458.5	353.5	2400	116	46	1400
F 90 4	458.5	353.5	2400	49.5	24.5	450

Ниже приводится описание процедуры проверки:

ВХОДНОЙ ВАЛ

1. Вычислить:

$$R_{x1} = R_{n1} \cdot \frac{a}{b+x} \quad (17)$$

N.B. Примечание: для расчета необходимо выполнение следующего условия:

$$\frac{L}{2} \leq x \leq c \quad (18)$$

Проверить выполнение следующего необходимого условия:

$$R_{c1} \leq R_{x1} \quad (19)$$

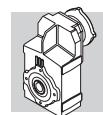

ВЫХОДНОЙ ВАЛ

1. Вычислить:

$$R_{x2} = R_{n2} \cdot \frac{a}{b+x} \quad (20)$$

N.B. Примечание: для расчета необходимо выполнение следующего условия:

$$\frac{L}{2} \leq x \leq c \quad (21)$$

Проверить выполнение следующего необходимого условия:

$$R_{c2} \leq R_{x2} \quad (22)$$

23 – ОСЕВЫЕ НАГРУЗКИ A_{n1} , A_{n2}

Максимальные допустимые величины осевых нагрузок на входной вал [A_{n1}] и на выходной вал [A_{n2}] вычисляются исходя из величин допустимых радиальных нагрузок [R_{n1}] и [R_{n2}] соответственно следующим образом:

$$\begin{aligned} A_{n1} &= R_{n1} \cdot 0,2 \\ A_{n2} &= R_{n2} \cdot 0,2 \end{aligned} \quad (23)$$

Полученные величины относятся к осевым нагрузкам, действующим на валы одновременно с радиальными нагрузками.

В особом случае, когда радиальная нагрузка равна нулю, принимается значение допустимой тяговой нагрузки A_n , равное **50%** допустимой радиальной нагрузки R_n .

Если тяговая нагрузка превышает допустимое значение или величины тяговых нагрузок намного превышают величины радиальных нагрузок, следует обратиться за консультацией в Отдел технической поддержки компании BONFIGLIOLI RIDUTTORI.

24 – АНТИРЕВЕРСНОЕ УСТРОЙСТВО (стопор обратного хода)

В ассортименте имеются редукторы, оснащенные антиреверсным устройством (по специальному заказу: опции AR или AL), исключающим возможность отката и обеспечивающим вращение вала редуктора только в желаемом направлении.

В таблице B14 приведены данные о моделях редукторов, на которые может быть установлено антиреверсное устройство.

(B14)

F 31 2	F 41 2	F 51 2	F 60 3	F 70 3	F 80 3	F 90 3
F 31 3	F 41 3	F 51 3	F 60 4	F 70 4	F 80 4	F 90 4
F 31 4	F 41 4	F 51 4				

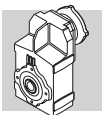

Желаемое направление вращения (правое/левое) выбирается пользователем и должно быть указано в заказе (соответственно, AR или AL).

При отсутствии в заказе указания желаемого направления вращения редуктор поставляется с правым направлением вращения (AR).



Предупреждение. В приводах, где предусмотрено частое срабатывание антиреверсного устройства, момент обратного хода не должен превышать 70% от величины номинального момента M_{n2} для данного редуктора.

(B15)

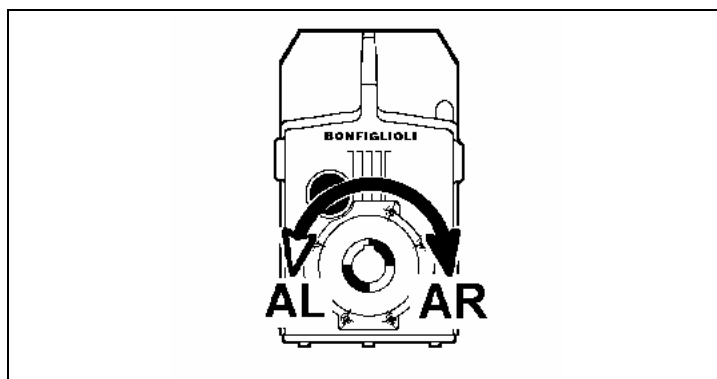
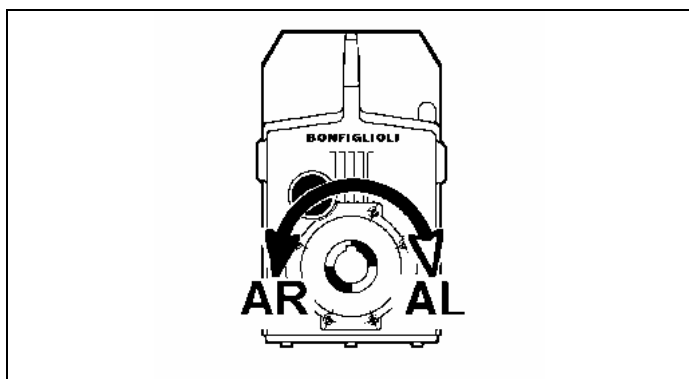

2x		F 31	F 41	F 51				
4x		F 31	F 41	F 51	F 60	F 70	F 80	F 90

3x		F 31	F 41	F 51	F 60	F 70	F 80	F 90
----	--	------	------	------	------	------	------	------

В качестве опции, на все мотор-редукторы оснащенные электродвигателями серии M, на ротор может быть установлено антиреверсное устройство. Описание можно найти в разделе «Электродвигатели» данного каталога.

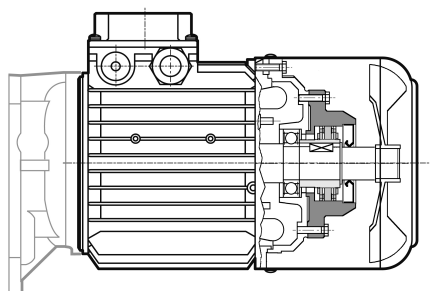

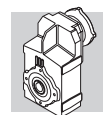

25 - ИНСТРУКЦИИ ПО УСТАНОВКЕ ПЕРЕХОДНЫХ ВТУЛОК – QF

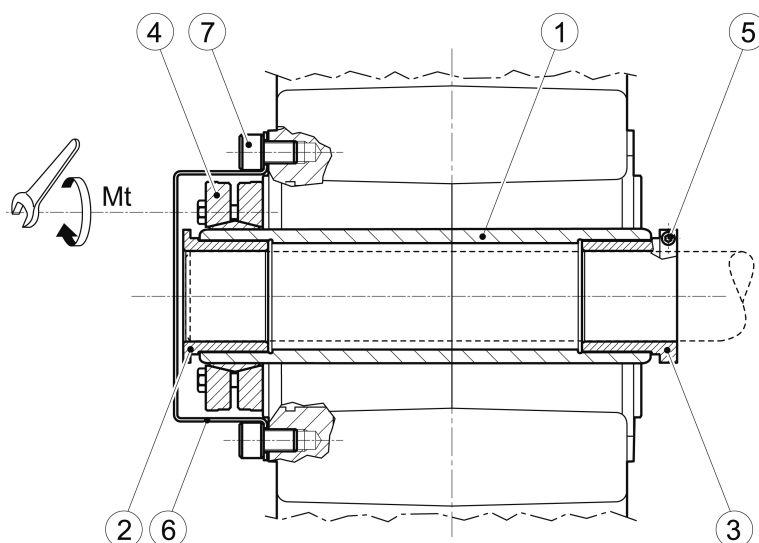

Последовательность установки

- Тщательно очистите и обезжирьте контактирующие поверхности вала приводимого механизма и вала редуктора (1), а также зажима (2), опорных втулок (3) и зажимного диска (4) после снятия со ступицы, на которую он был установлен.
- Вставьте опорную втулку (3) в отверстие в ступице редуктора.
- Присоедините редуктор в сборе с опорной втулкой к валу приводимого механизма и переместите в желаемое положение.
- Переместите зажимную втулку по валу приводимого механизма до упора в отверстие в ступице редуктора.
- Затяните винт (5) опорной втулки с моментом $Mt=6$ Нм, таким образом чтобы втулка плотно закрепилась на валу приводимого механизма.
- Ослабьте винты зажимного диска и установите его на наружный диаметр ступицы редуктора, затем затяните винты с небольшим усилием для того чтобы зажимной диск закрепился на ступице редуктора.
- С помощью гаечного ключа с ограничителем крутящего момента постепенно затяните все винты зажимного диска в круговой последовательности, с моментом указанным в таблице далее.
Рекомендуется достигать максимальное значение момента после трех протяжек.



Максимальное значение момента затяжки выгравировано на наружной поверхности зажимного диска.

(B16)

	F 10	F 20	F 35	F 31	F 41	F 51	F 60
	7 Нм	7 Нм	7 Нм	8 Нм	10 Нм	12 Нм	30 Нм

- В конце установите защиту (6), закрепив ее винтами (7)

Последовательность разборки

- Снимите защиту и ослабьте винты зажимного диска постепенно в круговой последовательности. Не выкручивайте полностью винты!
- После уменьшения давления сжатия, редуктор будет свободно перемещаться по валу приводимого механизма и может быть демонтирован.

ВНИМАНИЕ! Обжимные диски, в которых скопилась грязь или, которые находились длительное время в работе, должны быть разобраны и тщательно очищены при помощи растворителя перед обратной установкой в рабочее положение. Удалите посторонние предметы и нанесите небольшое количество пасты **Molykote G-Rapid Plus** как на контактирующие конические поверхности муфты, так и на резьбу всех затяжных винтов.

Зажимная втулка используется только один раз. В случае снятия данной втулки по каким-либо причинам, она должна быть заменена оригинальной запасной частью.

После трех циклов установки рекомендуется заново наносить пасту Molykote на конические поверхности зажимного диска и заменять винты новыми, того же класса, также с нанесением пасты Molykote.

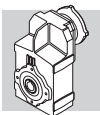

26 – ОПЦИИ И СПЕЦИАЛЬНЫЕ ИСПОЛНЕНИЯ

Боковые монтажные плоскости для крепления (опция FL)

Редукторы серии F по специальному заказу поставляются в корпусах с обработанными боковыми плоскостями и резьбовыми отверстиями для крепления (опция FL).

Монтажные размеры для опции FL приведены в таблице (B17) ниже.

Редукторы типоразмеров F 51 ... F 90 поставляются с обработанными боковыми монтажными плоскостями в стандартном исполнении.

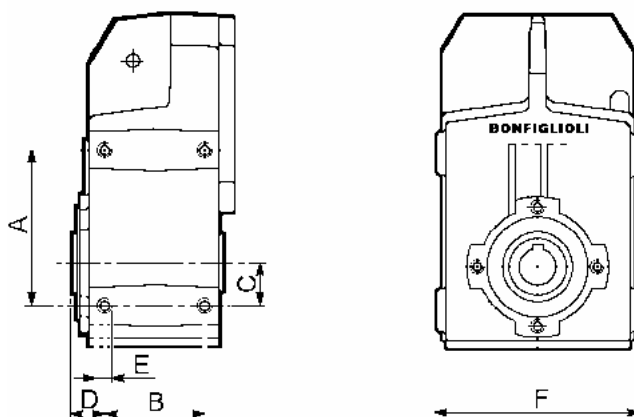

(B17)

	A	B	C	D	E	F
F 10	115	60	35	21.25	M8x16	163
F 20	130	70	40	26.5	M10x20	181
F 25	130	70	40	27.5	M10x20	181
F 31	147	80	45	30	M12x20	203
F 41	190	95	60	32.5	M12x22	235

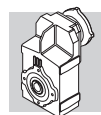

Измененный внутренний диаметр полового выходного вала

По специальным заказам редукторы серии F всех типоразмеров могут поставляться с полыми валами измененного внутреннего диаметра.

Соответствующие размеры приведены в таблице (B18) ниже.

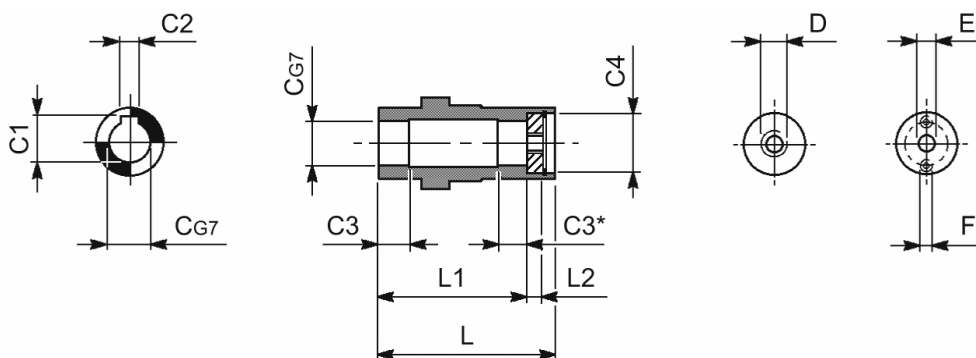



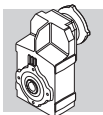

(B18)

	C	C1	C2	C3	C4	L	L1	L2	D	E	F
F 10	30	33.3	8	18/15*	38	100.5	88.5	6	M10	—	—
F 20	35	38.3	10	20	42	120	101	10.3	M10	—	—
F 25	40	43.3	12	25	42	135.5	105.5	10.25	M10	—	—
F 31	40	43.3	12	30	42	125	106	10.5	M10	—	—
F 41	45	48.8	14	30	50	144	120.5	12.5	M12	—	—
F 51	55	59.3	16	35	60	163	141	14.5	M16	—	—
F 60	70	74.9	20	40	75	204	182	14.5	—	17	M12
F 70	70	74.9	20	60	85	261	231	17	—	22	M16
F 80	80	85.4	22	80	95	309	274	18.5	—	22	M16
F 90	90	95.5	25	90	110	367.5	335.5	21	—	26	M16





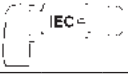

27 – ТАБЛИЦЫ ПАРАМЕТРОВ МОТОР - РЕДУКТОРОВ

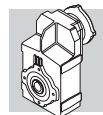
0.09 кВт



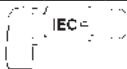

n ₂ МИН-1	M ₂ НМ	S	i	Rn ₂ Н				
0.40	1945	2.6	2188	35000			F 704_2188 P63 BN63A6	127
0.50	1526	3.4	1717	35000			F 704_1717 P63 BN63A6	127
0.62	1254	0.9	1411	8500	F 414_1411 S05 M05A6	114	F 414_1411 P63 BN63A6	115
0.73	1079	1.0	1213	8500	F 414_1213 S05 M05A6	114	F 414_1213 P63 BN63A6	115
0.81	971	1.1	1092	8500	F 414_1092 S05 M05A6	114	F 414_1092 P63 BN63A6	115
0.90	874	1.3	982.4	8500	F 414_982.4 S05 M05A6	114	F 414_982.4 P63 BN63A6	115
0.98	801	1.4	900.5	8500	F 414_900.5 S05 M05A6	114	F 414_900.5 P63 BN63A6	115
1.1	724	1.5	813.8	8500	F 414_813.8 S05 M05A6	114	F 414_813.8 P63 BN63A6	115
1.2	678	0.9	762.3	6500	F 314_762.3 S05 M05A6	110	F 314_762.3 P63 BN63A6	111
1.2	658	1.7	739.4	8500	F 414_739.4 S05 M05A6	114	F 414_739.4 P63 BN63A6	115
1.3	610	1.0	685.6	6500	F 314_685.6 S05 M05A6	110	F 314_685.6 P63 BN63A6	111
1.3	614	1.8	690.1	8500	F 414_690.1 S05 M05A6	114	F 414_690.1 P63 BN63A6	115
1.4	551	1.1	619.9	6500	F 314_619.9 S05 M05A6	110	F 314_619.9 P63 BN63A6	111
1.5	515	1.2	578.6	6500	F 314_578.6 S05 M05A6	110	F 314_578.6 P63 BN63A6	111
1.6	489	2.2	549.8	8500	F 414_549.8 S05 M05A6	114	F 414_549.8 P63 BN63A6	115
1.7	469	0.9	527.3	6500	F 254_527.3 S05 M05A6	106	F 254_527.3 P63 BN63A6	107
1.7	469	1.3	527.8	6500	F 314_527.8 S05 M05A6	110	F 314_527.8 P63 BN63A6	111
1.9	414	1.0	466.0	6500	F 254_466.0 S05 M05A6	106	F 254_466.0 P63 BN63A6	107
1.9	411	1.5	462.6	6500	F 314_462.6 S05 M05A6	110	F 314_462.6 P63 BN63A6	111
2.0	387	1.0	434.9	6500	F 254_434.9 S05 M05A6	106	F 254_434.9 P63 BN63A6	107
2.0	386	2.9	433.7	8500	F 414_433.7 S05 M05A6	114	F 414_433.7 P63 BN63A6	115
2.1	372	1.6	418.9	6500	F 314_418.9 S05 M05A6	110	F 314_418.9 P63 BN63A6	111
2.2	350	1.1	393.9	6500	F 254_393.9 S05 M05A6	106	F 254_393.9 P63 BN63A6	107
2.4	340	1.8	374.4	6500			F 313_374.4 P63 BN63A6	111
2.6	302	2.0	332.8	6500			F 313_332.8 P63 BN63A6	111
2.6	313	3.5	344.8	8500			F 413_344.8 P63 BN63A6	115
2.8	288	0.9	316.9	4000	F 203_316.9 S05 M05A6	102	F 203_316.9 P63 BN63A6	103
3.0	267	2.2	293.8	6500			F 313_293.8 P63 BN63A6	111
3.1	259	1.0	285.2	4000	F 203_285.2 S05 M05A6	102	F 203_285.2 P63 BN63A6	103
3.4	232	1.1	255.3	4000	F 203_255.3 S05 M05A6	102	F 203_255.3 P63 BN63A6	103
3.5	230	2.6	253.6	6500			F 313_253.6 P63 BN63A6	111
3.9	207	2.9	228.2	6500			F 313_228.2 P63 BN63A6	111
4.2	190	1.3	209.3	4000	F 203_209.3 S05 M05A6	102	F 203_209.3 P63 BN63A6	103
4.4	184	3.3	202.3	6500			F 313_202.3 P63 BN63A6	111
4.8	168	1.5	184.9	4000	F 203_184.9 S05 M05A6	102	F 203_184.9 P63 BN63A6	103
5.1	157	1.6	172.6	4000	F 203_172.6 S05 M05A6	102	F 203_172.6 P63 BN63A6	103
5.6	142	1.8	156.3	4000	F 203_156.3 S05 M05A6	102	F 203_156.3 P63 BN63A6	103
6.7	123	2.0	132.2	4000	F 202_132.2 S05 M05A6	102	F 202_132.2 P63 BN63A6	103
6.9	118	1.2	127.1	2800	F 102_127.1 S05 M05A6	98	F 102_127.1 P63 BN63A6	99
7.7	106	2.4	114.3	4000	F 202_114.3 S05 M05A6	102	F 202_114.3 P63 BN63A6	103
8.3	98	1.4	106.0	2800	F 102_106.0 S05 M05A6	98	F 102_106.0 P63 BN63A6	99
8.7	94	2.6	101.6	4000	F 202_101.6 S05 M05A6	102	F 202_101.6 P63 BN63A6	103
9.6	85	1.6	91.5	2800	F 102_91.5 S05 M05A6	98	F 102_91.5 P63 BN63A6	99
9.7	84	3.0	90.4	4000	F 202_90.4 S05 M05A6	102	F 202_90.4 P63 BN63A6	103
10.8	75	1.9	81.3	2800	F 102_81.3 S05 M05A6	98	F 102_81.3 P63 BN63A6	99
11.5	71	3.5	76.8	4000	F 202_76.8 S05 M05A6	102	F 202_76.8 P63 BN63A6	103
12.4	66	2.1	71.1	2800	F 102_71.1 S05 M05A6	98	F 102_71.1 P63 BN63A6	99
14.0	58	2.4	63.0	2800	F 102_63.0 S05 M05A6	98	F 102_63.0 P63 BN63A6	99
15.5	53	2.7	56.7	2800	F 102_56.7 S05 M05A6	98	F 102_56.7 P63 BN63A6	99
18.1	45	3.1	48.7	2800	F 102_48.7 S05 M05A6	98	F 102_48.7 P63 BN63A6	99
19.7	41	3.4	44.7	2800	F 102_44.7 S05 M05A6	98	F 102_44.7 P63 BN63A6	99
22.2	37	3.8	39.6	2800	F 102_39.6 S05 M05A6	98	F 102_39.6 P63 BN63A6	99
24.9	33	4.3	35.3	2800	F 102_35.3 S05 M05A6	98	F 102_35.3 P63 BN63A6	99
26.7	31	4.6	33.0	2800	F 102_33.0 S05 M05A6	98	F 102_33.0 P63 BN63A6	99
29.7	28	5.1	29.6	2800	F 102_29.6 S05 M05A6	98	F 102_29.6 P63 BN63A6	99
34	24	5.9	25.8	2800	F 102_25.8 S05 M05A6	98	F 102_25.8 P63 BN63A6	99
39	21	6.6	22.8	2800	F 102_22.8 S05 M05A6	98	F 102_22.8 P63 BN63A6	99
46	18	7.8	19.3	2800	F 102_19.3 S05 M05A6	98	F 102_19.3 P63 BN63A6	99



0.09 кВт

n_2 мин ⁻¹	M_2 Нм	S	i	R_{n2} Н				
52	16	8.9	17.0	2800	F 102_17.0 S05 M05A6	98	F 102_17.0 P63 BN63A6	99
60	14	10.1	14.6	2700	F 102_14.6 S05 M05A6	98	F 102_14.6 P63 BN63A6	99
68	12	10.3	13.0	2600	F 102_13.0 S05 M05A6	98	F 102_13.0 P63 BN63A6	99
76	11	10.3	11.5	2500	F 102_11.5 S05 M05A6	98	F 102_11.5 P63 BN63A6	99
90	9	11.8	9.8	2370	F 102_9.8 S05 M05A6	98	F 102_9.8 P63 BN63A6	99
103	8	11.8	8.6	2270	F 102_8.6 S05 M05A6	98	F 102_8.6 P63 BN63A6	99
119	7	13.2	7.4	2160	F 102_7.4 S05 M05A6	98	F 102_7.4 P63 BN63A6	99

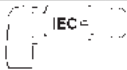
0.12 кВт

n_2 мин ⁻¹	M_2 Нм	S	i	R_{n2} Н				
0.40	2623	1.9	2188	35000			F 704_2188 P63 BN63B6	127
0.51	2058	2.5	1717	35000			F 704_1717 P63 BN63B6	127
0.60	1742	2.9	2188	35000			F 704_2188 P63 BN63A4	127
0.65	1607	3.1	2019	35000			F 704_2019 P63 BN63A4	127
0.76	1368	2.1	1141	20000			F 604_1141 P63 BN63B6	123
0.89	1178	0.9	982.4	8500	F 414_982.4 S05 M05B6	114	F 414_982.4 P63 BN63B6	115
0.96	1090	1.0	1411	8500	F 414_1411 S05 M05A4	114	F 414_1411 P63 BN63A4	115
1.1	938	1.2	1213	8500	F 414_1213 S05 M05A4	114	F 414_1213 P63 BN63A4	115
1.2	844	1.3	1092	8500	F 414_1092 S05 M05A4	114	F 414_1092 P63 BN63A4	115
1.4	759	1.4	982.4	8500	F 414_982.4 S05 M05A4	114	F 414_982.4 P63 BN63A4	115
1.5	696	1.6	900.5	8500	F 414_900.5 S05 M05A4	114	F 414_900.5 P63 BN63A4	115
1.6	643	0.9	831.6	6500	F 314_831.6 S05 M05A4	110	F 314_831.6 P63 BN63A4	111
1.7	629	1.7	813.8	8500	F 414_813.8 S05 M05A4	114	F 414_813.8 P63 BN63A4	115
1.8	589	1.0	762.3	6500	F 314_762.3 S05 M05A4	110	F 314_762.3 P63 BN63A4	111
1.8	571	1.9	739.4	8500	F 414_739.4 S05 M05A4	114	F 414_739.4 P63 BN63A4	115
2.0	530	1.1	685.6	6500	F 314_685.6 S05 M05A4	110	F 314_685.6 P63 BN63A4	111
2.0	533	2.1	690.1	8500	F 414_690.1 S05 M05A4	114	F 414_690.1 P63 BN63A4	115
2.2	479	1.3	619.9	6500	F 314_619.9 S05 M05A4	110	F 314_619.9 P63 BN63A4	111
2.3	456	0.9	589.7	6500	F 254_589.7 S05 M05A4	106	F 254_589.7 P63 BN63A4	107
2.3	447	1.3	578.6	6500	F 314_578.6 S05 M05A4	110	F 314_578.6 P63 BN63A4	111
2.5	425	2.6	549.8	8500	F 414_549.8 S05 M05A4	114	F 414_549.8 P63 BN63A4	115
2.6	408	1.0	527.3	6500	F 254_527.3 S05 M05A4	106	F 254_527.3 P63 BN63A4	107
2.6	408	1.5	527.8	6500	F 314_527.8 S05 M05A4	110	F 314_527.8 P63 BN63A4	111
2.9	360	1.1	466.0	6500	F 254_466.0 S05 M05A4	106	F 254_466.0 P63 BN63A4	107
2.9	358	1.7	462.6	6500	F 314_462.6 S05 M05A4	110	F 314_462.6 P63 BN63A4	111
3.1	336	1.2	434.9	6500	F 254_434.9 S05 M05A4	106	F 254_434.9 P63 BN63A4	107
3.1	335	3.3	433.7	8500	F 414_433.7 S05 M05A4	114	F 414_433.7 P63 BN63A4	115
3.2	324	1.9	418.9	6500	F 314_418.9 S05 M05A4	110	F 314_418.9 P63 BN63A4	111
3.4	304	1.3	393.9	6500	F 254_393.9 S05 M05A4	106	F 254_393.9 P63 BN63A4	107
3.6	296	2.0	374.4	6500			F 313_374.4 P63 BN63A4	111
4.1	263	1.5	333.1	6500	F 253_333.1 S05 M05A4	106	F 253_333.1 P63 BN63A4	107
4.1	263	2.3	332.8	6500			F 313_332.8 P63 BN63A4	111
4.3	250	1.0	316.9	4000	F 203_316.9 S05 M05A4	102	F 203_316.9 P63 BN63A4	103
4.6	232	2.6	293.8	6500			F 313_293.8 P63 BN63A4	111
4.7	225	1.1	285.2	4000	F 203_285.2 S05 M05A4	102	F 203_285.2 P63 BN63A4	103
4.7	228	1.8	288.1	6500	F 253_288.1 S05 M05A4	106	F 253_288.1 P63 BN63A4	107
5.3	202	1.2	255.3	4000	F 203_255.3 S05 M05A4	102	F 203_255.3 P63 BN63A4	103
5.3	202	2.0	256.1	6500	F 253_256.1 S05 M05A4	106	F 253_256.1 P63 BN63A4	107
5.3	200	3.0	253.6	6500			F 313_253.6 P63 BN63A4	111
5.9	180	2.2	227.8	6500	F 253_227.8 S05 M05A4	106	F 253_227.8 P63 BN63A4	107
5.9	180	3.3	228.2	6500			F 313_228.2 P63 BN63A4	111
6.5	165	1.5	209.3	4000	F 203_209.3 S05 M05A4	102	F 203_209.3 P63 BN63A4	103
7.0	153	2.6	193.6	6500	F 253_193.6 S05 M05A4	106	F 253_193.6 P63 BN63A4	107
7.3	146	1.7	184.9	4000	F 203_184.9 S05 M05A4	102	F 203_184.9 P63 BN63A4	103
7.7	138	2.9	174.2	6500	F 253_174.2 S05 M05A4	106	F 253_174.2 P63 BN63A4	107
7.8	136	1.8	172.6	4000	F 203_172.6 S05 M05A4	102	F 203_172.6 P63 BN63A4	103

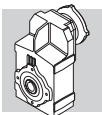

0.12 кВТ



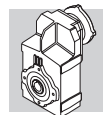

n_2 мин ⁻¹	M_2 Нм	S	i	R_{n2} Н				
8.6	123	2.0	156.3	4000	F 203_156.3 S05 M05A4	102	F 203_156.3 P63 BN63A4	103
8.7	123	3.2	155.9	6500	F 253_155.9 S05 M05A4	106	F 253_155.9 P63 BN63A4	107
9.4	113	3.5	143.0	6500	F 253_143.0 S05 M05A4	106	F 253_143.0 P63 BN63A4	107
10.2	107	2.3	132.2	4000	F 202_132.2 S05 M05A4	102	F 202_132.2 P63 BN63A4	103
10.6	103	1.4	127.1	2800	F 102_127.1 S05 M05A4	98	F 102_127.1 P63 BN63A4	99
11.8	92	2.7	114.3	4000	F 202_114.3 S05 M05A4	102	F 202_114.3 P63 BN63A4	103
12.7	86	1.6	106.0	2800	F 102_106.0 S05 M05A4	98	F 102_106.0 P63 BN63A4	99
13.3	82	3.0	101.6	4000	F 202_101.6 S05 M05A4	102	F 202_101.6 P63 BN63A4	103
14.8	74	1.9	91.5	2800	F 102_91.5 S05 M05A4	98	F 102_91.5 P63 BN63A4	99
14.9	73	3.4	90.4	4000	F 202_90.4 S05 M05A4	102	F 202_90.4 P63 BN63A4	103
16.6	66	2.1	81.3	2800	F 102_81.3 S05 M05A4	98	F 102_81.3 P63 BN63A4	99
19.0	57	2.4	71.1	2800	F 102_71.1 S05 M05A4	98	F 102_71.1 P63 BN63A4	99
21.4	51	2.8	63.0	2800	F 102_63.0 S05 M05A4	98	F 102_63.0 P63 BN63A4	99
23.8	46	3.1	56.7	2800	F 102_56.7 S05 M05A4	98	F 102_56.7 P63 BN63A4	99
27.7	39	3.6	48.7	2800	F 102_48.7 S05 M05A4	98	F 102_48.7 P63 BN63A4	99
30	36	3.9	44.7	2800	F 102_44.7 S05 M05A4	98	F 102_44.7 P63 BN63A4	99
34	32	4.4	39.6	2800	F 102_39.6 S05 M05A4	98	F 102_39.6 P63 BN63A4	99
38	29	4.9	35.3	2800	F 102_35.3 S05 M05A4	98	F 102_35.3 P63 BN63A4	99
41	27	5.3	33.0	2800	F 102_33.0 S05 M05A4	98	F 102_33.0 P63 BN63A4	99
46	24	5.9	29.6	2800	F 102_29.6 S05 M05A4	98	F 102_29.6 P63 BN63A4	99
52	21	6.7	25.8	2800	F 102_25.8 S05 M05A4	98	F 102_25.8 P63 BN63A4	99
59	18	7.6	22.8	2700	F 102_22.8 S05 M05A4	98	F 102_22.8 P63 BN63A4	99
70	16	8.7	19.3	2560	F 102_19.3 S05 M05A4	98	F 102_19.3 P63 BN63A4	99
80	14	9.3	17.0	2450	F 102_17.0 S05 M05A4	98	F 102_17.0 P63 BN63A4	99
92	12	10.1	14.6	2340	F 102_14.6 S05 M05A4	98	F 102_14.6 P63 BN63A4	99
104	11	9.9	13.0	2250	F 102_13.0 S05 M05A4	98	F 102_13.0 P63 BN63A4	99
117	9	10.3	11.5	2160	F 102_11.5 S05 M05A4	98	F 102_11.5 P63 BN63A4	99
138	8	11.3	9.8	2050	F 102_9.8 S05 M05A4	98	F 102_9.8 P63 BN63A4	99
157	7	11.8	8.6	1970	F 102_8.6 S05 M05A4	98	F 102_8.6 P63 BN63A4	99
182	6	12.7	7.4	1870	F 102_7.4 S05 M05A4	98	F 102_7.4 P63 BN63A4	99

0.18 кВТ

n_2 мин ⁻¹	M_2 Нм	S	i	R_{n2} Н				
0.41	3804	1.3	2188	35000	F 704_2188 S1 M1SC6	126	F 704_2188 P71 BN71A6	127
0.45	3511	1.4	2019	35000	F 704_2019 S1 M1SC6	126	F 704_2019 P71 BN71A6	127
0.45	3455	2.3	1987	45000	F 804_1987 S1 M1SC6	129	F 804_1987 P71 BN71A6	130
0.49	3189	2.5	1834	45000	F 804_1834 S1 M1SC6	129	F 804_1834 P71 BN71A6	130
0.52	2985	1.7	1717	35000	F 704_1717 S1 M1SC6	126	F 704_1717 P71 BN71A6	127
0.53	2972	2.7	1709	45000	F 804_1709 S1 M1SC6	129	F 804_1709 P71 BN71A6	130
0.57	2756	1.8	1585	35000	F 704_1585 S1 M1SC6	126	F 704_1585 P71 BN71A6	127
0.57	2744	2.9	1578	45000	F 804_1578 S1 M1SC6	129	F 804_1578 P71 BN71A6	130
0.61	2576	1.9	1481	35000	F 704_1481 S1 M1SC6	126	F 704_1481 P71 BN71A6	127
0.65	2406	3.3	1384	45000	F 804_1384 S1 M1SC6	129	F 804_1384 P71 BN71A6	130
0.66	2378	2.1	1368	35000	F 704_1368 S1 M1SC6	126	F 704_1368 P71 BN71A6	127
0.76	2055	2.4	1182	35000	F 704_1182 S1 M1SC6	126	F 704_1182 P71 BN71A6	127
0.77	2030	0.9	1168	12000	F 514_1168 S1 M1SC6	118	F 514_1168 P71 BN71A6	119
0.79	1985	1.5	1141	20000	F 604_1141 S1 M1SC6	122	F 604_1141 P71 BN71A6	123
0.83	1897	2.6	1091	35000	F 704_1091 S1 M1SC6	126	F 704_1091 P71 BN71A6	127
0.84	1861	1.0	1070	12000	F 514_1070 S1 M1SC6	118	F 514_1070 P71 BN71A6	119
0.85	1832	1.6	1054	20000	F 604_1054 S1 M1SC6	122	F 604_1054 P71 BN71A6	123
0.92	1703	1.1	979.4	12000	F 514_979.4 S1 M1SC6	118	F 514_979.4 P71 BN71A6	119
0.92	1694	3.0	974.4	35000	F 704_974.4 S1 M1SC6	126	F 704_974.4 P71 BN71A6	127
0.94	1667	1.7	958.9	20000	F 604_958.9 S1 M1SC6	122	F 604_958.9 P71 BN71A6	123
1.0	1540	1.2	885.5	12000	F 514_885.5 S1 M1SC6	118	F 514_885.5 P71 BN71A6	119
1.0	1539	1.9	885.1	20000	F 604_885.1 S1 M1SC6	122	F 604_885.1 P71 BN71A6	123
1.0	1564	3.2	899.4	35000	F 704_899.4 S1 M1SC6	126	F 704_899.4 P71 BN71A6	127
1.1	1437	1.3	826.4	12000	F 514_826.4 S1 M1SC6	118	F 514_826.4 P71 BN71A6	119

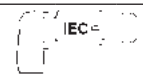

0.18 КВТ

n ₂ МИН-1	M ₂ Нм	S	i	R _{n2} Н				
1.1	1430	3.5	822.2	35000	F 704_822.2 S1 M1SC6	126	F 704_822.2 P71 BN71A6	127
1.2	1286	0.9	739.4	8500	F 414_739.4 S1 M1SC6	114	F 414_739.4 P71 BN71A6	115
1.2	1286	0.9	739.4	8500	F 414_739.4 S1 M1SC6	114	F 414_739.4 P71 BN71A6	115
1.3	1200	0.9	690.1	8500	F 414_690.1 S1 M1SC6	114	F 414_690.1 P71 BN71A6	115
1.3	1200	0.9	690.1	8500	F 414_690.1 S1 M1SC6	114	F 414_690.1 P71 BN71A6	115
1.3	1165	0.9	982.4	8500	F 414_982.4 S05 M05B4	114	F 414_982.4 P63 BN63B4	115
1.5	1068	1.0	900.5	8500	F 414_900.5 S05 M05B4	114	F 414_900.5 P63 BN63B4	115
1.6	965	1.1	813.8	8500	F 414_813.8 S05 M05B4	114	F 414_813.8 P63 BN63B4	115
1.8	877	1.3	739.4	8500	F 414_739.4 S05 M05B4	114	F 414_739.4 P63 BN63B4	115
1.9	818	1.3	690.1	8500	F 414_690.1 S05 M05B4	114	F 414_690.1 P63 BN63B4	115
2.3	686	0.9	578.6	6500	F 314_578.6 S05 M05B4	110	F 314_578.6 P63 BN63B4	111
2.4	652	1.7	549.8	8500	F 414_549.8 S05 M05B4	114	F 414_549.8 P63 BN63B4	115
2.5	626	1.0	527.8	6500	F 314_527.8 S05 M05B4	110	F 314_527.8 P63 BN63B4	111
2.9	549	1.1	462.6	6500	F 314_462.6 S05 M05B4	110	F 314_462.6 P63 BN63B4	111
3.0	514	2.1	433.7	8500	F 414_433.7 S05 M05B4	114	F 414_433.7 P63 BN63B4	115
3.2	497	1.2	418.9	6500	F 314_418.9 S05 M05B4	110	F 314_418.9 P63 BN63B4	111
3.4	467	0.9	393.9	6500	F 254_393.9 S05 M05B4	106	F 254_393.9 P63 BN63B4	107
3.5	454	1.3	374.4	6500			F 313_374.4 P63 BN63B4	111
3.8	418	2.6	344.8	8500			F 413_344.8 P63 BN63B4	115
4.0	404	1.0	333.1	6500	F 253_333.1 S05 M05B4	106	F 253_333.1 P63 BN63B4	107
4.0	403	1.5	332.8	6500			F 313_332.8 P63 BN63B4	111
4.5	356	1.7	293.8	6500			F 313_293.8 P63 BN63B4	111
4.5	359	3.1	296.6	8500			F 413_296.6 P63 BN63B4	115
4.6	349	1.1	288.1	6500	F 253_288.1 S05 M05B4	106	F 253_288.1 P63 BN63B4	107
4.9	323	3.4	266.9	8500			F 413_266.9 P63 BN63B4	115
5.2	310	1.3	256.1	6500	F 253_256.1 S05 M05B4	106	F 253_256.1 P63 BN63B4	107
5.2	307	2.0	253.6	6500			F 313_253.6 P63 BN63B4	111
5.8	276	1.4	227.8	6500	F 253_227.8 S05 M05B4	106	F 253_227.8 P63 BN63B4	107
5.8	277	2.2	228.2	6500			F 313_228.2 P63 BN63B4	111
6.3	254	1.0	209.3	4000	F 203_209.3 S05 M05B4	102	F 203_209.3 P63 BN63B4	103
6.5	245	2.4	202.3	6500			F 313_202.3 P63 BN63B4	111
6.8	235	1.7	193.6	6500	F 253_193.6 S05 M05B4	106	F 253_193.6 P63 BN63B4	107
7.1	224	1.1	184.9	4000	F 203_184.9 S05 M05B4	102	F 203_184.9 P63 BN63B4	103
7.1	225	2.7	185.4	6500			F 313_185.4 P63 BN63B4	111
7.6	209	1.2	172.6	4000	F 203_172.6 S05 M05B4	102	F 203_172.6 P63 BN63B4	103
7.6	211	1.9	174.2	6500	F 253_174.2 S05 M05B4	106	F 253_174.2 P63 BN63B4	107
7.9	202	3.0	166.8	6500			F 313_166.8 P63 BN63B4	111
8.4	189	1.3	156.3	4000	F 203_156.3 S05 M05B4	102	F 203_156.3 P63 BN63B4	103
8.5	189	2.1	155.9	6500	F 253_155.9 S05 M05B4	106	F 253_155.9 P63 BN63B4	107
8.8	183	3.3	150.8	6500			F 313_150.8 P63 BN63B4	111
9.2	173	2.3	143.0	6500	F 253_143.0 S05 M05B4	106	F 253_143.0 P63 BN63B4	107
9.4	171	3.5	140.7	6500			F 313_140.7 P63 BN63B4	111
10.0	164	1.5	132.2	4000	F 202_132.2 S05 M05B4	102	F 202_132.2 P63 BN63B4	103
10.3	155	2.6	127.8	6500	F 253_127.8 S05 M05B4	106	F 253_127.8 P63 BN63B4	107
10.4	157	0.9	127.1	2800	F 102_127.1 S05 M05B4	98	F 102_127.1 P63 BN63B4	99
11.5	142	1.8	114.3	4000	F 202_114.3 S05 M05B4	102	F 202_114.3 P63 BN63B4	103
11.7	137	2.9	113.0	6500	F 253_113.0 S05 M05B4	106	F 253_113.0 P63 BN63B4	107
12.5	131	1.1	106.0	2800	F 102_106.0 S05 M05B4	98	F 102_106.0 P63 BN63B4	99
12.5	128	3.1	105.4	6500	F 253_105.4 S05 M05B4	106	F 253_105.4 P63 BN63B4	107
13.0	126	2.0	101.6	4000	F 202_101.6 S05 M05B4	102	F 202_101.6 P63 BN63B4	103
13.8	116	3.5	95.5	6500	F 253_95.5 S05 M05B4	106	F 253_95.5 P63 BN63B4	107
14.4	113	1.2	91.5	2800	F 102_91.5 S05 M05B4	98	F 102_91.5 P63 BN63B4	99
14.6	112	2.2	90.4	4000	F 202_90.4 S05 M05B4	102	F 202_90.4 P63 BN63B4	103
16.2	101	1.4	81.3	2800	F 102_81.3 S05 M05B4	98	F 102_81.3 P63 BN63B4	99
17.2	95	2.6	76.8	4000	F 202_76.8 S05 M05B4	102	F 202_76.8 P63 BN63B4	103
18.6	88	1.6	71.1	2800	F 102_71.1 S05 M05B4	98	F 102_71.1 P63 BN63B4	99
19.1	86	2.9	69.1	4000	F 202_69.1 S05 M05B4	102	F 202_69.1 P63 BN63B4	103
21.0	78	1.8	63.0	2800	F 102_63.0 S05 M05B4	98	F 102_63.0 P63 BN63B4	99
21.3	77	3.3	61.9	4000	F 202_61.9 S05 M05B4	102	F 202_61.9 P63 BN63B4	103
23.3	70	2.0	56.7	2800	F 102_56.7 S05 M05B4	98	F 102_56.7 P63 BN63B4	99
27.1	60	2.3	48.7	2800	F 102_48.7 S05 M05B4	98	F 102_48.7 P63 BN63B4	99

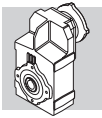

0.18 кВт

n_2 мин ⁻¹	M_2 Нм	S	i	R_{n2} Н				
29.6	55	2.5	44.7	2800	F 102_44.7 S05 M05B4	98	F 102_44.7 P63 BN63B4	99
33	49	2.9	39.6	2800	F 102_39.6 S05 M05B4	98	F 102_39.6 P63 BN63B4	99
37	44	3.2	35.3	2800	F 102_35.3 S05 M05B4	98	F 102_35.3 P63 BN63B4	99
40	41	3.4	33.0	2800	F 102_33.0 S05 M05B4	98	F 102_33.0 P63 BN63B4	99
45	37	3.8	29.6	2800	F 102_29.6 S05 M05B4	98	F 102_29.6 P63 BN63B4	99
51	32	4.4	25.8	2780	F 102_25.8 S05 M05B4	98	F 102_25.8 P63 BN63B4	99
58	28	5.0	22.8	2680	F 102_22.8 S05 M05B4	98	F 102_22.8 P63 BN63B4	99
68	24	5.7	19.3	2540	F 102_19.3 S05 M05B4	98	F 102_19.3 P63 BN63B4	99
78	21	6.1	17.0	2440	F 102_17.0 S05 M05B4	98	F 102_17.0 P63 BN63B4	99
90	18	6.6	14.6	2330	F 102_14.6 S05 M05B4	98	F 102_14.6 P63 BN63B4	99
101	16	6.4	13.0	2240	F 102_13.0 S05 M05B4	98	F 102_13.0 P63 BN63B4	99
114	14	6.7	11.5	2150	F 102_11.5 S05 M05B4	98	F 102_11.5 P63 BN63B4	99
135	12	7.4	9.8	2040	F 102_9.8 S05 M05B4	98	F 102_9.8 P63 BN63B4	99
154	11	7.7	8.6	1960	F 102_8.6 S05 M05B4	98	F 102_8.6 P63 BN63B4	99
178	9	8.3	7.4	1870	F 102_7.4 S05 M05B4	98	F 102_7.4 P63 BN63B4	99
186	9	10.7	14.6	1860	F 102_14.6 S05 M05A2	98	F 102_14.6 P63 BN63A2	99
210	8	10.9	13.0	1790	F 102_13.0 S05 M05A2	98	F 102_13.0 P63 BN63A2	99
237	7	11.3	11.5	1720	F 102_11.5 S05 M05A2	98	F 102_11.5 P63 BN63A2	99
279	6	12.5	9.8	1630	F 102_9.8 S05 M05A2	98	F 102_9.8 P63 BN63A2	99
318	5	13.0	8.6	1560	F 102_8.6 S05 M05A2	98	F 102_8.6 P63 BN63A2	99
369	4	14.2	7.4	1490	F 102_7.4 S05 M05A2	98	F 102_7.4 P63 BN63A2	99

0.25 кВт

n_2 мин ⁻¹	M_2 Нм	S	i	R_{n2} Н				
0.41	5283	0.9	2188	35000	F 704_2188 S1 M1SD6	126	F 704_2188 P71 BN71B6	127
0.45	4877	1.0	2019	35000	F 704_2019 S1 M1SD6	126	F 704_2019 P71 BN71B6	127
0.45	4799	1.7	1987	45000	F 804_1987 S1 M1SD6	129	F 804_1987 P71 BN71B6	130
0.49	4430	1.8	1834	45000	F 804_1834 S1 M1SD6	129	F 804_1834 P71 BN71B6	130
0.52	4146	1.2	1717	35000	F 704_1717 S1 M1SD6	126	F 704_1717 P71 BN71B6	127
0.53	4128	1.9	1709	45000	F 804_1709 S1 M1SD6	129	F 804_1709 P71 BN71B6	130
0.57	3827	1.3	1585	35000	F 704_1585 S1 M1SD6	126	F 704_1585 P71 BN71B6	127
0.57	3810	2.1	1578	45000	F 804_1578 S1 M1SD6	129	F 804_1578 P71 BN71B6	130
0.61	3578	1.4	1481	35000	F 704_1481 S1 M1SD6	126	F 704_1481 P71 BN71B6	127
0.65	3342	2.4	1384	45000	F 804_1384 S1 M1SD6	129	F 804_1384 P71 BN71B6	130
0.66	3303	1.5	1368	35000	F 704_1368 S1 M1SD6	126	F 704_1368 P71 BN71B6	127
0.70	3085	2.6	1277	45000	F 804_1277 S1 M1SD6	129	F 804_1277 P71 BN71B6	130
0.76	2854	1.8	1182	35000	F 704_1182 S1 M1SD6	126	F 704_1182 P71 BN71B6	127
0.79	2757	1.1	1141	20000	F 604_1141 S1 M1SD6	122	F 604_1141 P71 BN71B6	123
0.79	2769	2.9	1146	45000	F 804_1146 S1 M1SD6	129	F 804_1146 P71 BN71B6	130
0.83	2635	1.9	1091	35000	F 704_1091 S1 M1SD6	126	F 704_1091 P71 BN71B6	127
0.85	2545	1.1	1054	20000	F 604_1054 S1 M1SD6	122	F 604_1054 P71 BN71B6	123
0.85	2556	3.1	1058	45000	F 804_1058 S1 M1SD6	129	F 804_1058 P71 BN71B6	130
0.92	2353	2.1	974.4	35000	F 704_974.4 S1 M1SD6	126	F 704_974.4 P71 BN71B6	127
0.94	2316	1.3	958.9	20000	F 604_958.9 S1 M1SD6	122	F 604_958.9 P71 BN71B6	123
1.0	2138	1.4	885.1	20000	F 604_885.1 S1 M1SD6	122	F 604_885.1 P71 BN71B6	123
1.0	2172	2.3	899.4	35000	F 704_899.4 S1 M1SD6	126	F 704_899.4 P71 BN71B6	127
1.1	1996	0.9	826.4	12000	F 514_826.4 S1 M1SD6	118	F 514_826.4 P71 BN71B6	119
1.1	1986	2.5	822.2	35000	F 704_822.2 S1 M1SD6	126	F 704_822.2 P71 BN71B6	127
1.3	1633	1.1	676.3	12000	F 514_676.3 S1 M1SD6	118	F 514_676.3 P71 BN71B6	119
1.4	1600	1.8	662.4	20000	F 604_662.4 S1 M1SD6	122	F 604_662.4 P71 BN71B6	123
1.4	1588	3.1	657.4	35000	F 704_657.4 S1 M1SD6	126	F 704_657.4 P71 BN71B6	127
1.5	1477	2.0	611.4	20000	F 604_611.4 S1 M1SD6	122	F 604_611.4 P71 BN71B6	123
1.5	1466	3.4	606.8	35000	F 704_606.8 S1 M1SD6	126	F 704_606.8 P71 BN71B6	127
1.7	1282	0.9	813.8	8500	F 414_813.8 S05 M05C4	114	F 414_813.8 P71 BN71A4	115
1.8	1199	0.9	739.4	8500	F 414_739.4 S05 M05C4	114	F 414_739.4 P71 BN71A4	115
1.9	1119	1.0	690.1	8500	F 414_690.1 S05 M05C4	114	F 414_690.1 P71 BN71A4	115

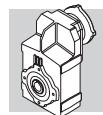

0.25 КВТ

n ₂ МИН-1	M ₂ Нм	S	i	R _{n2} Н			IEC	
2.4	892	1.2	549.8	8500	F 414_549.8 S05 M05C4	114	F 414_549.8 P71 BN71A4	115
2.8	783	2.3	317.3	12000	F 513_317.3 S1 M1SD6	118	F 513_317.3 P71 BN71B6	119
3.1	704	1.6	433.7	8500	F 414_433.7 S05 M05C4	114	F 414_433.7 P71 BN71A4	115
3.2	679	0.9	418.9	6500	F 314_418.9 S05 M05C4	110	F 314_418.9 P71 BN71A4	111
3.7	603	1.0	374.4	6500			F 313_374.4 P71 BN71A4	111
4.0	555	2.0	344.8	8500			F 413_344.8 P71 BN71A4	115
4.1	536	1.1	332.8	6500			F 313_332.8 P71 BN71A4	111
4.7	473	1.3	293.8	6500			F 313_293.8 P71 BN71A4	111
4.7	477	2.3	296.6	8500			F 413_296.6 P71 BN71A4	115
5.2	425	0.9	256.1	6500	F 253_256.1 S05 M05C4	106	F 253_256.1 P71 BN71A4	107
5.2	430	2.6	266.9	8500			F 413_266.9 P71 BN71A4	115
5.4	408	1.5	253.6	6500			F 313_253.6 P71 BN71A4	111
5.7	387	2.8	240.1	8500			F 413_240.1 P71 BN71A4	115
5.9	378	1.1	227.8	6500	F 253_227.8 S05 M05C4	106	F 253_227.8 P71 BN71A4	107
6.0	367	1.6	228.2	6500			F 313_228.2 P71 BN71A4	111
6.3	354	3.1	220.1	8500			F 413_220.1 P71 BN71A4	115
6.8	326	1.8	202.3	6500			F 313_202.3 P71 BN71A4	111
6.9	321	1.2	193.6	6500	F 253_193.6 S05 M05C4	106	F 253_193.6 P71 BN71A4	107
6.9	320	3.4	198.9	8500			F 413_198.9 P71 BN71A4	115
7.4	299	2.0	185.4	6500			F 313_185.4 P71 BN71A4	111
7.7	289	1.4	174.2	6500	F 253_174.2 S05 M05C4	106	F 253_174.2 P71 BN71A4	107
8.0	278	0.9	172.6	4000	F 203_172.6 S05 M05C4	102	F 203_172.6 P71 BN71A4	103
8.3	268	2.2	166.8	6500			F 313_166.8 P71 BN71A4	111
8.6	259	1.0	156.3	4000	F 203_156.3 S05 M05C4	102	F 203_156.3 P71 BN71A4	103
8.6	259	1.5	155.9	6500	F 253_155.9 S05 M05C4	106	F 253_155.9 P71 BN71A4	107
9.2	243	2.5	150.8	6500			F 313_150.8 P71 BN71A4	111
9.7	230	1.7	143.0	6500	F 253_143.0 S05 M05C4	106	F 253_143.0 P71 BN71A4	107
9.8	227	2.6	140.7	6500			F 313_140.7 P71 BN71A4	111
10.1	224	1.1	132.2	4000	F 202_132.2 S05 M05C4	102	F 202_132.2 P71 BN71A4	103
10.5	212	1.9	127.8	6500	F 253_127.8 S05 M05C4	106	F 253_127.8 P71 BN71A4	107
10.7	207	2.9	128.4	6500			F 313_128.4 P71 BN71A4	111
11.7	194	1.3	114.3	4000	F 202_114.3 S05 M05C4	102	F 202_114.3 P71 BN71A4	103
12.2	182	2.2	113.0	6500	F 253_113.0 S05 M05C4	106	F 253_113.0 P71 BN71A4	107
12.3	181	3.3	112.5	6500			F 313_112.5 P71 BN71A4	111
12.7	175	2.3	105.4	6500	F 253_105.4 S05 M05C4	106	F 253_105.4 P71 BN71A4	107
13.2	172	1.5	101.6	4000	F 202_101.6 S05 M05C4	102	F 202_101.6 P71 BN71A4	103
14.0	158	2.5	95.5	6500	F 253_95.5 S05 M05C4	106	F 253_95.5 P71 BN71A4	107
14.6	155	0.9	91.5	2800	F 102_91.5 S05 M05C4	98	F 102_91.5 P71 BN71A4	99
14.8	153	1.6	90.4	4000	F 202_90.4 S05 M05C4	102	F 202_90.4 P71 BN71A4	103
16.1	138	2.9	83.4	6500	F 253_83.4 S05 M05C4	106	F 253_83.4 P71 BN71A4	107
16.5	138	1.0	81.3	2800	F 102_81.3 S05 M05C4	98	F 102_81.3 P71 BN71A4	99
17.4	130	1.9	76.8	4000	F 202_76.8 S05 M05C4	102	F 202_76.8 P71 BN71A4	103
17.5	127	3.2	76.6	6420	F 253_76.6 S05 M05C4	106	F 253_76.6 P71 BN71A4	107
18.8	120	1.2	71.1	2800	F 102_71.1 S05 M05C4	98	F 102_71.1 P71 BN71A4	99
19.4	117	2.1	69.1	4000	F 202_69.1 S05 M05C4	102	F 202_69.1 P71 BN71A4	103
21.3	107	1.3	63.0	2800	F 102_63.0 S05 M05C4	98	F 102_63.0 P71 BN71A4	99
21.7	105	2.4	61.9	4000	F 202_61.9 S05 M05C4	102	F 202_61.9 P71 BN71A4	103
23.6	96	1.5	56.7	2800	F 102_56.7 S05 M05C4	98	F 102_56.7 P71 BN71A4	99
23.6	96	2.6	56.7	4000	F 202_56.7 S05 M05C4	102	F 202_56.7 P71 BN71A4	103
26.4	86	2.9	50.7	4000	F 202_50.7 S05 M05C4	102	F 202_50.7 P71 BN71A4	103
27.5	83	1.7	48.7	2800	F 102_48.7 S05 M05C4	98	F 102_48.7 P71 BN71A4	99
29.9	76	3.3	44.8	3870	F 202_44.8 S05 M05C4	102	F 202_44.8 P71 BN71A4	103
30	76	1.9	44.7	2800	F 102_44.7 S05 M05C4	98	F 102_44.7 P71 BN71A4	99
34	67	2.1	39.6	2800	F 102_39.6 S05 M05C4	98	F 102_39.6 P71 BN71A4	99
38	60	2.3	35.3	2800	F 102_35.3 S05 M05C4	98	F 102_35.3 P71 BN71A4	99
41	56	2.5	33.0	2800	F 102_33.0 S05 M05C4	98	F 102_33.0 P71 BN71A4	99
45	50	2.8	29.6	2800	F 102_29.6 S05 M05C4	98	F 102_29.6 P71 BN71A4	99
52	44	3.2	25.8	2750	F 102_25.8 S05 M05C4	98	F 102_25.8 P71 BN71A4	99
59	39	3.6	22.8	2650	F 102_22.8 S05 M05C4	98	F 102_22.8 P71 BN71A4	99
69	33	4.2	19.3	2520	F 102_19.3 S05 M05C4	98	F 102_19.3 P71 BN71A4	99
81	28	4.6	17.0	2420	F 102_17.0 S05 M05C4	98	F 102_17.0 P71 BN71A4	99

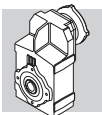

0.25 КВТ



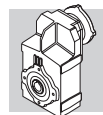

n₂ МИН-1	M₂ Нм	S	i	R_{n2} Н					
91	25	4.8	14.6	2310	F 102_14.6 S05 M05C4	98	F 102_14.6 P71	BN71A4	99
103	22	4.7	13.0	2230	F 102_13.0 S05 M05C4	98	F 102_13.0 P71	BN71A4	99
120	19	5.1	11.5	2140	F 102_11.5 S05 M05C4	98	F 102_11.5 P71	BN71A4	99
137	17	5.4	9.8	2030	F 102_9.8 S05 M05C4	98	F 102_9.8 P71	BN71A4	99
161	14	5.8	8.6	1950	F 102_8.6 S05 M05C4	98	F 102_8.6 P71	BN71A4	99
181	13	6.1	7.4	1860	F 102_7.4 S05 M05C4	98	F 102_7.4 P71	BN71A4	99
187	12	7.7	14.6	1850	F 102_14.6 S05 M05B2	98	F 102_14.6 P63	BN63B2	99
210	11	7.9	13.0	1780	F 102_13.0 S05 M05B2	98	F 102_13.0 P63	BN63B2	99
237	10	8.2	11.5	1710	F 102_11.5 S05 M05B2	98	F 102_11.5 P63	BN63B2	99
280	8	9.0	9.8	1620	F 102_9.8 S05 M05B2	98	F 102_9.8 P63	BN63B2	99
319	7	9.4	8.6	1550	F 102_8.6 S05 M05B2	98	F 102_8.6 P63	BN63B2	99
370	6	10.3	7.4	1480	F 102_7.4 S05 M05B2	98	F 102_7.4 P63	BN63B2	99

0.37 КВТ

n₂ МИН-1	M₂ Нм	S	i	R_{n2} Н					
0.46	7024	1.1	1987	45000	F 804_1987 S1 M1LA6	129	F 804_1987 P80	BN80A6	130
0.50	6484	1.2	1834	45000	F 804_1834 S1 M1LA6	129	F 804_1834 P80	BN80A6	130
0.53	6042	1.3	1709	45000	F 804_1709 S1 M1LA6	129	F 804_1709 P80	BN80A6	130
0.57	5602	0.9	1585	35000	F 704_1585 S1 M1LA6	126	F 704_1585 P80	BN80A6	127
0.58	5577	1.4	1578	45000	F 804_1578 S1 M1LA6	129	F 804_1578 P80	BN80A6	130
0.61	5238	1.0	1481	35000	F 704_1481 S1 M1LA6	126	F 704_1481 P80	BN80A6	127
0.63	5137	1.0	2188	35000	F 704_2188 S1 M1SD4	126	F 704_2188 P71	BN71B4	127
0.68	4742	1.1	2019	35000	F 704_2019 S1 M1SD4	126	F 704_2019 P71	BN71B4	127
0.69	4666	1.7	1987	45000	F 804_1987 S1 M1SD4	129	F 804_1987 P71	BN71B4	130
0.75	4307	1.9	1834	45000	F 804_1834 S1 M1SD4	129	F 804_1834 P71	BN71B4	130
0.80	4031	1.2	1717	35000	F 704_1717 S1 M1SD4	126	F 704_1717 P71	BN71B4	127
0.80	4013	2.0	1709	45000	F 804_1709 S1 M1SD4	129	F 804_1709 P71	BN71B4	130
0.86	3721	1.3	1585	35000	F 704_1585 S1 M1SD4	126	F 704_1585 P71	BN71B4	127
0.87	3705	2.2	1578	45000	F 804_1578 S1 M1SD4	129	F 804_1578 P71	BN71B4	130
0.92	3479	1.4	1481	35000	F 704_1481 S1 M1SD4	126	F 704_1481 P71	BN71B4	127
0.99	3250	2.5	1384	45000	F 804_1384 S1 M1SD4	129	F 804_1384 P71	BN71B4	130
1.0	3211	1.6	1368	35000	F 704_1368 S1 M1SD4	126	F 704_1368 P71	BN71B4	127
1.1	3000	2.7	1277	45000	F 804_1277 S1 M1SD4	129	F 804_1277 P71	BN71B4	130
1.2	2680	1.1	1141	20000	F 604_1141 S1 M1SD4	122	F 604_1141 P71	BN71B4	123
1.2	2775	1.8	1182	35000	F 704_1182 S1 M1SD4	126	F 704_1182 P71	BN71B4	127
1.2	2692	3.0	1146	45000	F 804_1146 S1 M1SD4	129	F 804_1146 P71	BN71B4	130
1.3	2474	1.2	1054	20000	F 604_1054 S1 M1SD4	122	F 604_1054 P71	BN71B4	123
1.3	2562	2.0	1091	35000	F 704_1091 S1 M1SD4	126	F 704_1091 P71	BN71B4	127
1.3	2485	3.2	1058	45000	F 804_1058 S1 M1SD4	129	F 804_1058 P71	BN71B4	130
1.4	2252	1.3	958.9	20000	F 604_958.9 S1 M1SD4	122	F 604_958.9 P71	BN71B4	123
1.4	2288	2.2	974.4	35000	F 704_974.4 S1 M1SD4	126	F 704_974.4 P71	BN71B4	127
1.5	2079	0.9	885.5	12000	F 514_885.5 S1 M1SD4	118	F 514_885.5 P71	BN71B4	119
1.5	2078	1.4	885.1	20000	F 604_885.1 S1 M1SD4	122	F 604_885.1 P71	BN71B4	123
1.5	2112	2.4	899.4	35000	F 704_899.4 S1 M1SD4	126	F 704_899.4 P71	BN71B4	127
1.7	1941	0.9	826.4	12000	F 514_826.4 S1 M1SD4	118	F 514_826.4 P71	BN71B4	119
1.7	1931	2.6	822.2	35000	F 704_822.2 S1 M1SD4	126	F 704_822.2 P71	BN71B4	127
2.0	1588	1.1	676.3	12000	F 514_676.3 S1 M1SD4	118	F 514_676.3 P71	BN71B4	119
2.1	1556	1.9	662.4	20000	F 604_662.4 S1 M1SD4	122	F 604_662.4 P71	BN71B4	123
2.1	1544	3.2	657.4	35000	F 704_657.4 S1 M1SD4	126	F 704_657.4 P71	BN71B4	127
2.2	1436	2.0	611.4	20000	F 604_611.4 S1 M1SD4	122	F 604_611.4 P71	BN71B4	123
2.3	1425	3.5	606.8	35000	F 704_606.8 S1 M1SD4	126	F 704_606.8 P71	BN71B4	127
2.5	1291	0.9	549.8	8500	F 414_549.8 S1 M1SD4	114	F 414_549.8 P71	BN71B4	115
2.6	1246	1.4	530.5	12000	F 514_530.5 S1 M1SD4	118	F 514_530.5 P71	BN71B4	119
2.6	1246	2.3	530.7	20000	F 604_530.7 S1 M1SD4	122	F 604_530.7 P71	BN71B4	123
2.8	1150	2.5	489.8	20000	F 604_489.8 S1 M1SD4	122	F 604_489.8 P71	BN71B4	123

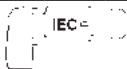

0.37 кВт

n ₂ МИН-1	M ₂ Нм	S	i	R _{n2} Н				
3.2	1018	1.1	433.7	8500	F 414_433.7 S1 M1SD4	114	F 414_433.7 P71 BN71B4	115
3.2	1008	1.8	429.1	12000	F 514_429.1 S1 M1SD4	118	F 514_429.1 P71 BN71B4	119
3.2	1016	2.9	432.6	20000	F 604_432.6 S1 M1SD4	122	F 604_432.6 P71 BN71B4	123
3.4	938	3.1	399.3	20000	F 604_399.3 S1 M1SD4	122	F 604_399.3 P71 BN71B4	123
3.9	846	2.1	352.5	12000	F 513_352.5 S1 M1SD4	118	F 513_352.5 P71 BN71B4	119
4.0	827	1.3	344.8	8500	F 413_344.8 S1 M1SD4	114	F 413_344.8 P71 BN71B4	115
4.3	761	2.4	317.3	12000	F 513_317.3 S1 M1SD4	118	F 513_317.3 P71 BN71B4	119
4.6	712	1.5	296.6	8500	F 413_296.6 S1 M1SD4	114	F 413_296.6 P71 BN71B4	115
4.8	686	2.6	285.9	12000	F 513_285.9 S1 M1SD4	118	F 513_285.9 P71 BN71B4	119
5.1	641	1.7	266.9	8500	F 413_266.9 S1 M1SD4	114	F 413_266.9 P71 BN71B4	115
5.2	629	2.9	262.1	12000	F 513_262.1 S1 M1SD4	118	F 513_262.1 P71 BN71B4	119
5.4	609	1.0	253.6	6500	F 313_253.6 S1 M1SD4	110	F 313_253.6 P71 BN71B4	111
5.7	576	1.9	240.1	8500	F 413_240.1 S1 M1SD4	114	F 413_240.1 P71 BN71B4	115
5.7	576	3.1	239.8	12000	F 513_239.8 S1 M1SD4	118	F 513_239.8 P71 BN71B4	119
6.0	548	1.1	228.2	6500	F 313_228.2 S1 M1SD4	110	F 313_228.2 P71 BN71B4	111
6.2	528	2.1	220.1	8500	F 413_220.1 S1 M1SD4	114	F 413_220.1 P71 BN71B4	115
6.3	520	3.5	216.9	12000	F 513_216.9 S1 M1SD4	118	F 513_216.9 P71 BN71B4	119
6.8	485	1.2	202.3	6500	F 313_202.3 S1 M1SD4	110	F 313_202.3 P71 BN71B4	111
6.9	477	2.3	198.9	8500	F 413_198.9 S1 M1SD4	114	F 413_198.9 P71 BN71B4	115
7.4	445	1.3	185.4	6500	F 313_185.4 S1 M1SD4	110	F 313_185.4 P71 BN71B4	111
7.6	434	2.5	180.7	8500	F 413_180.7 S1 M1SD4	114	F 413_180.7 P71 BN71B4	115
7.9	418	1.0	174.2	6500	F 253_174.2 S1 M1SD4	106	F 253_174.2 P71 BN71B4	107
8.1	405	2.7	168.7	8500	F 413_168.7 S1 M1SD4	114	F 413_168.7 P71 BN71B4	115
8.2	400	1.5	166.8	6500	F 313_166.8 S1 M1SD4	110	F 313_166.8 P71 BN71B4	111
8.8	374	1.1	155.9	6500	F 253_155.9 S1 M1SD4	106	F 253_155.9 P71 BN71B4	107
9.1	362	1.7	150.8	6500	F 313_150.8 S1 M1SD4	110	F 313_150.8 P71 BN71B4	111
9.6	343	1.2	143.0	6500	F 253_143.0 S1 M1SD4	106	F 253_143.0 P71 BN71B4	107
9.7	338	1.8	140.7	6500	F 313_140.7 S1 M1SD4	110	F 313_140.7 P71 BN71B4	111
10.2	323	3.4	134.4	8500	F 413_134.4 S1 M1SD4	114	F 413_134.4 P71 BN71B4	115
10.7	307	1.3	127.8	6500	F 253_127.8 S1 M1SD4	106	F 253_127.8 P71 BN71B4	107
10.7	308	1.9	128.4	6500	F 313_128.4 S1 M1SD4	110	F 313_128.4 P71 BN71B4	111
12.1	271	1.5	113.0	6500	F 253_113.0 S1 M1SD4	106	F 253_113.0 P71 BN71B4	107
12.2	270	2.2	112.5	6500	F 313_112.5 S1 M1SD4	110	F 313_112.5 P71 BN71B4	111
13.0	253	1.6	105.4	6500	F 253_105.4 S1 M1SD4	106	F 253_105.4 P71 BN71B4	107
13.4	245	2.5	101.9	6500	F 313_101.9 S1 M1SD4	110	F 313_101.9 P71 BN71B4	111
13.5	249	1.0	101.6	4000	F 202_101.6 S1 M1SD4	102	F 202_101.6 P71 BN71B4	103
14.3	229	1.7	95.5	6490	F 253_95.5 S1 M1SD4	106	F 253_95.5 P71 BN71B4	107
15.2	222	1.1	90.4	4000	F 202_90.4 S1 M1SD4	102	F 202_90.4 P71 BN71B4	103
15.7	210	2.9	87.4	6500	F 313_87.4 S1 M1SD4	110	F 313_87.4 P71 BN71B4	111
16.4	200	2.0	83.4	6280	F 253_83.4 S1 M1SD4	106	F 253_83.4 P71 BN71B4	107
17.4	189	3.2	78.9	6500	F 313_78.9 S1 M1SD4	110	F 313_78.9 P71 BN71B4	111
17.8	188	1.3	76.8	4000	F 202_76.8 S1 M1SD4	102	F 202_76.8 P71 BN71B4	103
17.9	184	2.2	76.6	6160	F 253_76.6 S1 M1SD4	106	F 253_76.6 P71 BN71B4	107
19.8	169	1.5	69.1	4000	F 202_69.1 S1 M1SD4	102	F 202_69.1 P71 BN71B4	103
21.0	157	2.6	65.3	5920	F 253_65.3 S1 M1SD4	106	F 253_65.3 P71 BN71B4	107
21.7	154	0.9	63.0	2800	F 102_63.0 S1 M1SD4	98	F 102_63.0 P71 BN71B4	99
22.1	152	1.6	61.9	4000	F 202_61.9 S1 M1SD4	102	F 202_61.9 P71 BN71B4	103
23.5	140	2.9	58.3	5750	F 253_58.3 S1 M1SD4	106	F 253_58.3 P71 BN71B4	107
24.2	139	1.0	56.7	2800	F 102_56.7 S1 M1SD4	98	F 102_56.7 P71 BN71B4	99
24.2	139	1.8	56.7	4000	F 202_56.7 S1 M1SD4	102	F 202_56.7 P71 BN71B4	103
27.0	124	2.0	50.7	3900	F 202_50.7 S1 M1SD4	102	F 202_50.7 P71 BN71B4	103
27.0	122	3.3	50.8	5540	F 253_50.8 S1 M1SD4	106	F 253_50.8 P71 BN71B4	107
28.1	119	1.2	48.7	2800	F 102_48.7 S1 M1SD4	98	F 102_48.7 P71 BN71B4	99
31	110	1.3	44.7	2800	F 102_44.7 S1 M1SD4	98	F 102_44.7 P71 BN71B4	99
31	110	2.3	44.8	3770	F 202_44.8 S1 M1SD4	102	F 202_44.8 P71 BN71B4	103
31	109	3.5	44.4	5370	F 252_44.4 S1 M1SD4	106	F 252_44.4 P71 BN71B4	107
33	103	2.4	41.8	3700	F 202_41.8 S1 M1SD4	102	F 202_41.8 P71 BN71B4	103
35	97	1.4	39.6	2800	F 102_39.6 S1 M1SD4	98	F 102_39.6 P71 BN71B4	99
36	93	2.7	37.9	3600	F 202_37.9 S1 M1SD4	102	F 202_37.9 P71 BN71B4	103
39	87	1.6	35.3	2800	F 102_35.3 S1 M1SD4	98	F 102_35.3 P71 BN71B4	99
41	81	3.1	33.1	3460	F 202_33.1 S1 M1SD4	102	F 202_33.1 P71 BN71B4	103

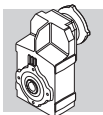

0.37 кВт



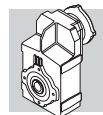

n ₂ мин-1	M ₂ Нм	S	i	R _{n2} Н					
42	81	1.7	33.0	2800	F 102_33.0 S1 M1SD4	98	F 102_33.0 P71	BN71B4	99
45	75	3.4	30.4	3380	F 202_30.4 S1 M1SD4	102	F 202_30.4 P71	BN71B4	103
46	73	1.9	29.6	2800	F 102_29.6 S1 M1SD4	98	F 102_29.6 P71	BN71B4	99
53	63	2.2	25.8	2690	F 102_25.8 S1 M1SD4	98	F 102_25.8 P71	BN71B4	99
60	56	2.5	22.8	2600	F 102_22.8 S1 M1SD4	98	F 102_22.8 P71	BN71B4	99
71	47	2.9	19.3	2470	F 102_19.3 S1 M1SD4	98	F 102_19.3 P71	BN71B4	99
81	42	3.1	17.0	2380	F 102_17.0 S1 M1SD4	98	F 102_17.0 P71	BN71B4	99
94	36	3.3	14.6	2280	F 102_14.6 S1 M1SD4	98	F 102_14.6 P71	BN71B4	99
105	32	3.3	13.0	2200	F 102_13.0 S1 M1SD4	98	F 102_13.0 P71	BN71B4	99
119	28	3.4	11.5	2120	F 102_11.5 S1 M1SD4	98	F 102_11.5 P71	BN71B4	99
140	24	3.7	9.8	2010	F 102_9.8 S1 M1SD4	98	F 102_9.8 P71	BN71B4	99
160	21	3.9	8.6	1930	F 102_8.6 S1 M1SD4	98	F 102_8.6 P71	BN71B4	99
185	18	4.2	7.4	1850	F 102_7.4 S1 M1SD4	98	F 102_7.4 P71	BN71B4	99
193	17	5.4	14.6	1830	F 102_14.6 S05 M05C2	98	F 102_14.6 P71	BN71A2	99
216	16	5.5	13.0	1760	F 102_13.0 S05 M05C2	98	F 102_13.0 P71	BN71A2	99
244	14	5.7	11.5	1690	F 102_11.5 S05 M05C2	98	F 102_11.5 P71	BN71A2	99
289	12	6.3	9.8	1610	F 102_9.8 S05 M05C2	98	F 102_9.8 P71	BN71A2	99
329	10	6.6	8.6	1540	F 102_8.6 S05 M05C2	98	F 102_8.6 P71	BN71A2	99
381	9	7.1	7.4	1470	F 102_7.4 S05 M05C2	98	F 102_7.4 P71	BN71A2	99

0.55 кВт

n ₂ мин-1	M ₂ Нм	S	i	R _{n2} Н					
0.44	10909	1.3	2099	55000	F 904_2099 S2 M2SA6	132	F 904_2099 P80	BN80B6	133
0.47	10070	1.4	1937	55000	F 904_1937 S2 M2SA6	132	F 904_1937 P80	BN80B6	133
0.54	8884	0.9	1709	45000	F 804_1709 S2 M2SA6	129	F 804_1709 P80	BN80B6	130
0.54	8849	1.6	1702	55000	F 904_1702 S2 M2SA6	132	F 904_1702 P80	BN80B6	133
0.58	8201	1.0	1578	45000	F 804_1578 S2 M2SA6	129	F 804_1578 P80	BN80B6	130
0.59	8168	1.7	1571	55000	F 904_1571 S2 M2SA6	132	F 904_1571 P80	BN80B6	133
0.64	7422	1.9	1428	55000	F 904_1428 S2 M2SA6	132	F 904_1428 P80	BN80B6	133
0.66	7193	1.1	1384	45000	F 804_1384 S2 M2SA6	129	F 804_1384 P80	BN80B6	130
0.69	6885	1.2	1987	45000	F 804_1987 S1 M1LA4	129	F 804_1987 P80	BN80A4	130
0.75	6356	1.3	1834	45000	F 804_1834 S1 M1LA4	129	F 804_1834 P80	BN80A4	130
0.81	5923	1.4	1709	45000	F 804_1709 S1 M1LA4	129	F 804_1709 P80	BN80A4	130
0.87	5491	0.9	1585	35000	F 704_1585 S1 M1LA4	126	F 704_1585 P80	BN80A4	127
0.87	5467	1.5	1578	45000	F 804_1578 S1 M1LA4	129	F 804_1578 P80	BN80A4	130
0.93	5134	1.0	1481	35000	F 704_1481 S1 M1LA4	126	F 704_1481 P80	BN80A4	127
1.0	4739	1.1	1368	35000	F 704_1368 S1 M1LA4	126	F 704_1368 P80	BN80A4	127
1.0	4795	1.7	1384	45000	F 804_1384 S1 M1LA4	129	F 804_1384 P80	BN80A4	130
1.1	4427	1.8	1277	45000	F 804_1277 S1 M1LA4	129	F 804_1277 P80	BN80A4	130
1.2	4095	1.2	1182	35000	F 704_1182 S1 M1LA4	126	F 704_1182 P80	BN80A4	127
1.2	3972	2.0	1146	45000	F 804_1146 S1 M1LA4	129	F 804_1146 P80	BN80A4	130
1.3	3780	1.3	1091	35000	F 704_1091 S1 M1LA4	126	F 704_1091 P80	BN80A4	127
1.3	3667	2.2	1058	45000	F 804_1058 S1 M1LA4	129	F 804_1058 P80	BN80A4	130
1.4	3323	0.9	958.9	20000	F 604_958.9 S1 M1LA4	122	F 604_958.9 P80	BN80A4	123
1.4	3377	1.5	974.4	35000	F 704_974.4 S1 M1LA4	126	F 704_974.4 P80	BN80A4	127
1.5	3117	1.6	899.4	35000	F 704_899.4 S1 M1LA4	126	F 704_899.4 P80	BN80A4	127
1.5	3109	2.6	897.3	45000	F 804_897.3 S1 M1LA4	129	F 804_897.3 P80	BN80A4	130
1.6	3067	0.9	885.1	20000	F 604_885.1 S1 M1LA4	122	F 604_885.1 P80	BN80A4	123
1.7	2849	1.8	822.2	35000	F 704_822.2 S1 M1LA4	126	F 704_822.2 P80	BN80A4	127
1.8	2684	3.0	774.4	45000	F 804_774.4 S1 M1LA4	129	F 804_774.4 P80	BN80A4	130
1.9	2477	3.2	714.9	45000	F 804_714.9 S1 M1LA4	129	F 804_714.9 P80	BN80A4	130
2.1	2295	1.3	662.4	20000	F 604_662.4 S1 M1LA4	122	F 604_662.4 P80	BN80A4	123
2.1	2278	2.2	657.4	35000	F 704_657.4 S1 M1LA4	126	F 704_657.4 P80	BN80A4	127
2.3	2119	1.4	611.4	20000	F 604_611.4 S1 M1LA4	122	F 604_611.4 P80	BN80A4	123
2.3	2103	2.4	606.8	35000	F 704_606.8 S1 M1LA4	126	F 704_606.8 P80	BN80A4	127
2.6	1838	1.0	530.5	12000	F 514_530.5 S1 M1LA4	118	F 514_530.5 P80	BN80A4	119
2.6	1839	1.6	530.7	20000	F 604_530.7 S1 M1LA4	122	F 604_530.7 P80	BN80A4	123

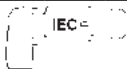

0.55 КВТ

n ₂ МИН-1	M ₂ Нм	S	i	R _{n2} Н						
2.7	1769	2.8	510.4	35000	F 704_510.4 S1	M1LA4	126	F 704_510.4 P80	BN80A4	127
2.8	1698	1.7	489.8	20000	F 604_489.8 S1	M1LA4	122	F 604_489.8 P80	BN80A4	123
2.9	1633	3.1	471.2	35000	F 704_471.2 S1	M1LA4	126	F 704_471.2 P80	BN80A4	127
3.2	1487	1.2	429.1	12000	F 514_429.1 S1	M1LA4	118	F 514_429.1 P80	BN80A4	119
3.2	1499	1.9	432.6	20000	F 604_432.6 S1	M1LA4	122	F 604_432.6 P80	BN80A4	123
3.5	1384	2.1	399.3	20000	F 604_399.3 S1	M1LA4	122	F 604_399.3 P80	BN80A4	123
3.9	1248	1.4	352.5	12000	F 513_352.5 S1	M1LA4	118	F 513_352.5 P80	BN80A4	119
4.0	1221	0.9	344.8	8500	F 413_344.8 S1	M1LA4	114	F 413_344.8 P80	BN80A4	115
4.0	1184	2.4	341.7	20000	F 604_341.7 S1	M1LA4	122	F 604_341.7 P80	BN80A4	123
4.3	1124	1.6	317.3	12000	F 513_317.3 S1	M1LA4	118	F 513_317.3 P80	BN80A4	119
4.4	1093	2.7	315.4	20000	F 604_315.4 S1	M1LA4	122	F 604_315.4 P80	BN80A4	123
4.7	1050	1.0	296.6	8500	F 413_296.6 S1	M1LA4	114	F 413_296.6 P80	BN80A4	115
4.8	1013	1.8	285.9	12000	F 513_285.9 S1	M1LA4	118	F 513_285.9 P80	BN80A4	119
5.2	945	1.2	266.9	8500	F 413_266.9 S1	M1LA4	114	F 413_266.9 P80	BN80A4	115
5.3	928	1.9	262.1	12000	F 513_262.1 S1	M1LA4	118	F 513_262.1 P80	BN80A4	119
5.7	850	1.3	240.1	8500	F 413_240.1 S1	M1LA4	114	F 413_240.1 P80	BN80A4	115
5.8	849	2.1	239.8	12000	F 513_239.8 S1	M1LA4	118	F 513_239.8 P80	BN80A4	119
6.3	780	1.4	220.1	8500	F 413_220.1 S1	M1LA4	114	F 413_220.1 P80	BN80A4	115
6.4	768	2.3	216.9	12000	F 513_216.9 S1	M1LA4	118	F 513_216.9 P80	BN80A4	119
6.8	717	2.5	202.4	12000	F 513_202.4 S1	M1LA4	118	F 513_202.4 P80	BN80A4	119
6.9	704	1.6	198.9	8500	F 413_198.9 S1	M1LA4	114	F 413_198.9 P80	BN80A4	115
7.4	657	0.9	185.4	6500	F 313_185.4 S1	M1LA4	110	F 313_185.4 P80	BN80A4	111
7.6	640	1.7	180.7	8500	F 413_180.7 S1	M1LA4	114	F 413_180.7 P80	BN80A4	115
8.2	597	1.8	168.7	8500	F 413_168.7 S1	M1LA4	114	F 413_168.7 P80	BN80A4	115
8.3	591	1.0	166.8	6500	F 313_166.8 S1	M1LA4	110	F 313_166.8 P80	BN80A4	111
8.3	587	3.1	165.6	12000	F 513_165.6 S1	M1LA4	118	F 513_165.6 P80	BN80A4	119
9.2	534	1.1	150.8	6500	F 313_150.8 S1	M1LA4	110	F 313_150.8 P80	BN80A4	111
9.8	498	1.2	140.7	6500	F 313_140.7 S1	M1LA4	110	F 313_140.7 P80	BN80A4	111
10.3	476	2.3	134.4	8500	F 413_134.4 S1	M1LA4	114	F 413_134.4 P80	BN80A4	115
10.7	455	1.3	128.4	6500	F 313_128.4 S1	M1LA4	110	F 313_128.4 P80	BN80A4	111
12.2	400	1.0	113.0	6130	F 253_113.0 S1	M1LA4	106	F 253_113.0 P80	BN80A4	107
12.3	399	1.5	112.5	6500	F 313_112.5 S1	M1LA4	110	F 313_112.5 P80	BN80A4	111
13.0	375	2.9	106.0	8500	F 413_106.0 S1	M1LA4	114	F 413_106.0 P80	BN80A4	115
13.1	373	1.1	105.4	6070	F 253_105.4 S1	M1LA4	106	F 253_105.4 P80	BN80A4	107
13.5	361	1.7	101.9	6500	F 313_101.9 S1	M1LA4	110	F 313_101.9 P80	BN80A4	111
14.5	338	1.2	95.5	5980	F 253_95.5 S1	M1LA4	106	F 253_95.5 P80	BN80A4	107
15.8	309	1.9	87.4	6500	F 313_87.4 S1	M1LA4	110	F 313_87.4 P80	BN80A4	111
16.5	295	1.4	83.4	5840	F 253_83.4 S1	M1LA4	106	F 253_83.4 P80	BN80A4	107
17.5	279	2.1	78.9	6500	F 313_78.9 S1	M1LA4	110	F 313_78.9 P80	BN80A4	111
18.0	278	0.9	76.8	4000	F 202_76.8 S1	M1LA4	102	F 202_76.8 P80	BN80A4	103
18.0	271	1.5	76.6	5750	F 253_76.6 S1	M1LA4	106	F 253_76.6 P80	BN80A4	107
20.0	250	1.0	69.1	3980	F 202_69.1 S1	M1LA4	102	F 202_69.1 P80	BN80A4	103
20.0	245	2.5	69.1	6500	F 313_69.1 S1	M1LA4	110	F 313_69.1 P80	BN80A4	111
21.1	231	1.7	65.3	5570	F 253_65.3 S1	M1LA4	106	F 253_65.3 P80	BN80A4	107
22.1	221	2.7	62.8	6500				F 313_62.8 P80	BN80A4	111
22.3	224	1.1	61.9	3890	F 202_61.9 S1	M1LA4	102	F 202_61.9 P80	BN80A4	103
23.7	207	1.9	58.3	5430	F 253_58.3 S1	M1LA4	106	F 253_58.3 P80	BN80A4	107
24.3	205	1.2	56.7	3810	F 202_56.7 S1	M1LA4	102	F 202_56.7 P80	BN80A4	103
26.7	183	3.3	52.1	6500				F 313_52.1 P80	BN80A4	111
27.2	184	1.4	50.7	3720	F 202_50.7 S1	M1LA4	102	F 202_50.7 P80	BN80A4	103
27.2	180	2.2	50.8	5270	F 253_50.8 S1	M1LA4	106	F 253_50.8 P80	BN80A4	107
29.2	167	3.5	47.5	6500				F 313_47.5 P80	BN80A4	111
31	162	1.5	44.8	3610	F 202_44.8 S1	M1LA4	102	F 202_44.8 P80	BN80A4	103
31	161	2.4	44.4	5140	F 252_44.4 S1	M1LA4	106	F 252_44.4 P80	BN80A4	107
31	160	2.5	45.6	5130				F 253_45.6 P80	BN80A4	107
33	151	1.7	41.8	3550	F 202_41.8 S1	M1LA4	102	F 202_41.8 P80	BN80A4	103
34	147	2.5	40.7	5030	F 252_40.7 S1	M1LA4	106	F 252_40.7 P80	BN80A4	107
35	143	1.0	39.6	2800	F 102_39.6 S1	M1LA4	98	F 102_39.6 P80	BN80A4	99
36	137	1.8	37.9	3460	F 202_37.9 S1	M1LA4	102	F 202_37.9 P80	BN80A4	103
38	132	3.0	36.4	4890	F 252_36.4 S1	M1LA4	106	F 252_36.4 P80	BN80A4	107
39	128	1.1	35.3	2800	F 102_35.3 S1	M1LA4	98	F 102_35.3 P80	BN80A4	99

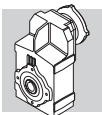

0.55 КВТ

n ₂ мин-1	M ₂ Нм	S	i	Rn ₂ Н					
42	119	1.2	33.0	2750	F 102_33.0 S1 M1LA4	98	F 102_33.0 P80 BN80A4		99
42	120	2.1	33.1	3340	F 202_33.1 S1 M1LA4	102	F 202_33.1 P80 BN80A4		103
43	116	3.4	32.2	4730	F 252_32.2 S1 M1LA4	106	F 252_32.2 P80 BN80A4		107
45	110	2.3	30.4	3260	F 202_30.4 S1 M1LA4	102	F 202_30.4 P80 BN80A4		103
47	107	1.3	29.6	2680	F 102_29.6 S1 M1LA4	98	F 102_29.6 P80 BN80A4		99
53	94	2.6	25.9	3130	F 202_25.9 S1 M1LA4	102	F 202_25.9 P80 BN80A4		103
54	93	1.5	25.8	2590	F 102_25.8 S1 M1LA4	98	F 102_25.8 P80 BN80A4		99
60	83	1.7	22.8	2510	F 102_22.8 S1 M1LA4	98	F 102_22.8 P80 BN80A4		99
60	84	2.8	23.1	3030	F 202_23.1 S1 M1LA4	102	F 202_23.1 P80 BN80A4		103
68	73	3.1	20.2	2910	F 202_20.2 S1 M1LA4	102	F 202_20.2 P80 BN80A4		103
71	70	1.9	19.3	2400	F 102_19.3 S1 M1LA4	98	F 102_19.3 P80 BN80A4		99
77	65	3.3	18.1	2820	F 202_18.1 S1 M1LA4	102	F 202_18.1 P80 BN80A4		103
81	61	2.1	17.0	2310	F 102_17.0 S1 M1LA4	98	F 102_17.0 P80 BN80A4		99
94	53	2.2	14.6	2220	F 102_14.6 S1 M1LA4	98	F 102_14.6 P80 BN80A4		99
106	47	2.2	13.0	2140	F 102_13.0 S1 M1LA4	98	F 102_13.0 P80 BN80A4		99
120	42	2.3	11.5	2070	F 102_11.5 S1 M1LA4	98	F 102_11.5 P80 BN80A4		99
141	35	2.5	9.8	1970	F 102_9.8 S1 M1LA4	98	F 102_9.8 P80 BN80A4		99
161	31	2.6	8.6	1890	F 102_8.6 S1 M1LA4	98	F 102_8.6 P80 BN80A4		99
186	27	2.8	7.4	1810	F 102_7.4 S1 M1LA4	98	F 102_7.4 P80 BN80A4		99
193	26	3.6	14.6	1800	F 102_14.6 S1 M1SD2	98	F 102_14.6 P71 BN71B2		99
216	23	3.7	13.0	1730	F 102_13.0 S1 M1SD2	98	F 102_13.0 P71 BN71B2		99
244	20	3.8	11.5	1670	F 102_11.5 S1 M1SD2	98	F 102_11.5 P71 BN71B2		99
289	17	4.2	9.8	1590	F 102_9.8 S1 M1SD2	98	F 102_9.8 P71 BN71B2		99
329	15	4.4	8.6	1530	F 102_8.6 S1 M1SD2	98	F 102_8.6 P71 BN71B2		99
381	13	4.8	7.4	1460	F 102_7.4 S1 M1SD2	98	F 102_7.4 P71 BN71B2		99

0.75 КВТ

n ₂ мин-1	M ₂ Нм	S	i	Rn ₂ Н					
0.44	14876	0.9	2099	55000	F 904_2099 S2 M2SB6	132	F 904_2099 P90 BN90S6		133
0.47	13732	1.0	1937	55000	F 904_1937 S2 M2SB6	132	F 904_1937 P90 BN90S6		133
0.54	12067	1.2	1702	55000	F 904_1702 S2 M2SB6	132	F 904_1702 P90 BN90S6		133
0.59	11138	1.3	1571	55000	F 904_1571 S2 M2SB6	132	F 904_1571 P90 BN90S6		133
0.64	10121	1.4	1428	55000	F 904_1428 S2 M2SB6	132	F 904_1428 P90 BN90S6		133
0.67	9776	1.4	2099	55000	F 904_2099 S2 M2SA4	132	F 904_2099 P80 BN80B4		133
0.70	9255	0.9	1987	45000	F 804_1987 S2 M2SA4	129	F 804_1987 P80 BN80B4		130
0.72	9024	1.6	1937	55000	F 904_1937 S2 M2SA4	132	F 904_1937 P80 BN80B4		133
0.76	8543	0.9	1834	45000	F 804_1834 S2 M2SA4	129	F 804_1834 P80 BN80B4		130
0.82	7961	1.0	1709	45000	F 804_1709 S2 M2SA4	129	F 804_1709 P80 BN80B4		130
0.82	7930	1.8	1702	55000	F 904_1702 S2 M2SA4	132	F 904_1702 P80 BN80B4		133
0.89	7349	1.1	1578	45000	F 804_1578 S2 M2SA4	129	F 804_1578 P80 BN80B4		130
0.89	7320	1.9	1571	55000	F 904_1571 S2 M2SA4	132	F 904_1571 P80 BN80B4		133
0.98	6651	2.1	1428	55000	F 904_1428 S2 M2SA4	132	F 904_1428 P80 BN80B4		133
1.0	6446	1.2	1384	45000	F 804_1384 S2 M2SA4	129	F 804_1384 P80 BN80B4		130
1.1	5950	1.3	1277	45000	F 804_1277 S2 M2SA4	129	F 804_1277 P80 BN80B4		130
1.1	6140	2.3	1318	55000	F 904_1318 S2 M2SA4	132	F 904_1318 P80 BN80B4		133
1.2	5505	0.9	1182	35000	F 704_1182 S2 M2SA4	126	F 704_1182 P80 BN80B4		127
1.2	5339	1.5	1146	45000	F 804_1146 S2 M2SA4	129	F 804_1146 P80 BN80B4		130
1.2	5613	2.5	1205	55000	F 904_1205 S2 M2SA4	132	F 904_1205 P80 BN80B4		133
1.3	5082	1.0	1091	35000	F 704_1091 S2 M2SA4	126	F 704_1091 P80 BN80B4		127
1.3	4929	1.6	1058	45000	F 804_1058 S2 M2SA4	129	F 804_1058 P80 BN80B4		130
1.3	5181	2.7	1112	55000	F 904_1112 S2 M2SA4	132	F 904_1112 P80 BN80B4		133
1.4	4539	1.1	974.4	35000	F 704_974.4 S2 M2SA4	126	F 704_974.4 P80 BN80B4		127
1.5	4240	3.3	910.2	55000	F 904_910.2 S2 M2SA4	132	F 904_910.2 P80 BN80B4		133
1.6	4190	1.2	899.4	35000	F 704_899.4 S2 M2SA4	126	F 704_899.4 P80 BN80B4		127
1.6	4180	1.9	897.3	45000	F 804_897.3 S2 M2SA4	129	F 804_897.3 P80 BN80B4		130
1.7	3830	1.3	822.2	35000	F 704_822.2 S2 M2SA4	126	F 704_822.2 P80 BN80B4		127
1.8	3607	2.2	774.4	45000	F 804_774.4 S2 M2SA4	129	F 804_774.4 P80 BN80B4		130

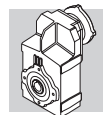

0.75 КВТ

n ₂ МИН-1	M ₂ Нм	S	i	R _{n2} Н					
2.0	3330	2.4	714.9	45000	F 804_714.9 S2 M2SA4	129	F 804_714.9 P80	BN80B4	130
2.1	3085	0.9	662.4	20000	F 604_662.4 S2 M2SA4	122	F 604_662.4 P80	BN80B4	123
2.1	3062	1.6	657.4	35000	F 704_657.4 S2 M2SA4	126	F 704_657.4 P80	BN80B4	127
2.3	2848	1.0	611.4	20000	F 604_611.4 S2 M2SA4	122	F 604_611.4 P80	BN80B4	123
2.3	2827	1.8	606.8	35000	F 704_606.8 S2 M2SA4	126	F 704_606.8 P80	BN80B4	127
2.3	2845	2.8	610.9	45000	F 804_610.9 S2 M2SA4	129	F 804_610.9 P80	BN80B4	130
2.5	2627	3.0	563.9	45000	F 804_563.9 S2 M2SA4	129	F 804_563.9 P80	BN80B4	130
2.6	2472	1.2	530.7	20000	F 604_530.7 S2 M2SA4	122	F 604_530.7 P80	BN80B4	123
2.7	2378	2.1	510.4	35000	F 704_510.4 S2 M2SA4	126	F 704_510.4 P80	BN80B4	127
2.9	2282	1.3	489.8	20000	F 604_489.8 S2 M2SA4	122	F 604_489.8 P80	BN80B4	123
2.9	2278	3.5	489.1	45000	F 804_489.1 S2 M2SA4	129	F 804_489.1 P80	BN80B4	130
3.0	2195	2.3	471.2	35000	F 704_471.2 S2 M2SA4	126	F 704_471.2 P80	BN80B4	127
3.2	2015	1.4	432.6	20000	F 604_432.6 S2 M2SA4	122	F 604_432.6 P80	BN80B4	123
3.3	1999	0.9	429.1	12000	F 514_429.1 S2 M2SA4	118	F 514_429.1 P80	BN80B4	119
3.5	1860	1.6	399.3	20000	F 604_399.3 S2 M2SA4	122	F 604_399.3 P80	BN80B4	123
3.5	1880	2.7	403.5	35000	F 704_403.5 S2 M2SA4	126	F 704_403.5 P80	BN80B4	127
3.8	1735	2.9	372.5	35000	F 704_372.5 S2 M2SA4	126	F 704_372.5 P80	BN80B4	127
4.0	1678	1.1	352.5	12000	F 513_352.5 S2 M2SA4	118	F 513_352.5 P80	BN80B4	119
4.1	1592	1.8	341.7	20000	F 604_341.7 S2 M2SA4	122	F 604_341.7 P80	BN80B4	123
4.4	1510	1.2	317.3	12000	F 513_317.3 S2 M2SA4	118	F 513_317.3 P80	BN80B4	119
4.4	1469	2.0	315.4	20000	F 604_315.4 S2 M2SA4	122	F 604_315.4 P80	BN80B4	123
4.6	1418	3.5	304.3	35000	F 704_304.3 S2 M2SA4	126	F 704_304.3 P80	BN80B4	127
4.9	1361	1.3	285.9	12000	F 513_285.9 S2 M2SA4	118	F 513_285.9 P80	BN80B4	119
5.3	1248	1.4	262.1	12000	F 513_262.1 S2 M2SA4	118	F 513_262.1 P80	BN80B4	119
5.8	1143	1.0	240.1	8500	F 413_240.1 S2 M2SA4	114	F 413_240.1 P80	BN80B4	115
5.8	1142	1.6	239.8	12000	F 513_239.8 S2 M2SA4	118	F 513_239.8 P80	BN80B4	119
6.4	1048	1.0	220.1	8500	F 413_220.1 S2 M2SA4	114	F 413_220.1 P80	BN80B4	115
6.5	1032	1.7	216.9	12000	F 513_216.9 S2 M2SA4	118	F 513_216.9 P80	BN80B4	119
6.9	963	1.9	202.4	12000	F 513_202.4 S2 M2SA4	118	F 513_202.4 P80	BN80B4	119
7.0	947	1.2	198.9	8500	F 413_198.9 S2 M2SA4	114	F 413_198.9 P80	BN80B4	115
7.7	860	1.3	180.7	8500	F 413_180.7 S2 M2SA4	114	F 413_180.7 P80	BN80B4	115
8.3	803	1.4	168.7	8500	F 413_168.7 S2 M2SA4	114	F 413_168.7 P80	BN80B4	115
8.5	788	2.3	165.6	12000	F 513_165.6 S2 M2SA4	118	F 513_165.6 P80	BN80B4	119
10.4	640	1.7	134.4	8500	F 413_134.4 S2 M2SA4	114	F 413_134.4 P80	BN80B4	115
10.8	618	2.9	129.9	12000	F 513_129.9 S2 M2SA4	118	F 513_129.9 P80	BN80B4	119
10.9	611	1.0	128.4	6500	F 313_128.4 S2 M2SA4	110	F 313_128.4 P80	BN80B4	111
12.4	536	1.1	112.5	6500	F 313_112.5 S2 M2SA4	110	F 313_112.5 P80	BN80B4	111
13.2	505	2.2	106.0	8500	F 413_106.0 S2 M2SA4	114	F 413_106.0 P80	BN80B4	115
13.7	485	1.2	101.9	6500	F 313_101.9 S2 M2SA4	110	F 313_101.9 P80	BN80B4	111
16.0	416	1.4	87.4	6500	F 313_87.4 S2 M2SA4	110	F 313_87.4 P80	BN80B4	111
16.5	404	2.7	84.9	8500	F 413_84.9 S2 M2SA4	114	F 413_84.9 P80	BN80B4	115
16.8	397	1.0	83.4	5350	F 253_83.4 S2 M2SA4	106	F 253_83.4 P80	BN80B4	107
17.8	375	1.6	78.9	6500	F 313_78.9 S2 M2SA4	110	F 313_78.9 P80	BN80B4	111
18.3	365	1.1	76.6	5300	F 253_76.6 S2 M2SA4	106	F 253_76.6 P80	BN80B4	107
20.3	329	1.8	69.1	6500	F 313_69.1 S2 M2SA4	110	F 313_69.1 P80	BN80B4	111
21.1	317	3.5	66.5	8500	F 413_66.5 S2 M2SA4	114	F 413_66.5 P80	BN80B4	115
21.4	311	1.3	65.3	5180	F 253_65.3 S2 M2SA4	106	F 253_65.3 P80	BN80B4	107
22.3	299	2.0	62.8	6500	F 313_62.8 S2 M2SA4	110	F 313_62.8 P80	BN80B4	111
24.0	278	1.4	58.3	5080	F 253_58.3 S2 M2SA4	106	F 253_58.3 P80	BN80B4	107
24.7	276	0.9	56.7	3590	F 202_56.7 S2 M2SA4	102	F 202_56.7 P80	BN80B4	103
26.9	248	2.4	52.1	6500	F 313_52.1 S2 M2SA4	110	F 313_52.1 P80	BN80B4	111
27.6	247	1.0	50.7	3510	F 202_50.7 S2 M2SA4	102	F 202_50.7 P80	BN80B4	103
27.6	242	1.7	50.8	4960	F 253_50.8 S2 M2SA4	106	F 253_50.8 P80	BN80B4	107
29.4	226	2.6	47.5	6500	F 313_47.5 S2 M2SA4	110	F 313_47.5 P80	BN80B4	111
31	218	1.1	44.8	3420	F 202_44.8 S2 M2SA4	102	F 202_44.8 P80	BN80B4	103
31	217	1.8	45.6	4860	F 253_45.6 S2 M2SA4	106	F 253_45.6 P80	BN80B4	107
31	217	2.8	44.6	6500	F 312_44.6 S2 M2SA4	110	F 312_44.6 P80	BN80B4	111
32	216	1.8	44.4	4890	F 252_44.4 S2 M2SA4	106	F 252_44.4 P80	BN80B4	107
33	203	1.2	41.8	3370	F 202_41.8 S2 M2SA4	102	F 202_41.8 P80	BN80B4	103
34	198	1.9	40.7	4790	F 252_40.7 S2 M2SA4	106	F 252_40.7 P80	BN80B4	107
35	196	3.1	40.4	6500	F 312_40.4 S2 M2SA4	110	F 312_40.4 P80	BN80B4	111

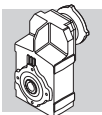

0.75 КВТ

n ₂ мин-1	M ₂ Нм	S	i	R _{n2} Н					
37	184	1.4	37.9	3300	F 202_37.9 S2	M2SA4	102	F 202_37.9 P80 BN80B4	103
37	183	3.3	37.7	6500	F 312_37.7 S2	M2SA4	110	F 312_37.7 P80 BN80B4	111
38	177	2.3	36.4	4680	F 252_36.4 S2	M2SA4	106	F 252_36.4 P80 BN80B4	107
42	161	1.6	33.1	3200	F 202_33.1 S2	M2SA4	102	F 202_33.1 P80 BN80B4	103
44	156	2.6	32.2	4540	F 252_32.2 S2	M2SA4	106	F 252_32.2 P80 BN80B4	107
46	148	1.7	30.4	3140	F 202_30.4 S2	M2SA4	102	F 202_30.4 P80 BN80B4	103
47	144	1.0	29.6	2550	F 102_29.6 S2	M2SA4	98	F 102_29.6 P80 BN80B4	99
47	146	2.7	30.0	4470	F 252_30.0 S2	M2SA4	106	F 252_30.0 P80 BN80B4	107
51	132	3.0	27.2	4360	F 252_27.2 S2	M2SA4	106	F 252_27.2 P80 BN80B4	107
54	125	1.1	25.8	2470	F 102_25.8 S2	M2SA4	98	F 102_25.8 P80 BN80B4	99
54	126	1.9	25.9	3020	F 202_25.9 S2	M2SA4	102	F 202_25.9 P80 BN80B4	103
59	116	3.5	23.8	4210	F 252_23.8 S2	M2SA4	106	F 252_23.8 P80 BN80B4	107
60	113	2.1	23.1	2930	F 202_23.1 S2	M2SA4	102	F 202_23.1 P80 BN80B4	103
61	111	1.3	22.8	2400	F 102_22.8 S2	M2SA4	98	F 102_22.8 P80 BN80B4	99
69	98	2.3	20.2	2830	F 202_20.2 S2	M2SA4	102	F 202_20.2 P80 BN80B4	103
72	94	1.4	19.3	2310	F 102_19.3 S2	M2SA4	98	F 102_19.3 P80 BN80B4	99
77	88	2.4	18.1	2740	F 202_18.1 S2	M2SA4	102	F 202_18.1 P80 BN80B4	103
82	83	1.6	17.0	2230	F 102_17.0 S2	M2SA4	98	F 102_17.0 P80 BN80B4	99
95	72	2.8	14.8	2600	F 202_14.8 S2	M2SA4	102	F 202_14.8 P80 BN80B4	103
96	71	1.7	14.6	2150	F 102_14.6 S2	M2SA4	98	F 102_14.6 P80 BN80B4	99
107	63	1.6	13.0	2070	F 102_13.0 S2	M2SA4	98	F 102_13.0 P80 BN80B4	99
121	56	1.7	11.5	2010	F 102_11.5 S2	M2SA4	98	F 102_11.5 P80 BN80B4	99
125	55	3.2	11.2	2390	F 202_11.2 S2	M2SA4	102	F 202_11.2 P80 BN80B4	103
143	48	1.9	9.8	1920	F 102_9.8 S2	M2SA4	98	F 102_9.8 P80 BN80B4	99
163	42	2.0	8.6	1850	F 102_8.6 S2	M2SA4	98	F 102_8.6 P80 BN80B4	99
189	36	2.1	7.4	1770	F 102_7.4 S2	M2SA4	98	F 102_7.4 P80 BN80B4	99
192	35	2.6	14.6	1770	F 102_14.6 S1	M1LA2	98	F 102_14.6 P80 BN80A2	99
216	32	2.7	13.0	1710	F 102_13.0 S1	M1LA2	98	F 102_13.0 P80 BN80A2	99
244	28	2.8	11.5	1650	F 102_11.5 S1	M1LA2	98	F 102_11.5 P80 BN80A2	99
288	24	3.1	9.8	1570	F 102_9.8 S1	M1LA2	98	F 102_9.8 P80 BN80A2	99
327	21	3.2	8.6	1510	F 102_8.6 S1	M1LA2	98	F 102_8.6 P80 BN80A2	99
380	18	3.5	7.4	1440	F 102_7.4 S1	M1LA2	98	F 102_7.4 P80 BN80A2	99

1.1 КВТ

n ₂ мин-1	M ₂ Нм	S	i	R _{n2} Н					
0.59	16336	0.9	1571	55000	F 904_1571 S3	M3SA6	132	F 904_1571 P90 BN90L6	133
0.64	14845	0.9	1428	55000	F 904_1428 S3	M3SA6	132	F 904_1428 P90 BN90L6	133
0.67	14338	1.0	2099	55000	F 904_2099 S2	M2SB4	132	F 904_2099 P90 BN90S4	133
0.72	13235	1.1	1937	55000	F 904_1937 S2	M2SB4	132	F 904_1937 P90 BN90S4	133
0.82	11630	1.2	1702	55000	F 904_1702 S2	M2SB4	132	F 904_1702 P90 BN90S4	133
0.89	10735	1.3	1571	55000	F 904_1571 S2	M2SB4	132	F 904_1571 P90 BN90S4	133
0.98	9755	1.4	1428	55000	F 904_1428 S2	M2SB4	132	F 904_1428 P90 BN90S4	133
1.1	8727	0.9	1277	45000	F 804_1277 S2	M2SB4	129	F 804_1277 P90 BN90S4	130
1.1	9005	1.6	1318	55000	F 904_1318 S2	M2SB4	132	F 904_1318 P90 BN90S4	133
1.2	7831	1.0	1146	45000	F 804_1146 S2	M2SB4	129	F 804_1146 P90 BN90S4	130
1.2	8232	1.7	1205	55000	F 904_1205 S2	M2SB4	132	F 904_1205 P90 BN90S4	133
1.3	7229	1.1	1058	45000	F 804_1058 S2	M2SB4	129	F 804_1058 P90 BN90S4	130
1.3	7599	1.8	1112	55000	F 904_1112 S2	M2SB4	132	F 904_1112 P90 BN90S4	133
1.5	6218	2.3	910.2	55000	F 904_910.2 S2	M2SB4	132	F 904_910.2 P90 BN90S4	133
1.6	6130	1.3	897.3	45000	F 804_897.3 S2	M2SB4	129	F 804_897.3 P90 BN90S4	130
1.7	5617	0.9	822.2	35000	F 704_822.2 S2	M2SB4	126	F 704_822.2 P90 BN90S4	127
1.8	5291	1.5	774.4	45000	F 804_774.4 S2	M2SB4	129	F 804_774.4 P90 BN90S4	130
1.8	5284	2.6	773.4	55000	F 904_773.4 S2	M2SB4	132	F 904_773.4 P90 BN90S4	133
1.9	5085	1.6	489.1	45000	F 804_489.1 S3	M3SA6	129	F 804_489.1 P90 BN90L6	130
1.9	5152	2.7	495.6	55000	F 904_495.6 S3	M3SA6	132	F 904_495.6 P90 BN90L6	133

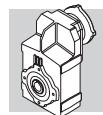

1.1 КВТ

n ₂ МИН-1	M ₂ Нм	S	i	R _{n2} Н					
2.0	4898	1.0	471.2	35000	F 704_471.2 S3	M3SA6	126	F 704_471.2 P90 BN90L6	127
2.0	4694	1.7	451.5	45000	F 804_451.5 S3	M3SA6	129	F 804_451.5 P90 BN90L6	130
2.0	4884	1.6	714.9	45000	F 804_714.9 S2	M2SB4	129	F 804_714.9 P90 BN90S4	130
2.1	4491	1.1	657.4	35000	F 704_657.4 S2	M2SB4	126	F 704_657.4 P90 BN90S4	127
2.2	4274	3.3	625.6	55000	F 904_625.6 S2	M2SB4	132	F 904_625.6 P90 BN90S4	133
2.3	4146	1.2	606.8	35000	F 704_606.8 S2	M2SB4	126	F 704_606.8 P90 BN90S4	127
2.3	4173	1.9	610.9	45000	F 804_610.9 S2	M2SB4	129	F 804_610.9 P90 BN90S4	130
2.4	3945	3.5	577.5	55000	F 904_577.5 S2	M2SB4	132	F 904_577.5 P90 BN90S4	133
2.5	3852	2.1	563.9	45000	F 804_563.9 S2	M2SB4	129	F 804_563.9 P90 BN90S4	130
2.7	3487	1.4	510.4	35000	F 704_510.4 S2	M2SB4	126	F 704_510.4 P90 BN90S4	127
2.9	3347	0.9	489.8	20000	F 604_489.8 S2	M2SB4	122	F 604_489.8 P90 BN90S4	123
2.9	3342	2.4	489.1	45000	F 804_489.1 S2	M2SB4	129	F 804_489.1 P90 BN90S4	130
3.0	3219	1.6	471.2	35000	F 704_471.2 S2	M2SB4	126	F 704_471.2 P90 BN90S4	127
3.1	3085	2.6	451.5	45000	F 804_451.5 S2	M2SB4	129	F 804_451.5 P90 BN90S4	130
3.2	2956	1.0	432.6	20000	F 604_432.6 S2	M2SB4	122	F 604_432.6 P90 BN90S4	123
3.5	2728	1.1	399.3	20000	F 604_399.3 S2	M2SB4	122	F 604_399.3 P90 BN90S4	123
3.5	2757	1.8	403.5	35000	F 704_403.5 S2	M2SB4	126	F 704_403.5 P90 BN90S4	127
3.7	2618	3.1	383.2	45000	F 804_383.2 S2	M2SB4	129	F 804_383.2 P90 BN90S4	130
3.8	2545	2.0	372.5	35000	F 704_372.5 S2	M2SB4	126	F 704_372.5 P90 BN90S4	127
4.0	2416	3.3	353.7	45000	F 804_353.7 S2	M2SB4	129	F 804_353.7 P90 BN90S4	130
4.1	2334	1.2	341.7	20000	F 604_341.7 S2	M2SB4	122	F 604_341.7 P90 BN90S4	123
4.4	2155	1.3	315.4	20000	F 604_315.4 S2	M2SB4	122	F 604_315.4 P90 BN90S4	123
4.6	2079	2.4	304.3	35000	F 704_304.3 S2	M2SB4	126	F 704_304.3 P90 BN90S4	127
4.9	1996	0.9	285.9	12000	F 513_285.9 S2	M2SB4	118	F 513_285.9 P90 BN90S4	119
5.0	1960	1.5	280.7	20000	F 603_280.7 S2	M2SB4	122	F 603_280.7 P90 BN90S4	123
5.0	1919	2.6	280.9	35000	F 704_280.9 S2	M2SB4	126	F 704_280.9 P90 BN90S4	127
5.3	1830	1.0	262.1	12000	F 513_262.1 S2	M2SB4	118	F 513_262.1 P90 BN90S4	119
5.8	1675	1.1	239.8	12000	F 513_239.8 S2	M2SB4	118	F 513_239.8 P90 BN90S4	119
6.0	1603	3.1	234.6	35000	F 704_234.6 S2	M2SB4	126	F 704_234.6 P90 BN90S4	127
6.5	1514	1.2	216.9	12000	F 513_216.9 S2	M2SB4	118	F 513_216.9 P90 BN90S4	119
6.5	1479	3.4	216.5	35000	F 704_216.5 S2	M2SB4	126	F 704_216.5 P90 BN90S4	127
6.9	1413	1.3	202.4	12000	F 513_202.4 S2	M2SB4	118	F 513_202.4 P90 BN90S4	119
8.3	1178	0.9	168.7	8500	F 413_168.7 S2	M2SB4	114	F 413_168.7 P90 BN90S4	115
8.5	1156	1.6	165.6	12000	F 513_165.6 S2	M2SB4	118	F 513_165.6 P90 BN90S4	119
10.4	938	1.2	134.4	8500	F 413_134.4 S2	M2SB4	114	F 413_134.4 P90 BN90S4	115
10.8	907	2.0	129.9	12000	F 513_129.9 S2	M2SB4	118	F 513_129.9 P90 BN90S4	119
13.2	740	1.5	106.0	8500	F 413_106.0 S2	M2SB4	114	F 413_106.0 P90 BN90S4	115
13.3	734	2.5	105.1	12000	F 513_105.1 S2	M2SB4	118	F 513_105.1 P90 BN90S4	119
16.0	610	1.0	87.4	6500	F 313_87.4 S2	M2SB4	110	F 313_87.4 P90 BN90S4	111
16.5	593	1.9	84.9	8500	F 413_84.9 S2	M2SB4	114	F 413_84.9 P90 BN90S4	115
16.8	581	3.1	83.2	12000	F 513_83.2 S2	M2SB4	118	F 513_83.2 P90 BN90S4	119
17.8	551	1.1	78.9	6500	F 313_78.9 S2	M2SB4	110	F 313_78.9 P90 BN90S4	111
20.3	482	1.2	69.1	6500	F 313_69.1 S2	M2SB4	110	F 313_69.1 P90 BN90S4	111
21.1	464	2.4	66.5	8500	F 413_66.5 S2	M2SB4	114	F 413_66.5 P90 BN90S4	115
22.3	438	1.4	62.8	6500	F 313_62.8 S2	M2SB4	110	F 313_62.8 P90 BN90S4	111
23.2	421	2.6	60.2	8500	F 413_60.2 S2	M2SB4	114	F 413_60.2 P90 BN90S4	115
24.0	407	1.0	58.3	4500	F 253_58.3 S2	M2SB4	106	F 253_58.3 P90 BN90S4	107
26.9	364	1.6	52.1	6500	F 313_52.1 S2	M2SB4	110	F 313_52.1 P90 BN90S4	111
27.2	360	3.0	51.5	8500	F 413_51.5 S2	M2SB4	114	F 413_51.5 P90 BN90S4	115
27.6	355	1.1	50.8	4450	F 253_50.8 S2	M2SB4	106	F 253_50.8 P90 BN90S4	107
29.2	342	3.1	47.9	8500	F 412_47.9 S2	M2SB4	114	F 412_47.9 P90 BN90S4	115
29.4	332	1.7	47.5	6500	F 313_47.5 S2	M2SB4	110	F 313_47.5 P90 BN90S4	111
31	318	1.3	45.6	4400	F 253_45.6 S2	M2SB4	106	F 253_45.6 P90 BN90S4	107
31	318	1.9	44.6	6500	F 312_44.6 S2	M2SB4	110	F 312_44.6 P90 BN90S4	111
32	317	1.2	44.4	4470	F 252_44.4 S2	M2SB4	106	F 252_44.4 P90 BN90S4	107
34	290	1.3	40.7	4410	F 252_40.7 S2	M2SB4	106	F 252_40.7 P90 BN90S4	107
35	288	2.1	40.4	6500	F 312_40.4 S2	M2SB4	110	F 312_40.4 P90 BN90S4	111
37	270	0.9	37.9	3050	F 202_37.9 S2	M2SB4	102	F 202_37.9 P90 BN90S4	103
37	269	2.2	37.7	6500	F 312_37.7 S2	M2SB4	110	F 312_37.7 P90 BN90S4	111
38	260	1.5	36.4	4330	F 252_36.4 S2	M2SB4	106	F 252_36.4 P90 BN90S4	107
41	245	2.4	34.4	6500	F 312_34.4 S2	M2SB4	110	F 312_34.4 P90 BN90S4	111

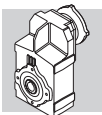

1.1 кВТ

n ₂ мин-1	M ₂ Нм	S	i	R _{n2} Н					
42	236	1.1	33.1	2980	F 202_33.1 S2 M2SB4	102	F 202_33.1 P90 BN90S4		103
44	230	1.7	32.2	4240	F 252_32.2 S2 M2SB4	106	F 252_32.2 P90 BN90S4		107
46	217	1.2	30.4	2930	F 202_30.4 S2 M2SB4	102	F 202_30.4 P90 BN90S4		103
46	215	2.8	30.1	6500	F 312_30.1 S2 M2SB4	110	F 312_30.1 P90 BN90S4		111
47	214	1.9	30.0	4190	F 252_30.0 S2 M2SB4	106	F 252_30.0 P90 BN90S4		107
51	194	2.1	27.2	4100	F 252_27.2 S2 M2SB4	106	F 252_27.2 P90 BN90S4		107
51	195	3.1	27.3	6500	F 312_27.3 S2 M2SB4	110	F 312_27.3 P90 BN90S4		111
54	185	1.3	25.9	2840	F 202_25.9 S2 M2SB4	102	F 202_25.9 P90 BN90S4		103
59	169	2.4	23.8	3990	F 252_23.8 S2 M2SB4	106	F 252_23.8 P90 BN90S4		107
60	165	1.4	23.1	2780	F 202_23.1 S2 M2SB4	102	F 202_23.1 P90 BN90S4		103
64	156	2.6	21.8	3920	F 252_21.8 S2 M2SB4	106	F 252_21.8 P90 BN90S4		107
69	144	1.6	20.2	2690	F 202_20.2 S2 M2SB4	102	F 202_20.2 P90 BN90S4		103
72	138	1.0	19.3	2170	F 102_19.3 S2 M2SB4	98	F 102_19.3 P90 BN90S4		99
75	133	3.0	18.6	3780	F 252_18.6 S2 M2SB4	106	F 252_18.6 P90 BN90S4		107
77	129	1.7	18.1	2620	F 202_18.1 S2 M2SB4	102	F 202_18.1 P90 BN90S4		103
82	121	1.1	17.0	2110	F 102_17.0 S2 M2SB4	98	F 102_17.0 P90 BN90S4		99
84	119	3.4	16.6	3670	F 252_16.6 S2 M2SB4	106	F 252_16.6 P90 BN90S4		107
95	106	1.9	14.8	2500	F 202_14.8 S2 M2SB4	102	F 202_14.8 P90 BN90S4		103
96	104	1.1	14.6	2050	F 102_14.6 S2 M2SB4	98	F 102_14.6 P90 BN90S4		99
107	93	1.1	13.0	1980	F 102_13.0 S2 M2SB4	98	F 102_13.0 P90 BN90S4		99
121	82	1.2	11.5	1920	F 102_11.5 S2 M2SB4	98	F 102_11.5 P90 BN90S4		99
125	80	2.2	11.2	2310	F 202_11.2 S2 M2SB4	102	F 202_11.2 P90 BN90S4		103
143	70	1.3	9.8	1840	F 102_9.8 S2 M2SB4	98	F 102_9.8 P90 BN90S4		99
160	62	2.5	8.7	2160	F 202_8.7 S2 M2SB4	102	F 202_8.7 P90 BN90S4		103
163	61	1.3	8.6	1780	F 102_8.6 S2 M2SB4	98	F 102_8.6 P90 BN90S4		99
179	56	2.6	7.8	2100	F 202_7.8 S2 M2SB4	102	F 202_7.8 P90 BN90S4		103
189	53	1.4	7.4	1720	F 102_7.4 S2 M2SB4	98	F 102_7.4 P90 BN90S4		99
218	46	2.8	6.4	1980	F 202_6.4 S2 M2SB4	102	F 202_6.4 P90 BN90S4		103
243	41	1.9	11.5	1600	F 102_11.5 S2 M2SA2	98	F 102_11.5 P80 BN80B2		99
249	40	3.5	11.2	1910	F 202_11.2 S2 M2SA2	102	F 202_11.2 P80 BN80B2		103
287	35	2.1	9.8	1530	F 102_9.8 S2 M2SA2	98	F 102_9.8 P80 BN80B2		99
326	31	2.2	8.6	1480	F 102_8.6 S2 M2SA2	98	F 102_8.6 P80 BN80B2		99
378	26	2.4	7.4	1410	F 102_7.4 S2 M2SA2	98	F 102_7.4 P80 BN80B2		99

1.5 кВТ

n ₂ мин-1	M ₂ Нм	S	i	R _{n2} Н					
0.83	15747	0.9	1702	55000	F 904_1702 S3 M3SA4	132	F 904_1702 P90 BN90LA4		133
0.90	14535	1.0	1571	55000	F 904_1571 S3 M3SA4	132	F 904_1571 P90 BN90LA4		133
0.99	13208	1.1	1428	55000	F 904_1428 S3 M3SA4	132	F 904_1428 P90 BN90LA4		133
1.1	12192	1.1	1318	55000	F 904_1318 S3 M3SA4	132	F 904_1318 P90 BN90LA4		133
1.2	11146	1.3	1205	55000	F 904_1205 S3 M3SA4	132	F 904_1205 P90 BN90LA4		133
1.3	10288	1.4	1112	55000	F 904_1112 S3 M3SA4	132	F 904_1112 P90 BN90LA4		133
1.5	8419	1.7	910.2	55000	F 904_910.2 S3 M3SA4	132	F 904_910.2 P90 BN90LA4		133
1.6	8300	1.0	897.3	45000	F 804_897.3 S3 M3SA4	129	F 804_897.3 P90 BN90LA4		130
1.8	7164	1.1	774.4	45000	F 804_774.4 S3 M3SA4	129	F 804_774.4 P90 BN90LA4		130
1.8	7154	2.0	773.4	55000	F 904_773.4 S3 M3SA4	132	F 904_773.4 P90 BN90LA4		133
2.0	6612	1.2	714.9	45000	F 804_714.9 S3 M3SA4	129	F 804_714.9 P90 BN90LA4		130
2.3	5613	0.9	606.8	35000	F 704_606.8 S3 M3SA4	126	F 704_606.8 P90 BN90LA4		127
2.3	5651	1.4	610.9	45000	F 804_610.9 S3 M3SA4	129	F 804_610.9 P90 BN90LA4		130
2.3	5787	2.4	625.6	55000	F 904_625.6 S3 M3SA4	132	F 904_625.6 P90 BN90LA4		133
2.4	5342	2.6	577.5	55000	F 904_577.5 S3 M3SA4	132	F 904_577.5 P90 BN90LA4		133
2.5	5216	1.5	563.9	45000	F 804_563.9 S3 M3SA4	129	F 804_563.9 P90 BN90LA4		130
2.8	4721	1.1	510.4	35000	F 704_510.4 S3 M3SA4	126	F 704_510.4 P90 BN90LA4		127
2.8	4584	3.1	495.6	55000	F 904_495.6 S3 M3SA4	132	F 904_495.6 P90 BN90LA4		133
2.9	4524	1.8	489.1	45000	F 804_489.1 S3 M3SA4	129	F 804_489.1 P90 BN90LA4		130
3.0	4358	1.1	471.2	35000	F 704_471.2 S3 M3SA4	126	F 704_471.2 P90 BN90LA4		127

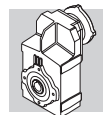

1.5 КВТ

n ₂ МИН-1	M ₂ Нм	S	i	R _{n2} Н			IEC			
3.1	4176	1.9	451.5	45000	F 804_451.5 S3	M3SA4	129	F 804_451.5 P90	BN90LA4	130
3.1	4231	3.3	457.5	55000	F 904_457.5 S3	M3SA4	132	F 904_457.5 P90	BN90LA4	133
3.5	3732	1.3	403.5	35000	F 704_403.5 S3	M3SA4	126	F 704_403.5 P90	BN90LA4	127
3.7	3544	2.3	383.2	45000	F 804_383.2 S3	M3SA4	129	F 804_383.2 P90	BN90LA4	130
3.8	3445	1.5	372.5	35000	F 704_372.5 S3	M3SA4	126	F 704_372.5 P90	BN90LA4	127
4.0	3272	2.4	353.7	45000	F 804_353.7 S3	M3SA4	129	F 804_353.7 P90	BN90LA4	130
4.1	3160	0.9	341.7	20000	F 604_341.7 S3	M3SA4	122	F 604_341.7 P90	BN90LA4	123
4.5	2917	1.0	315.4	20000	F 604_315.4 S3	M3SA4	122	F 604_315.4 P90	BN90LA4	123
4.6	2815	1.8	304.3	35000	F 704_304.3 S3	M3SA4	126	F 704_304.3 P90	BN90LA4	127
4.8	2745	2.9	296.7	45000	F 804_296.7 S3	M3SA4	129	F 804_296.7 P90	BN90LA4	130
5.0	2653	1.1	280.7	20000	F 603_280.7 S3	M3SA4	122	F 603_280.7 P90	BN90LA4	123
5.0	2599	1.9	280.9	35000	F 704_280.9 S3	M3SA4	126	F 704_280.9 P90	BN90LA4	127
5.1	2534	3.2	273.9	45000	F 804_273.9 S3	M3SA4	129	F 804_273.9 P90	BN90LA4	130
5.4	2449	1.2	259.1	20000	F 603_259.1 S3	M3SA4	122	F 603_259.1 P90	BN90LA4	123
6.0	2229	1.3	235.8	20000	F 603_235.8 S3	M3SA4	122	F 603_235.8 P90	BN90LA4	123
6.0	2170	2.3	234.6	35000	F 704_234.6 S3	M3SA4	126	F 704_234.6 P90	BN90LA4	127
6.5	2057	1.4	217.6	20000	F 603_217.6 S3	M3SA4	122	F 603_217.6 P90	BN90LA4	123
6.5	2003	2.5	216.5	35000	F 704_216.5 S3	M3SA4	126	F 704_216.5 P90	BN90LA4	127
7.0	1913	0.9	202.4	12000	F 513_202.4 S3	M3SA4	118	F 513_202.4 P90	BN90LA4	119
7.0	1904	1.5	201.4	20000	F 603_201.4 S3	M3SA4	122	F 603_201.4 P90	BN90LA4	123
7.2	1853	2.7	196.0	35000	F 703_196.0 S3	M3SA4	126	F 703_196.0 P90	BN90LA4	127
7.6	1757	1.7	185.9	20000	F 603_185.9 S3	M3SA4	122	F 603_185.9 P90	BN90LA4	123
7.8	1711	2.9	180.9	35000	F 703_180.9 S3	M3SA4	126	F 703_180.9 P90	BN90LA4	127
8.5	1566	1.1	165.6	12000	F 513_165.6 S3	M3SA4	118	F 513_165.6 P90	BN90LA4	119
8.5	1576	3.2	166.7	35000	F 703_166.7 S3	M3SA4	126	F 703_166.7 P90	BN90LA4	127
8.7	1540	1.9	162.9	20000	F 603_162.9 S3	M3SA4	122	F 603_162.9 P90	BN90LA4	123
9.2	1454	3.4	153.8	35000	F 703_153.8 S3	M3SA4	126	F 703_153.8 P90	BN90LA4	127
9.4	1421	2.0	150.4	20000	F 603_150.4 S3	M3SA4	122	F 603_150.4 P90	BN90LA4	123
10.8	1234	2.4	130.5	20000	F 603_130.5 S3	M3SA4	122	F 603_130.5 P90	BN90LA4	123
10.9	1228	1.5	129.9	12000	F 513_129.9 S3	M3SA4	118	F 513_129.9 P90	BN90LA4	119
11.7	1139	2.5	120.5	20000	F 603_120.5 S3	M3SA4	122	F 603_120.5 P90	BN90LA4	123
13.3	1002	1.1	106.0	8500	F 413_106.0 S3	M3SA4	114	F 413_106.0 P90	BN90LA4	115
13.3	1006	2.9	106.4	20000	F 603_106.4 S3	M3SA4	122	F 603_106.4 P90	BN90LA4	123
13.4	993	1.8	105.1	12000	F 513_105.1 S3	M3SA4	118	F 513_105.1 P90	BN90LA4	119
14.4	928	3.1	98.2	20000	F 603_98.2 S3	M3SA4	122	F 603_98.2 P90	BN90LA4	123
16.6	802	1.4	84.9	8500	F 413_84.9 S3	M3SA4	114	F 413_84.9 P90	BN90LA4	115
16.9	787	2.3	83.2	12000	F 513_83.2 S3	M3SA4	118	F 513_83.2 P90	BN90LA4	119
20.4	653	0.9	69.1	6500	F 313_69.1 S3	M3SA4	110	F 313_69.1 P90	BN90LA4	111
21.2	629	1.7	66.5	8500	F 413_66.5 S3	M3SA4	114	F 413_66.5 P90	BN90LA4	115
21.4	622	2.9	65.8	12000	F 513_65.8 S3	M3SA4	118	F 513_65.8 P90	BN90LA4	119
22.5	593	1.0	62.8	6500	F 313_62.8 S3	M3SA4	110	F 313_62.8 P90	BN90LA4	111
23.4	570	1.9	60.2	8500	F 413_60.2 S3	M3SA4	114	F 413_60.2 P90	BN90LA4	115
27.1	492	1.2	52.1	6500	F 313_52.1 S3	M3SA4	110	F 313_52.1 P90	BN90LA4	111
27.4	487	2.2	51.5	8500	F 413_51.5 S3	M3SA4	114	F 413_51.5 P90	BN90LA4	115
29.4	463	2.3	47.9	8500	F 412_47.9 S3	M3SA4	114	F 412_47.9 P90	BN90LA4	115
29.7	449	1.3	47.5	6500	F 313_47.5 S3	M3SA4	110	F 313_47.5 P90	BN90LA4	111
31	431	0.9	45.6	3880	F 253_45.6 S3	M3SA4	106	F 253_45.6 P90	BN90LA4	107
32	431	1.4	44.6	6500	F 312_44.6 S3	M3SA4	110	F 312_44.6 P90	BN90LA4	111
35	393	1.0	40.7	3970	F 252_40.7 S3	M3SA4	106	F 252_40.7 P90	BN90LA4	107
35	390	1.5	40.4	6500	F 312_40.4 S3	M3SA4	110	F 312_40.4 P90	BN90LA4	111
37	364	1.6	37.7	6500	F 312_37.7 S3	M3SA4	110	F 312_37.7 P90	BN90LA4	111
37	369	3.0	38.2	8500	F 412_38.2 S3	M3SA4	114	F 412_38.2 P90	BN90LA4	115
39	352	1.1	36.4	3940	F 252_36.4 S3	M3SA4	106	F 252_36.4 P90	BN90LA4	107
41	332	1.8	34.4	6500	F 312_34.4 S3	M3SA4	110	F 312_34.4 P90	BN90LA4	111
44	311	1.3	32.2	3890	F 252_32.2 S3	M3SA4	106	F 252_32.2 P90	BN90LA4	107
47	290	1.4	30.0	3860	F 252_30.0 S3	M3SA4	106	F 252_30.0 P90	BN90LA4	107
47	291	2.1	30.1	6500	F 312_30.1 S3	M3SA4	110	F 312_30.1 P90	BN90LA4	111
52	263	1.5	27.2	3810	F 252_27.2 S3	M3SA4	106	F 252_27.2 P90	BN90LA4	107
52	263	2.3	27.3	6500	F 312_27.3 S3	M3SA4	110	F 312_27.3 P90	BN90LA4	111
54	250	1.0	25.9	2640	F 202_25.9 S3	M3SA4	102	F 202_25.9 P90	BN90LA4	103
59	229	1.7	23.8	3730	F 252_23.8 S3	M3SA4	106	F 252_23.8 P90	BN90LA4	107

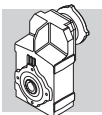

1.5 КВТ

n_2 мин-1	M_2 Нм	S	i	R_{n2} Н					
60	226	2.7	23.4	6480	F 312_23.4 S3 M3SA4	110	F 312_23.4 P90	BN90LA4	111
61	224	1.1	23.1	2600	F 202_23.1 S3 M3SA4	102	F 202_23.1 P90	BN90LA4	103
65	211	1.9	21.8	3680	F 252_21.8 S3 M3SA4	106	F 252_21.8 P90	BN90LA4	107
67	204	2.9	21.1	6320	F 312_21.1 S3 M3SA4	110	F 312_21.1 P90	BN90LA4	111
70	195	1.1	20.2	2530	F 202_20.2 S3 M3SA4	102	F 202_20.2 P90	BN90LA4	103
76	180	2.2	18.6	3570	F 252_18.6 S3 M3SA4	106	F 252_18.6 P90	BN90LA4	107
76	179	3.4	18.5	6110	F 312_18.5 S3 M3SA4	110	F 312_18.5 P90	BN90LA4	111
78	175	1.2	18.1	2480	F 202_18.1 S3 M3SA4	102	F 202_18.1 P90	BN90LA4	103
85	161	2.5	16.6	3490	F 252_16.6 S3 M3SA4	106	F 252_16.6 P90	BN90LA4	107
95	143	1.4	14.8	2380	F 202_14.8 S3 M3SA4	102	F 202_14.8 P90	BN90LA4	103
97	140	2.9	14.5	3390	F 252_14.5 S3 M3SA4	106	F 252_14.5 P90	BN90LA4	107
109	125	3.2	13.0	3310	F 252_13.0 S3 M3SA4	106	F 252_13.0 P90	BN90LA4	107
126	108	1.6	11.2	2220	F 202_11.2 S3 M3SA4	102	F 202_11.2 P90	BN90LA4	103
144	94	0.9	9.8	1760	F 102_9.8 S3 M3SA4	98	F 102_9.8 P90	BN90LA4	99
151	90	2.9	9.4	3070	F 252_9.4 S3 M3SA4	106	F 252_9.4 P90	BN90LA4	107
161	84	1.8	8.7	2090	F 202_8.7 S3 M3SA4	102	F 202_8.7 P90	BN90LA4	103
164	83	1.0	8.6	1710	F 102_8.6 S3 M3SA4	98	F 102_8.6 P90	BN90LA4	99
168	81	3.2	8.4	2980	F 252_8.4 S3 M3SA4	106	F 252_8.4 P90	BN90LA4	107
180	76	1.9	7.8	2030	F 202_7.8 S3 M3SA4	102	F 202_7.8 P90	BN90LA4	103
190	72	1.1	7.4	1650	F 102_7.4 S3 M3SA4	98	F 102_7.4 P90	BN90LA4	99
220	62	2.1	6.4	1930	F 202_6.4 S3 M3SA4	102	F 202_6.4 P90	BN90LA4	103
243	56	1.4	11.5	1560	F 102_11.5 S2 M2SB2	98	F 102_11.5 P90	BN90SA2	99
249	55	2.6	11.2	1860	F 202_11.2 S2 M2SB2	102	F 202_11.2 P90	BN90SA2	103
287	48	1.5	9.8	1490	F 102_9.8 S2 M2SB2	98	F 102_9.8 P90	BN90SA2	99
321	42	2.9	8.7	1740	F 202_8.7 S2 M2SB2	102	F 202_8.7 P90	BN90SA2	103
326	42	1.6	8.6	1440	F 102_8.6 S2 M2SB2	98	F 102_8.6 P90	BN90SA2	99
357	38	3.0	7.8	1680	F 202_7.8 S2 M2SB2	102	F 202_7.8 P90	BN90SA2	103
378	36	1.7	7.4	1380	F 102_7.4 S2 M2SB2	98	F 102_7.4 P90	BN90SA2	99
437	31	3.3	6.4	1590	F 202_6.4 S2 M2SB2	102	F 202_6.4 P90	BN90SA2	103

2.2 КВТ

n_2 мин-1	M_2 Нм	S	i	R_{n2} Н					
1.2	16347	0.9	1205	55000	F 904_1205 S3 M3LA4	132	F 904_1205 P100	BN100LA4	133
1.3	15090	0.9	1112	55000	F 904_1112 S3 M3LA4	132	F 904_1112 P100	BN100LA4	133
1.5	12348	1.1	910.2	55000	F 904_910.2 S3 M3LA4	132	F 904_910.2 P100	BN100LA4	133
1.8	10493	1.3	773.4	55000	F 904_773.4 S3 M3LA4	132	F 904_773.4 P100	BN100LA4	133
2.3	8287	1.0	610.9	45000	F 804_610.9 S3 M3LA4	129	F 804_610.9 P100	BN100LA4	130
2.3	8488	1.6	625.6	55000	F 904_625.6 S3 M3LA4	132	F 904_625.6 P100	BN100LA4	133
2.4	7835	1.8	577.5	55000	F 904_577.5 S3 M3LA4	132	F 904_577.5 P100	BN100LA4	133
2.5	7650	1.0	563.9	45000	F 804_563.9 S3 M3LA4	129	F 804_563.9 P100	BN100LA4	130
2.8	6723	2.1	495.6	55000	F 904_495.6 S3 M3LA4	132	F 904_495.6 P100	BN100LA4	133
2.9	6636	1.2	489.1	45000	F 804_489.1 S3 M3LA4	129	F 804_489.1 P100	BN100LA4	130
3.1	6125	1.3	451.5	45000	F 804_451.5 S3 M3LA4	129	F 804_451.5 P100	BN100LA4	130
3.1	6206	2.3	457.5	55000	F 904_457.5 S3 M3LA4	132	F 904_457.5 P100	BN100LA4	133
3.5	5474	0.9	403.5	35000	F 704_403.5 S3 M3LA4	126	F 704_403.5 P100	BN100LA4	127
3.7	5198	1.5	383.2	45000	F 804_383.2 S3 M3LA4	129	F 804_383.2 P100	BN100LA4	130
3.8	5053	1.0	372.5	35000	F 704_372.5 S3 M3LA4	126	F 704_372.5 P100	BN100LA4	127
3.9	4909	2.9	361.8	55000	F 904_361.8 S3 M3LA4	132	F 904_361.8 P100	BN100LA4	133
4.0	4798	1.7	353.7	45000	F 804_353.7 S3 M3LA4	129	F 804_353.7 P100	BN100LA4	130
4.6	4129	1.2	304.3	35000	F 704_304.3 S3 M3LA4	126	F 704_304.3 P100	BN100LA4	127
4.8	4025	2.0	296.7	45000	F 804_296.7 S3 M3LA4	129	F 804_296.7 P100	BN100LA4	130
4.8	3950	3.5	291.1	55000	F 904_291.1 S3 M3LA4	132	F 904_291.1 P100	BN100LA4	133
5.0	3811	1.3	280.9	35000	F 704_280.9 S3 M3LA4	126	F 704_280.9 P100	BN100LA4	127
5.1	3716	2.2	273.9	45000	F 804_273.9 S3 M3LA4	129	F 804_273.9 P100	BN100LA4	130
6.0	3182	1.6	234.6	35000	F 704_234.6 S3 M3LA4	126	F 704_234.6 P100	BN100LA4	127
6.5	3018	1.0	217.6	20000	F 603_217.6 S3 M3LA4	122	F 603_217.6 P100	BN100LA4	123
6.5	2938	1.7	216.5	35000	F 704_216.5 S3 M3LA4	126	F 704_216.5 P100	BN100LA4	127

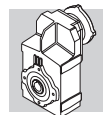

2.2 КВТ

n ₂ МИН-1	M ₂ Нм	S	i	R _{n2} Н								
6.5	2964	2.7	218.5	45000	F 804_218.5	S3	M3LA4	129	F 804_218.5	P100	BN100LA4	130
7.0	2792	1.0	201.4	20000	F 603_201.4	S3	M3LA4	122	F 603_201.4	P100	BN100LA4	123
7.2	2718	1.8	196.0	35000	F 703_196.0	S3	M3LA4	126	F 703_196.0	P100	BN100LA4	127
7.6	2577	1.1	185.9	20000	F 603_185.9	S3	M3LA4	122	F 603_185.9	P100	BN100LA4	123
7.6	2560	3.1	184.6	45000					F 803_184.6	P100	BN100LA4	130
7.8	2509	2.0	180.9	35000	F 703_180.9	S3	M3LA4	126	F 703_180.9	P100	BN100LA4	127
8.5	2311	2.2	166.7	35000	F 703_166.7	S3	M3LA4	126	F 703_166.7	P100	BN100LA4	127
8.7	2258	1.3	162.9	20000	F 603_162.9	S3	M3LA4	122	F 603_162.9	P100	BN100LA4	123
9.2	2133	2.3	153.8	35000	F 703_153.8	S3	M3LA4	126	F 703_153.8	P100	BN100LA4	127
9.4	2085	1.4	150.4	20000	F 603_150.4	S3	M3LA4	122	F 603_150.4	P100	BN100LA4	123
10.6	1843	2.7	133.0	35000	F 703_133.0	S3	M3LA4	126	F 703_133.0	P100	BN100LA4	127
10.8	1809	1.6	130.5	20000	F 603_130.5	S3	M3LA4	122	F 603_130.5	P100	BN100LA4	123
10.9	1801	1.0	129.9	12000	F 513_129.9	S3	M3LA4	118	F 513_129.9	P100	BN100LA4	119
11.5	1702	2.9	122.7	35000	F 703_122.7	S3	M3LA4	126	F 703_122.7	P100	BN100LA4	127
11.7	1670	1.7	120.5	20000	F 603_120.5	S3	M3LA4	122	F 603_120.5	P100	BN100LA4	123
12.9	1520	3.3	109.6	35000	F 703_109.6	S3	M3LA4	126	F 703_109.6	P100	BN100LA4	127
13.3	1475	2.0	106.4	20000	F 603_106.4	S3	M3LA4	122	F 603_106.4	P100	BN100LA4	123
13.4	1457	1.2	105.1	12000	F 513_105.1	S3	M3LA4	118	F 513_105.1	P100	BN100LA4	119
14.4	1362	2.1	98.2	20000	F 603_98.2	S3	M3LA4	122	F 603_98.2	P100	BN100LA4	123
16.6	1177	0.9	84.9	8500	F 413_84.9	S3	M3LA4	114	F 413_84.9	P100	BN100LA4	115
16.8	1165	2.5	84.0	20000	F 603_84.0	S3	M3LA4	122	F 603_84.0	P100	BN100LA4	123
16.9	1154	1.6	83.2	12000	F 513_83.2	S3	M3LA4	118	F 513_83.2	P100	BN100LA4	119
18.2	1075	2.7	77.6	20000	F 603_77.6	S3	M3LA4	122	F 603_77.6	P100	BN100LA4	123
20.7	947	3.1	68.3	20000	F 603_68.3	S3	M3LA4	122	F 603_68.3	P100	BN100LA4	123
21.2	922	1.2	66.5	8500	F 413_66.5	S3	M3LA4	114	F 413_66.5	P100	BN100LA4	115
21.4	913	2.0	65.8	12000	F 513_65.8	S3	M3LA4	118	F 513_65.8	P100	BN100LA4	119
22.4	874	3.3	63.0	20000	F 603_63.0	S3	M3LA4	122	F 603_63.0	P100	BN100LA4	123
23.4	835	1.3	60.2	8500	F 413_60.2	S3	M3LA4	114	F 413_60.2	P100	BN100LA4	115
27.4	714	1.5	51.5	8500	F 413_51.5	S3	M3LA4	114	F 413_51.5	P100	BN100LA4	115
28.8	678	2.7	48.9	12000	F 513_48.9	S3	M3LA4	118	F 513_48.9	P100	BN100LA4	119
29.4	679	1.6	47.9	8500	F 412_47.9	S3	M3LA4	114	F 412_47.9	P100	BN100LA4	115
32	632	0.9	44.6	6500	F 312_44.6	S3	M3LA4	110	F 312_44.6	P100	BN100LA4	111
35	572	1.0	40.4	6500	F 312_40.4	S3	M3LA4	110	F 312_40.4	P100	BN100LA4	111
37	534	1.1	37.7	6500	F 312_37.7	S3	M3LA4	110	F 312_37.7	P100	BN100LA4	111
37	541	2.0	38.2	8500	F 412_38.2	S3	M3LA4	114	F 412_38.2	P100	BN100LA4	115
38	526	3.2	37.1	12000	F 512_37.1	S3	M3LA4	118	F 512_37.1	P100	BN100LA4	119
41	487	1.2	34.4	6490	F 312_34.4	S3	M3LA4	110	F 312_34.4	P100	BN100LA4	111
47	425	0.9	30.0	3300	F 252_30.0	S3	M3LA4	106	F 252_30.0	P100	BN100LA4	107
47	427	1.4	30.1	6360	F 312_30.1	S3	M3LA4	110	F 312_30.1	P100	BN100LA4	111
47	427	2.6	30.1	8500	F 412_30.1	S3	M3LA4	114	F 412_30.1	P100	BN100LA4	115
52	385	1.0	27.2	3300	F 252_27.2	S3	M3LA4	106	F 252_27.2	P100	BN100LA4	107
52	386	1.6	27.3	6250	F 312_27.3	S3	M3LA4	110	F 312_27.3	P100	BN100LA4	111
58	342	3.2	24.1	8400	F 412_24.1	S3	M3LA4	114	F 412_24.1	P100	BN100LA4	115
59	336	1.2	23.8	3290	F 252_23.8	S3	M3LA4	106	F 252_23.8	P100	BN100LA4	107
60	331	1.8	23.4	6080	F 312_23.4	S3	M3LA4	110	F 312_23.4	P100	BN100LA4	111
65	309	1.3	21.8	3270	F 252_21.8	S3	M3LA4	106	F 252_21.8	P100	BN100LA4	107
67	299	2.0	21.1	5960	F 312_21.1	S3	M3LA4	110	F 312_21.1	P100	BN100LA4	111
76	264	1.5	18.6	3220	F 252_18.6	S3	M3LA4	106	F 252_18.6	P100	BN100LA4	107
76	262	2.3	18.5	5790	F 312_18.5	S3	M3LA4	110	F 312_18.5	P100	BN100LA4	111
84	238	2.5	16.8	5670	F 312_16.8	S3	M3LA4	110	F 312_16.8	P100	BN100LA4	111
85	235	1.7	16.6	3180	F 252_16.6	S3	M3LA4	106	F 252_16.6	P100	BN100LA4	107
95	210	1.0	14.8	2190	F 202_14.8	S3	M3LA4	102	F 202_14.8	P100	BN100LA4	103
97	205	2.0	14.5	3120	F 252_14.5	S3	M3LA4	106	F 252_14.5	P100	BN100LA4	107
101	198	3.0	13.9	5430	F 312_13.9	S3	M3LA4	110	F 312_13.9	P100	BN100LA4	111
109	184	2.2	13.0	3070	F 252_13.0	S3	M3LA4	106	F 252_13.0	P100	BN100LA4	107
111	180	3.3	12.7	5310	F 312_12.7	S3	M3LA4	110	F 312_12.7	P100	BN100LA4	111
126	159	1.1	11.2	2060	F 202_11.2	S3	M3LA4	102	F 202_11.2	P100	BN100LA4	103
133	150	2.6	10.6	2960	F 252_10.6	S3	M3LA4	106	F 252_10.6	P100	BN100LA4	107
151	133	2.0	9.4	2900	F 252_9.4	S3	M3LA4	106	F 252_9.4	P100	BN100LA4	107
156	128	3.1	9.0	4830	F 312_9.0	S3	M3LA4	110	F 312_9.0	P100	BN100LA4	111
161	124	1.3	8.7	1960	F 202_8.7	S3	M3LA4	102	F 202_8.7	P100	BN100LA4	103

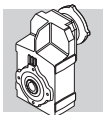

2.2 КВТ



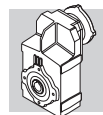

n ₂ МИН-1	M ₂ НМ	S	i	R _{n2} Н				
168	119	2.2	8.4	2830	F 252_8.4 S3 M3LA4	106	F 252_8.4 P100 BN100LA4	107
171	117	3.3	8.2	4720	F 312_8.2 S3 M3LA4	110	F 312_8.2 P100 BN100LA4	111
180	111	1.3	7.8	1920	F 202_7.8 S3 M3LA4	102	F 202_7.8 P100 BN100LA4	103
205	97	2.6	6.9	2710	F 252_6.9 S3 M3LA4	106	F 252_6.9 P100 BN100LA4	107
220	91	1.4	6.4	1840	F 202_6.4 S3 M3LA4	102	F 202_6.4 P100 BN100LA4	103
247	81	1.0	11.5	1470	F 102_11.5 S3 M3SA2	98	F 102_11.5 P90 BN90L2	99
254	79	1.8	11.2	1780	F 202_11.2 S3 M3SA2	102	F 202_11.2 P90 BN90L2	103
292	68	1.1	9.8	1410	F 102_9.8 S3 M3SA2	98	F 102_9.8 P90 BN90L2	99
326	61	2.0	8.7	1670	F 202_8.7 S3 M3SA2	102	F 202_8.7 P90 BN90L2	103
332	60	1.1	8.6	1370	F 102_8.6 S3 M3SA2	98	F 102_8.6 P90 BN90L2	99
364	55	2.1	7.8	1630	F 202_7.8 S3 M3SA2	102	F 202_7.8 P90 BN90L2	103
385	52	1.2	7.4	1330	F 102_7.4 S3 M3SA2	98	F 102_7.4 P90 BN90L2	99
444	45	2.3	6.4	1540	F 202_6.4 S3 M3SA2	102	F 202_6.4 P90 BN90L2	103

3 КВТ

n ₂ МИН-1	M ₂ НМ	S	i	R _{n2} Н				
1.8	14309	1.0	773.4	55000	F 904_773.4 S3 M3LB4	132	F 904_773.4 P100 BN100LB4	133
2.3	11574	1.2	625.6	55000	F 904_625.6 S3 M3LB4	132	F 904_625.6 P100 BN100LB4	133
2.4	10684	1.3	577.5	55000	F 904_577.5 S3 M3LB4	132	F 904_577.5 P100 BN100LB4	133
2.8	9168	1.5	495.6	55000	F 904_495.6 S3 M3LB4	132	F 904_495.6 P100 BN100LB4	133
2.9	9049	0.9	489.1	45000	F 804_489.1 S3 M3LB4	129	F 804_489.1 P100 BN100LB4	130
3.1	8353	1.0	451.5	45000	F 804_451.5 S3 M3LB4	129	F 804_451.5 P100 BN100LB4	130
3.1	8463	1.7	457.5	55000	F 904_457.5 S3 M3LB4	132	F 904_457.5 P100 BN100LB4	133
3.7	7088	1.1	383.2	45000	F 804_383.2 S3 M3LB4	129	F 804_383.2 P100 BN100LB4	130
3.9	6694	2.1	361.8	55000	F 904_361.8 S3 M3LB4	132	F 904_361.8 P100 BN100LB4	133
4.0	6543	1.2	353.7	45000	F 804_353.7 S3 M3LB4	129	F 804_353.7 P100 BN100LB4	130
4.6	5630	0.9	304.3	35000	F 704_304.3 S3 M3LB4	126	F 704_304.3 P100 BN100LB4	127
4.8	5489	1.5	296.7	45000	F 804_296.7 S3 M3LB4	129	F 804_296.7 P100 BN100LB4	130
4.8	5386	2.6	291.1	55000	F 904_291.1 S3 M3LB4	132	F 904_291.1 P100 BN100LB4	133
5.0	5197	1.0	280.9	35000	F 704_280.9 S3 M3LB4	126	F 704_280.9 P100 BN100LB4	127
5.1	5067	1.6	273.9	45000	F 804_273.9 S3 M3LB4	129	F 804_273.9 P100 BN100LB4	130
5.2	4971	2.8	268.7	55000	F 904_268.7 S3 M3LB4	132	F 904_268.7 P100 BN100LB4	133
6.0	4340	1.2	234.6	35000	F 704_234.6 S3 M3LB4	126	F 704_234.6 P100 BN100LB4	127
6.1	4281	3.3	231.4	55000	F 904_231.4 S3 M3LB4	132	F 904_231.4 P100 BN100LB4	133
6.5	4006	1.2	216.5	35000	F 704_216.5 S3 M3LB4	126	F 704_216.5 P100 BN100LB4	127
6.5	4042	2.0	218.5	45000	F 804_218.5 S3 M3LB4	129	F 804_218.5 P100 BN100LB4	130
6.6	3951	3.5	213.6	55000	F 904_213.6 S3 M3LB4	132	F 904_213.6 P100 BN100LB4	133
7.2	3706	1.3	196.0	35000	F 703_196.0 S3 M3LB4	126	F 703_196.0 P100 BN100LB4	127
7.6	3490	2.3	184.6	45000	F 803_184.6 P100 BN100LB4		F 803_184.6 P100 BN100LB4	130
7.8	3421	1.5	180.9	35000	F 703_180.9 S3 M3LB4	126	F 703_180.9 P100 BN100LB4	127
8.5	3151	1.6	166.7	35000	F 703_166.7 S3 M3LB4	126	F 703_166.7 P100 BN100LB4	127
8.7	3080	0.9	162.9	20000	F 603_162.9 S3 M3LB4	122	F 603_162.9 P100 BN100LB4	123
8.8	3029	2.6	160.2	45000	F 803_160.2 P100 BN100LB4		F 803_160.2 P100 BN100LB4	130
9.2	2909	1.7	153.8	35000	F 703_153.8 S3 M3LB4	126	F 703_153.8 P100 BN100LB4	127
9.4	2843	1.0	150.4	20000	F 603_150.4 S3 M3LB4	122	F 603_150.4 P100 BN100LB4	123
9.5	2796	2.9	147.9	45000	F 803_147.9 P100 BN100LB4		F 803_147.9 P100 BN100LB4	130
10.6	2514	2.0	133.0	35000	F 703_133.0 S3 M3LB4	126	F 703_133.0 P100 BN100LB4	127
10.6	2509	3.2	132.7	45000	F 803_132.7 P100 BN100LB4		F 803_132.7 P100 BN100LB4	130
10.8	2467	1.2	130.5	20000	F 603_130.5 S3 M3LB4	122	F 603_130.5 P100 BN100LB4	123
11.5	2320	2.2	122.7	35000	F 703_122.7 S3 M3LB4	126	F 703_122.7 P100 BN100LB4	127
11.5	2316	3.5	122.5	45000	F 803_122.5 P100 BN100LB4		F 803_122.5 P100 BN100LB4	130
11.7	2277	1.3	120.5	20000	F 603_120.5 S3 M3LB4	122	F 603_120.5 P100 BN100LB4	123
12.9	2072	2.4	109.6	35000	F 703_109.6 S3 M3LB4	126	F 703_109.6 P100 BN100LB4	127
13.3	2011	1.4	106.4	20000	F 603_106.4 S3 M3LB4	122	F 603_106.4 P100 BN100LB4	123
13.4	1987	0.9	105.1	12000	F 513_105.1 S3 M3LB4	118	F 513_105.1 P100 BN100LB4	119
13.9	1913	2.6	101.2	35000	F 703_101.2 S3 M3LB4	126	F 703_101.2 P100 BN100LB4	127

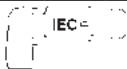

3 КВТ

n ₂ МИН-1	M ₂ Нм	S	i	R _{n2} Н				
14.4	1857	1.6	98.2	20000	F 603_98.2 S3 M3LB4	122	F 603_98.2 P100 BN100LB4	123
15.2	1749	2.9	92.5	35000	F 703_92.5 S3 M3LB4	126	F 703_92.5 P100 BN100LB4	127
16.5	1614	3.1	85.4	35000	F 703_85.4 S3 M3LB4	126	F 703_85.4 P100 BN100LB4	127
16.8	1588	1.8	84.0	20000	F 603_84.0 S3 M3LB4	122	F 603_84.0 P100 BN100LB4	123
16.9	1574	1.1	83.2	12000	F 513_83.2 S3 M3LB4	118	F 513_83.2 P100 BN100LB4	119
18.2	1466	2.0	77.6	20000	F 603_77.6 S3 M3LB4	122	F 603_77.6 P100 BN100LB4	123
20.7	1291	2.2	68.3	20000	F 603_68.3 S3 M3LB4	122	F 603_68.3 P100 BN100LB4	123
21.4	1245	1.4	65.8	12000	F 513_65.8 S3 M3LB4	118	F 513_65.8 P100 BN100LB4	119
22.4	1192	2.4	63.0	20000	F 603_63.0 S3 M3LB4	122	F 603_63.0 P100 BN100LB4	123
23.4	1139	1.0	60.2	8500	F 413_60.2 S3 M3LB4	114	F 413_60.2 P100 BN100LB4	115
27.2	980	3.0	51.8	20000	F 603_51.8 S3 M3LB4	122	F 603_51.8 P100 BN100LB4	123
27.4	974	1.1	51.5	8500	F 413_51.5 S3 M3LB4	114	F 413_51.5 P100 BN100LB4	115
28.8	925	1.9	48.9	12000	F 513_48.9 S3 M3LB4	118	F 513_48.9 P100 BN100LB4	119
29.4	926	1.2	47.9	8500	F 412_47.9 S3 M3LB4	114	F 412_47.9 P100 BN100LB4	115
29.5	905	3.2	47.8	20000	F 603_47.8 S3 M3LB4	122	F 603_47.8 P100 BN100LB4	123
37	737	1.5	38.2	8500	F 412_38.2 S3 M3LB4	114	F 412_38.2 P100 BN100LB4	115
38	717	2.4	37.1	11800	F 512_37.1 S3 M3LB4	118	F 512_37.1 P100 BN100LB4	119
41	664	0.9	34.4	5810	F 312_34.4 S3 M3LB4	110	F 312_34.4 P100 BN100LB4	111
47	582	1.0	30.1	5770	F 312_30.1 S3 M3LB4	110	F 312_30.1 P100 BN100LB4	111
47	582	1.9	30.1	8290	F 412_30.1 S3 M3LB4	114	F 412_30.1 P100 BN100LB4	115
47	580	2.9	30.0	11200	F 512_30.0 S3 M3LB4	118	F 512_30.0 P100 BN100LB4	119
52	527	1.1	27.3	5720	F 312_27.3 S3 M3LB4	110	F 312_27.3 P100 BN100LB4	111
58	466	2.4	24.1	7960	F 412_24.1 S3 M3LB4	114	F 412_24.1 P100 BN100LB4	115
60	452	1.3	23.4	5620	F 312_23.4 S3 M3LB4	110	F 312_23.4 P100 BN100LB4	111
65	421	0.9	21.8	2800	F 252_21.8 S3 M3LB4	106	F 252_21.8 P100 BN100LB4	107
67	408	1.5	21.1	5540	F 312_21.1 S3 M3LB4	110	F 312_21.1 P100 BN100LB4	111
75	365	3.0	18.9	7560	F 412_18.9 S3 M3LB4	114	F 412_18.9 P100 BN100LB4	115
76	359	1.1	18.6	2830	F 252_18.6 S3 M3LB4	106	F 252_18.6 P100 BN100LB4	107
76	357	1.7	18.5	5430	F 312_18.5 S3 M3LB4	110	F 312_18.5 P100 BN100LB4	111
82	331	3.2	17.1	7400	F 412_17.1 S3 M3LB4	114	F 412_17.1 P100 BN100LB4	115
84	324	1.8	16.8	5340	F 312_16.8 S3 M3LB4	110	F 312_16.8 P100 BN100LB4	111
85	321	1.2	16.6	2830	F 252_16.6 S3 M3LB4	106	F 252_16.6 P100 BN100LB4	107
97	279	1.4	14.5	2810	F 252_14.5 S3 M3LB4	106	F 252_14.5 P100 BN100LB4	107
101	269	2.2	13.9	5150	F 312_13.9 S3 M3LB4	110	F 312_13.9 P100 BN100LB4	111
109	251	1.6	13.0	2790	F 252_13.0 S3 M3LB4	106	F 252_13.0 P100 BN100LB4	107
111	246	2.4	12.7	5060	F 312_12.7 S3 M3LB4	110	F 312_12.7 P100 BN100LB4	111
131	208	2.9	10.7	4880	F 312_10.7 S3 M3LB4	110	F 312_10.7 P100 BN100LB4	111
133	205	1.9	10.6	2730	F 252_10.6 S3 M3LB4	106	F 252_10.6 P100 BN100LB4	107
151	181	1.5	9.4	2710	F 252_9.4 S3 M3LB4	106	F 252_9.4 P100 BN100LB4	107
156	174	2.2	9.0	4650	F 312_9.0 S3 M3LB4	110	F 312_9.0 P100 BN100LB4	111
161	169	0.9	8.7	1820	F 202_8.7 S3 M3LB4	102	F 202_8.7 P100 BN100LB4	103
168	162	1.6	8.4	2660	F 252_8.4 S3 M3LB4	106	F 252_8.4 P100 BN100LB4	107
171	159	2.5	8.2	4550	F 312_8.2 S3 M3LB4	110	F 312_8.2 P100 BN100LB4	111
180	151	1.0	7.8	1790	F 202_7.8 S3 M3LB4	102	F 202_7.8 P100 BN100LB4	103
203	134	2.9	6.9	4360	F 312_6.9 S3 M3LB4	110	F 312_6.9 P100 BN100LB4	111
205	133	1.9	6.9	2560	F 252_6.9 S3 M3LB4	106	F 252_6.9 P100 BN100LB4	107
220	124	1.0	6.4	1730	F 202_6.4 S3 M3LB4	102	F 202_6.4 P100 BN100LB4	103
220	124	2.9	13.0	2510	F 252_13.0 S3 M3LA2	106	F 252_13.0 P100 BN100L2	107
255	107	1.3	11.2	1680	F 202_11.2 S3 M3LA2	102	F 202_11.2 P100 BN100L2	103
269	101	3.2	10.6	2410	F 252_10.6 S3 M3LA2	106	F 252_10.6 P100 BN100L2	107
306	89	3.0	9.4	2350	F 252_9.4 S3 M3LA2	106	F 252_9.4 P100 BN100L2	107
328	83	1.5	8.7	1600	F 202_8.7 S3 M3LA2	102	F 202_8.7 P100 BN100L2	103
341	80	3.3	8.4	2290	F 252_8.4 S3 M3LA2	106	F 252_8.4 P100 BN100L2	107
365	75	1.5	7.8	1560	F 202_7.8 S3 M3LA2	102	F 202_7.8 P100 BN100L2	103
446	61	1.7	6.4	1480	F 202_6.4 S3 M3LA2	102	F 202_6.4 P100 BN100L2	103

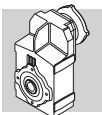

4 KBT

n ₂ MIN-1	M ₂ Hm	S	i	R _{n2} H								
2.2	15542	0.9	625.6	55000	F 904_625.6	S3	M3LC4	132	F 904_625.6	P112	BN112M4	133
2.4	14347	1.0	577.5	55000	F 904_577.5	S3	M3LC4	132	F 904_577.5	P112	BN112M4	133
2.8	12311	1.1	495.6	55000	F 904_495.6	S3	M3LC4	132	F 904_495.6	P112	BN112M4	133
3.1	11364	1.2	457.5	55000	F 904_457.5	S3	M3LC4	132	F 904_457.5	P112	BN112M4	133
3.9	8989	1.6	361.8	55000	F 904_361.8	S3	M3LC4	132	F 904_361.8	P112	BN112M4	133
4.0	8786	0.9	353.7	45000	F 804_353.7	S3	M3LC4	129	F 804_353.7	P112	BN112M4	130
4.7	7371	1.1	296.7	45000	F 804_296.7	S3	M3LC4	129	F 804_296.7	P112	BN112M4	130
4.8	7232	1.9	291.1	55000	F 904_291.1	S3	M3LC4	132	F 904_291.1	P112	BN112M4	133
5.1	6804	1.2	273.9	45000	F 804_273.9	S3	M3LC4	129	F 804_273.9	P112	BN112M4	130
5.2	6676	2.1	268.7	55000	F 904_268.7	S3	M3LC4	132	F 904_268.7	P112	BN112M4	133
6.0	5827	0.9	234.6	35000	F 704_234.6	S3	M3LC4	126	F 704_234.6	P112	BN112M4	127
6.1	5748	2.4	231.4	55000	F 904_231.4	S3	M3LC4	132	F 904_231.4	P112	BN112M4	133
6.4	5428	1.5	218.5	45000	F 804_218.5	S3	M3LC4	129	F 804_218.5	P112	BN112M4	130
6.5	5379	0.9	216.5	35000	F 704_216.5	S3	M3LC4	126	F 704_216.5	P112	BN112M4	127
6.6	5306	2.6	213.6	55000	F 904_213.6	S3	M3LC4	132	F 904_213.6	P112	BN112M4	133
7.1	4977	1.0	196.0	35000	F 703_196.0	S3	M3LC4	126	F 703_196.0	P112	BN112M4	127
7.2	4929	2.8	194.2	55000					F 903_194.2	P112	BN112M4	133
7.6	4687	1.7	184.6	45000					F 803_184.6	P112	BN112M4	130
7.7	4594	1.1	180.9	35000	F 703_180.9	S3	M3LC4	126	F 703_180.9	P112	BN112M4	127
7.8	4550	3.1	179.2	55000					F 903_179.2	P112	BN112M4	133
8.4	4232	1.2	166.7	35000	F 703_166.7	S3	M3LC4	126	F 703_166.7	P112	BN112M4	127
8.6	4134	3.4	162.8	55000					F 903_162.8	P112	BN112M4	133
8.7	4068	2.0	160.2	45000					F 803_160.2	P112	BN112M4	130
9.1	3906	1.3	153.8	35000	F 703_153.8	S3	M3LC4	126	F 703_153.8	P112	BN112M4	127
9.5	3755	2.1	147.9	45000					F 803_147.9	P112	BN112M4	130
10.5	3376	1.5	133.0	35000	F 703_133.0	S3	M3LC4	126	F 703_133.0	P112	BN112M4	127
10.6	3369	2.4	132.7	45000					F 803_132.7	P112	BN112M4	130
11.4	3116	1.6	122.7	35000	F 703_122.7	S3	M3LC4	126	F 703_122.7	P112	BN112M4	127
11.4	3110	2.6	122.5	45000					F 803_122.5	P112	BN112M4	130
11.6	3058	0.9	120.5	20000	F 603_120.5	S3	M3LC4	122	F 603_120.5	P112	BN112M4	123
12.3	2888	2.8	113.8	45000					F 803_113.8	P112	BN112M4	130
12.8	2783	1.8	109.6	35000	F 703_109.6	S3	M3LC4	126	F 703_109.6	P112	BN112M4	127
13.2	2701	1.1	106.4	20000	F 603_106.4	S3	M3LC4	122	F 603_106.4	P112	BN112M4	123
13.8	2569	1.9	101.2	35000	F 703_101.2	S3	M3LC4	126	F 703_101.2	P112	BN112M4	127
14.3	2493	1.2	98.2	20000	F 603_98.2	S3	M3LC4	122	F 603_98.2	P112	BN112M4	123
15.1	2348	2.1	92.5	35000	F 703_92.5	S3	M3LC4	126	F 703_92.5	P112	BN112M4	127
16.4	2168	2.3	85.4	35000	F 703_85.4	S3	M3LC4	126	F 703_85.4	P112	BN112M4	127
16.7	2133	1.4	84.0	20000	F 603_84.0	S3	M3LC4	122	F 603_84.0	P112	BN112M4	123
18.1	1969	1.5	77.6	20000	F 603_77.6	S3	M3LC4	122	F 603_77.6	P112	BN112M4	123
20.5	1734	1.7	68.3	20000	F 603_68.3	S3	M3LC4	122	F 603_68.3	P112	BN112M4	123
21.3	1672	1.1	65.8	12000	F 513_65.8	S3	M3LC4	118	F 513_65.8	P112	BN112M4	119
22.2	1600	1.8	63.0	20000	F 603_63.0	S3	M3LC4	122	F 603_63.0	P112	BN112M4	123
27.0	1316	2.2	51.8	20000	F 603_51.8	S3	M3LC4	122	F 603_51.8	P112	BN112M4	123
28.6	1242	1.4	48.9	11600	F 513_48.9	S3	M3LC4	118	F 513_48.9	P112	BN112M4	119
29.3	1215	2.4	47.8	20000	F 603_47.8	S3	M3LC4	122	F 603_47.8	P112	BN112M4	123
33	1069	2.7	42.1	20000	F 603_42.1	S3	M3LC4	122	F 603_42.1	P112	BN112M4	123
36	986	2.9	38.8	20000	F 603_38.8	S3	M3LC4	122	F 603_38.8	P112	BN112M4	123
37	990	1.1	38.2	7720	F 412_38.2	S3	M3LC4	114	F 412_38.2	P112	BN112M4	115
38	963	1.8	37.1	11200	F 512_37.1	S3	M3LC4	118	F 512_37.1	P112	BN112M4	119
46	781	1.4	30.1	7610	F 412_30.1	S3	M3LC4	114	F 412_30.1	P112	BN112M4	115
47	779	2.2	30.0	10700	F 512_30.0	S3	M3LC4	118	F 512_30.0	P112	BN112M4	119
55	645	2.9	25.4	20000	F 603_25.4	S3	M3LC4	122	F 603_25.4	P112	BN112M4	123
58	625	1.8	24.1	7420	F 412_24.1	S3	M3LC4	114	F 412_24.1	P112	BN112M4	115
59	617	2.7	23.8	10200	F 512_23.8	S3	M3LC4	118	F 512_23.8	P112	BN112M4	119
60	607	1.0	23.4	5040	F 312_23.4	S3	M3LC4	110	F 312_23.4	P112	BN112M4	111
60	596	3.2	23.5	20000	F 603_23.5	S3	M3LC4	122	F 603_23.5	P112	BN112M4	123
66	548	1.1	21.1	5020	F 312_21.1	S3	M3LC4	110	F 312_21.1	P112	BN112M4	111
74	490	2.2	18.9	7150	F 412_18.9	S3	M3LC4	114	F 412_18.9	P112	BN112M4	115
74	488	3.2	18.8	9640	F 512_18.8	S3	M3LC4	118	F 512_18.8	P112	BN112M4	119
76	479	1.3	18.5	4980	F 312_18.5	S3	M3LC4	110	F 312_18.5	P112	BN112M4	111
82	444	2.4	17.1	7030	F 412_17.1	S3	M3LC4	114	F 412_17.1	P112	BN112M4	115

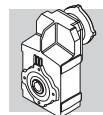

4 КВТ

n_2 мин-1	M_2 Нм	S	i	R_{n2} Н						
83	436	1.4	16.8	4930	F 312_16.8	S3	M3LC4	110	F 312_16.8 P112 BN112M4	111
84	431	0.9	16.6	2380	F 252_16.6	S3	M3LC4	106	F 252_16.6 P112 BN112M4	107
96	379	2.7	14.6	6820	F 412_14.6	S3	M3LC4	114	F 412_14.6 P112 BN112M4	115
97	375	1.1	14.5	2420	F 252_14.5	S3	M3LC4	106	F 252_14.5 P112 BN112M4	107
100	362	1.7	13.9	4820	F 312_13.9	S3	M3LC4	110	F 312_13.9 P112 BN112M4	111
108	337	1.2	13.0	2440	F 252_13.0	S3	M3LC4	106	F 252_13.0 P112 BN112M4	107
110	330	1.8	12.7	4750	F 312_12.7	S3	M3LC4	110	F 312_12.7 P112 BN112M4	111
130	279	2.2	10.7	4620	F 312_10.7	S3	M3LC4	110	F 312_10.7 P112 BN112M4	111
130	279	3.2	10.8	6380	F 412_10.8	S3	M3LC4	114	F 412_10.8 P112 BN112M4	115
132	276	1.4	10.6	2450	F 252_10.6	S3	M3LC4	106	F 252_10.6 P112 BN112M4	107
150	243	1.1	9.4	2470	F 252_9.4	S3	M3LC4	106	F 252_9.4 P112 BN112M4	107
153	237	3.0	9.1	6160	F 412_9.1	S3	M3LC4	114	F 412_9.1 P112 BN112M4	115
155	234	1.7	9.0	4420	F 312_9.0	S3	M3LC4	110	F 312_9.0 P112 BN112M4	111
167	218	1.2	8.4	2450	F 252_8.4	S3	M3LC4	106	F 252_8.4 P112 BN112M4	107
170	213	1.8	8.2	4350	F 312_8.2	S3	M3LC4	110	F 312_8.2 P112 BN112M4	111
201	180	2.2	6.9	4200	F 312_6.9	S3	M3LC4	110	F 312_6.9 P112 BN112M4	111
204	178	1.4	6.9	2390	F 252_6.9	S3	M3LC4	106	F 252_6.9 P112 BN112M4	107
206	176	3.2	13.9	4200	F 312_13.9	S3	M3LB2	110	F 312_13.9 P100 BN100LB2	111
221	164	2.2	13.0	2340	F 252_13.0	S3	M3LB2	106	F 252_13.0 P112 BN112M2	107
226	161	3.4	12.7	4120	F 312_12.7	S3	M3LB2	110	F 312_12.7 P100 BN100LB2	111
255	142	1.0	11.2	1570	F 202_11.2	S3	M3LB2	102	F 202_11.2 P100 BN100LB2	103
270	134	2.4	10.6	2270	F 252_10.6	S3	M3LB2	106	F 252_10.6 P112 BN112M2	107
307	118	2.2	9.4	2230	F 252_9.4	S3	M3LB2	106	F 252_9.4 P112 BN112M2	107
318	114	3.4	9.0	3760	F 312_9.0	S3	M3LB2	110	F 312_9.0 P100 BN100LB2	111
329	110	1.1	8.7	1510	F 202_8.7	S3	M3LB2	102	F 202_8.7 P100 BN100LB2	103
342	106	2.4	8.4	2190	F 252_8.4	S3	M3LB2	106	F 252_8.4 P112 BN112M2	107
366	99	1.2	7.8	1480	F 202_7.8	S3	M3LB2	102	F 202_7.8 P100 BN100LB2	103
418	87	2.7	6.9	2090	F 252_6.9	S3	M3LB2	106	F 252_6.9 P112 BN112M2	107
448	81	1.3	6.4	1420	F 202_6.4	S3	M3LB2	102	F 202_6.4 P100 BN100LB2	103

5.5 КВТ

n_2 мин-1	M_2 Нм	S	i	R_{n2} Н						
2.9	16458	0.9	495.6	55000	F 904_495.6	S4	M4SA4	132	F 904_495.6 P132 BN132S4	133
3.1	15192	0.9	457.5	55000	F 904_457.5	S4	M4SA4	132	F 904_457.5 P132 BN132S4	133
4.0	12017	1.2	361.8	55000	F 904_361.8	S4	M4SA4	132	F 904_361.8 P132 BN132S4	133
4.9	9668	1.4	291.1	55000	F 904_291.1	S4	M4SA4	132	F 904_291.1 P132 BN132S4	133
5.3	9096	0.9	273.9	45000	F 804_273.9	S4	M4SA4	129	F 804_273.9 P132 BN132S4	130
5.4	8925	1.6	268.7	55000	F 904_268.7	S4	M4SA4	132	F 904_268.7 P132 BN132S4	133
6.2	7685	1.8	231.4	55000	F 904_231.4	S4	M4SA4	132	F 904_231.4 P132 BN132S4	133
6.6	7256	1.1	218.5	45000	F 804_218.5	S4	M4SA4	129	F 804_218.5 P132 BN132S4	130
6.7	7093	2.0	213.6	55000	F 904_213.6	S4	M4SA4	132	F 904_213.6 P132 BN132S4	133
7.4	6590	2.1	194.2	55000	F 903_194.2	S4	M4SA4	132	F 903_194.2 P132 BN132S4	133
7.8	6266	1.3	184.6	45000	F 803_184.6	S4	M4SA4	129	F 803_184.6 P132 BN132S4	130
8.0	6083	2.3	179.2	55000	F 903_179.2	S4	M4SA4	132	F 903_179.2 P132 BN132S4	133
8.8	5527	2.5	162.8	55000	F 903_162.8	S4	M4SA4	132	F 903_162.8 P132 BN132S4	133
9.0	5438	1.5	160.2	45000	F 803_160.2	S4	M4SA4	129	F 803_160.2 P132 BN132S4	130
9.4	5222	1.0	153.8	35000	F 703_153.8	S4	M4SA4	126	F 703_153.8 P132 BN132S4	127
9.6	5101	2.7	150.3	55000	F 903_150.3	S4	M4SA4	132	F 903_150.3 P132 BN132S4	133
9.7	5020	1.6	147.9	45000	F 803_147.9	S4	M4SA4	129	F 803_147.9 P132 BN132S4	130
10.5	4661	3.0	137.3	55000	F 903_137.3	S4	M4SA4	132	F 903_137.3 P132 BN132S4	133
10.8	4513	1.1	133.0	35000	F 703_133.0	S4	M4SA4	126	F 703_133.0 P132 BN132S4	127
10.9	4504	1.8	132.7	45000	F 803_132.7	S4	M4SA4	129	F 803_132.7 P132 BN132S4	130
11.4	4303	3.3	126.8	55000	F 903_126.8	S4	M4SA4	132	F 903_126.8 P132 BN132S4	133
11.7	4165	1.2	122.7	35000	F 703_122.7	S4	M4SA4	126	F 703_122.7 P132 BN132S4	127
11.8	4157	1.9	122.5	45000	F 803_122.5	S4	M4SA4	129	F 803_122.5 P132 BN132S4	130
12.7	3861	2.1	113.8	45000	F 803_113.8	S4	M4SA4	129	F 803_113.8 P132 BN132S4	130
13.1	3720	1.3	109.6	35000	F 703_109.6	S4	M4SA4	126	F 703_109.6 P132 BN132S4	127

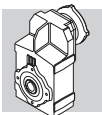

5.5 КВТ



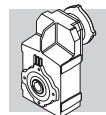

n_2 мин-1	M_2 Нм	S	i	R_{n2} Н				
14.2	3434	1.5	101.2	35000	F 703_101.2 S4 M4SA4	126	F 703_101.2 P132 BN132S4	127
15.6	3139	1.6	92.5	35000	F 703_92.5 S4 M4SA4	126	F 703_92.5 P132 BN132S4	127
15.6	3133	2.6	92.3	45000	F 803_92.3 S4 M4SA4	129	F 803_92.3 P132 BN132S4	130
16.9	2898	1.7	85.4	35000	F 703_85.4 S4 M4SA4	126	F 703_85.4 P132 BN132S4	127
16.9	2892	2.8	85.2	45000	F 803_85.2 S4 M4SA4	129	F 803_85.2 P132 BN132S4	130
17.1	2852	1.0	84.0	20000	F 603_84.0 S4 M4SA4	122	F 603_84.0 P132 BN132S4	123
18.6	2632	1.1	77.6	20000	F 603_77.6 S4 M4SA4	122	F 603_77.6 P132 BN132S4	123
18.9	2588	3.1	76.3	45000	F 803_76.3 S4 M4SA4	129	F 803_76.3 P132 BN132S4	130
19.6	2497	2.0	73.6	35000	F 703_73.6 S4 M4SA4	126	F 703_73.6 P132 BN132S4	127
20.5	2389	3.3	70.4	45000	F 803_70.4 S4 M4SA4	129	F 803_70.4 P132 BN132S4	130
21.1	2317	1.3	68.3	20000	F 603_68.3 S4 M4SA4	122	F 603_68.3 P132 BN132S4	123
21.2	2305	2.2	67.9	35000	F 703_67.9 S4 M4SA4	126	F 703_67.9 P132 BN132S4	127
22.8	2139	1.4	63.0	20000	F 603_63.0 S4 M4SA4	122	F 603_63.0 P132 BN132S4	123
23.0	2121	2.4	62.5	35000	F 703_62.5 S4 M4SA4	126	F 703_62.5 P132 BN132S4	127
25.0	1958	2.6	57.7	35000	F 703_57.7 S4 M4SA4	126	F 703_57.7 P132 BN132S4	127
27.8	1759	1.6	51.8	20000	F 603_51.8 S4 M4SA4	122	F 603_51.8 P132 BN132S4	123
29.4	1660	1.1	48.9	10300	F 513_48.9 S4 M4SA4	118	F 513_48.9 P132 BN132S4	119
29.4	1662	3.0	49.0	35000	F 703_49.0 S4 M4SA4	126	F 703_49.0 P132 BN132S4	127
30	1624	1.8	47.8	20000	F 603_47.8 S4 M4SA4	122	F 603_47.8 P132 BN132S4	123
32	1534	3.3	45.2	34300	F 703_45.2 S4 M4SA4	126	F 703_45.2 P132 BN132S4	127
34	1428	2.0	42.1	20000	F 603_42.1 S4 M4SA4	122	F 603_42.1 P132 BN132S4	123
37	1319	2.2	38.8	20000	F 603_38.8 S4 M4SA4	122	F 603_38.8 P132 BN132S4	123
39	1288	1.3	37.1	10300	F 512_37.1 S4 M4SA4	118	F 512_37.1 P132 BN132S4	119
45	1089	2.7	32.1	20000	F 603_32.1 S4 M4SA4	122	F 603_32.1 P132 BN132S4	123
48	1044	1.1	30.1	6580	F 412_30.1 S4 M4SA4	114	F 412_30.1 P132 BN132S4	115
48	1041	1.6	30.0	9950	F 512_30.0 S4 M4SA4	118	F 512_30.0 P132 BN132S4	119
49	1005	2.9	29.6	20000	F 603_29.6 S4 M4SA4	122	F 603_29.6 P132 BN132S4	123
57	863	2.2	25.4	20000	F 603_25.4 S4 M4SA4	122	F 603_25.4 P132 BN132S4	123
60	836	1.3	24.1	6580	F 412_24.1 S4 M4SA4	114	F 412_24.1 P132 BN132S4	115
61	825	2.0	23.8	9560	F 512_23.8 S4 M4SA4	118	F 512_23.8 P132 BN132S4	119
61	796	2.4	23.5	20000	F 603_23.5 S4 M4SA4	122	F 603_23.5 P132 BN132S4	123
70	701	2.7	20.7	20000	F 603_20.7 S4 M4SA4	122	F 603_20.7 P132 BN132S4	123
76	655	1.7	18.9	6480	F 412_18.9 S4 M4SA4	114	F 412_18.9 P132 BN132S4	115
76	647	2.9	19.1	20000	F 603_19.1 S4 M4SA4	122	F 603_19.1 P132 BN132S4	123
77	653	2.4	18.8	9110	F 512_18.8 S4 M4SA4	118	F 512_18.8 P132 BN132S4	119
84	593	1.8	17.1	6410	F 412_17.1 S4 M4SA4	114	F 412_17.1 P132 BN132S4	115
98	507	2.0	14.6	6280	F 412_14.6 S4 M4SA4	114	F 412_14.6 P132 BN132S4	115
103	485	2.9	14.0	8520	F 512_14.0 S4 M4SA4	118	F 512_14.0 P132 BN132S4	119
130	385	3.5	11.1	8050	F 512_11.1 S4 M4SA4	118	F 512_11.1 P132 BN132S4	119
134	373	2.4	10.8	5970	F 412_10.8 S4 M4SA4	114	F 412_10.8 P132 BN132S4	115
158	317	2.2	9.1	5810	F 412_9.1 S4 M4SA4	114	F 412_9.1 P132 BN132S4	115
159	314	3.5	9.1	7590	F 512_9.1 S4 M4SA4	118	F 512_9.1 P132 BN132S4	119
198	253	3.3	14.6	5510	F 412_14.6 S4 M4SA2	114	F 412_14.6 P132 BN132SA2	115
214	233	2.7	6.7	5430	F 412_6.7 S4 M4SA4	114	F 412_6.7 P132 BN132S4	115
268	186	3.9	10.8	5120	F 412_10.8 S4 M4SA2	114	F 412_10.8 P132 BN132SA2	115
316	158	3.9	9.1	4930	F 412_9.1 S4 M4SA2	114	F 412_9.1 P132 BN132SA2	115

7.5 КВТ

n_2 мин-1	M_2 Нм	S	i	R_{n2} Н				
4.0	16387	0.9	361.8	55000	F 904_361.8 S4 M4LA4	132	F 904_361.8 P132 BN132MA4	133
4.9	13184	1.1	291.1	55000	F 904_291.1 S4 M4LA4	132	F 904_291.1 P132 BN132MA4	133
5.4	12170	1.2	268.7	55000	F 904_268.7 S4 M4LA4	132	F 904_268.7 P132 BN132MA4	133
6.2	10479	1.3	231.4	55000	F 904_231.4 S4 M4LA4	132	F 904_231.4 P132 BN132MA4	133
6.7	9673	1.4	213.6	55000	F 904_213.6 S4 M4LA4	132	F 904_213.6 P132 BN132MA4	133
7.4	8986	1.6	194.2	55000	F 903_194.2 S4 M4LA4	132	F 903_194.2 P132 BN132MA4	133
7.8	8544	0.9	184.6	45000	F 803_184.6 S4 M4LA4	129	F 803_184.6 P132 BN132MA4	130

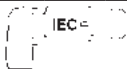

7.5 кВт

n ₂ МИН-1	M ₂ Нм	S	i	Rn ₂ Н			 IEC		
8.0	8295	1.7	179.2	55000	F 903_179.2 S4	M4LA4	132	F 903_179.2 P132 BN132MA4	133
8.8	7536	1.9	162.8	55000	F 903_162.8 S4	M4LA4	132	F 903_162.8 P132 BN132MA4	133
9.0	7416	1.1	160.2	45000	F 803_160.2 S4	M4LA4	129	F 803_160.2 P132 BN132MA4	130
9.6	6956	2.0	150.3	55000	F 903_150.3 S4	M4LA4	132	F 903_150.3 P132 BN132MA4	133
9.7	6845	1.2	147.9	45000	F 803_147.9 S4	M4LA4	129	F 803_147.9 P132 BN132MA4	130
10.5	6356	2.2	137.3	55000	F 903_137.3 S4	M4LA4	132	F 903_137.3 P132 BN132MA4	133
10.9	6141	1.3	132.7	45000	F 803_132.7 S4	M4LA4	129	F 803_132.7 P132 BN132MA4	130
11.4	5867	2.4	126.8	55000	F 903_126.8 S4	M4LA4	132	F 903_126.8 P132 BN132MA4	133
11.8	5669	1.4	122.5	45000	F 803_122.5 S4	M4LA4	129	F 803_122.5 P132 BN132MA4	130
12.7	5265	1.5	113.8	45000	F 803_113.8 S4	M4LA4	129	F 803_113.8 P132 BN132MA4	130
12.9	5181	2.7	111.9	55000	F 903_111.9 S4	M4LA4	132	F 903_111.9 P132 BN132MA4	133
13.1	5073	1.0	109.6	35000	F 703_109.6 S4	M4LA4	126	F 703_109.6 P132 BN132MA4	127
13.9	4783	2.9	103.3	55000	F 903_103.3 S4	M4LA4	132	F 903_103.3 P132 BN132MA4	133
14.2	4683	1.1	101.2	35000	F 703_101.2 S4	M4LA4	126	F 703_101.2 P132 BN132MA4	127
15.0	4432	3.2	95.8	55000	F 903_95.8 S4	M4LA4	132	F 903_95.8 P132 BN132MA4	133
15.6	4281	1.2	92.5	35000	F 703_92.5 S4	M4LA4	126	F 703_92.5 P132 BN132MA4	127
15.6	4272	1.9	92.3	45000	F 803_92.3 S4	M4LA4	129	F 803_92.3 P132 BN132MA4	130
16.3	4091	3.4	88.4	55000	F 903_88.4 S4	M4LA4	132	F 903_88.4 P132 BN132MA4	133
16.9	3952	1.3	85.4	35000	F 703_85.4 S4	M4LA4	126	F 703_85.4 P132 BN132MA4	127
16.9	3944	2.0	85.2	45000	F 803_85.2 S4	M4LA4	129	F 803_85.2 P132 BN132MA4	130
18.9	3529	2.3	76.3	45000	F 803_76.3 S4	M4LA4	129	F 803_76.3 P132 BN132MA4	130
19.6	3404	1.5	73.6	35000	F 703_73.6 S4	M4LA4	126	F 703_73.6 P132 BN132MA4	127
20.5	3258	2.5	70.4	44700	F 803_70.4 S4	M4LA4	129	F 803_70.4 P132 BN132MA4	130
21.1	3160	0.9	68.3	20000	F 603_68.3 S4	M4LA4	122	F 603_68.3 P132 BN132MA4	123
21.2	3143	1.6	67.9	35000	F 703_67.9 S4	M4LA4	126	F 703_67.9 P132 BN132MA4	127
22.8	2917	1.0	63.0	20000	F 603_63.0 S4	M4LA4	122	F 603_63.0 P132 BN132MA4	123
23.0	2893	1.7	62.5	35000	F 703_62.5 S4	M4LA4	126	F 703_62.5 P132 BN132MA4	127
23.4	2844	2.8	61.5	43500	F 803_61.5 S4	M4LA4	129	F 803_61.5 P132 BN132MA4	130
25.0	2670	1.9	57.7	34900	F 703_57.7 S4	M4LA4	126	F 703_57.7 P132 BN132MA4	127
25.4	2626	3.0	56.7	42600	F 803_56.7 S4	M4LA4	129	F 803_56.7 P132 BN132MA4	130
27.8	2399	1.2	51.8	20000	F 603_51.8 S4	M4LA4	122	F 603_51.8 P132 BN132MA4	123
29.4	2266	2.2	49.0	33800	F 703_49.0 S4	M4LA4	126	F 703_49.0 P132 BN132MA4	127
30	2214	1.3	47.8	20000	F 603_47.8 S4	M4LA4	122	F 603_47.8 P132 BN132MA4	123
32	2092	2.4	45.2	33200	F 703_45.2 S4	M4LA4	126	F 703_45.2 P132 BN132MA4	127
34	1948	1.5	42.1	20000	F 603_42.1 S4	M4LA4	122	F 603_42.1 P132 BN132MA4	123
37	1798	1.6	38.8	20000	F 603_38.8 S4	M4LA4	122	F 603_38.8 P132 BN132MA4	123
39	1756	1.0	37.1	9090	F 512_37.1 S4	M4LA4	118	F 512_37.1 P132 BN132MA4	119
45	1485	2.0	32.1	20000	F 603_32.1 S4	M4LA4	122	F 603_32.1 P132 BN132MA4	123
48	1420	1.2	30.0	9010	F 512_30.0 S4	M4LA4	118	F 512_30.0 P132 BN132MA4	119
49	1371	2.1	29.6	20000	F 603_29.6 S4	M4LA4	122	F 603_29.6 P132 BN132MA4	123
57	1176	1.6	25.4	20000	F 603_25.4 S4	M4LA4	122	F 603_25.4 P132 BN132MA4	123
59	1137	3.5	24.6	28800	F 703_24.6 S4	M4LA4	126	F 703_24.6 P132 BN132MA4	127
60	1140	1.0	24.1	5500	F 412_24.1 S4	M4LA4	114	F 412_24.1 P132 BN132MA4	115
61	1125	1.5	23.8	8810	F 512_23.8 S4	M4LA4	118	F 512_23.8 P132 BN132MA4	119
61	1086	1.7	23.5	20000	F 603_23.5 S4	M4LA4	122	F 603_23.5 P132 BN132MA4	123
70	956	2.0	20.7	20000	F 603_20.7 S4	M4LA4	122	F 603_20.7 P132 BN132MA4	123
76	893	1.2	18.9	5630	F 412_18.9 S4	M4LA4	114	F 412_18.9 P132 BN132MA4	115
76	883	2.2	19.1	20000	F 603_19.1 S4	M4LA4	122	F 603_19.1 P132 BN132MA4	123
77	890	1.7	18.8	8520	F 512_18.8 S4	M4LA4	118	F 512_18.8 P132 BN132MA4	119
84	809	1.3	17.1	5650	F 412_17.1 S4	M4LA4	114	F 412_17.1 P132 BN132MA4	115
92	726	2.6	15.7	20000	F 603_15.7 S4	M4LA4	122	F 603_15.7 P132 BN132MA4	123
98	692	1.5	14.6	5630	F 412_14.6 S4	M4LA4	114	F 412_14.6 P132 BN132MA4	115
99	670	2.8	14.5	20000	F 603_14.5 S4	M4LA4	122	F 603_14.5 P132 BN132MA4	123
103	661	2.1	14.0	8080	F 512_14.0 S4	M4LA4	118	F 512_14.0 P132 BN132MA4	119
113	589	3.2	12.7	19900	F 603_12.7 S4	M4LA4	122	F 603_12.7 P132 BN132MA4	123
123	544	3.5	11.8	19500	F 603_11.8 S4	M4LA4	122	F 603_11.8 P132 BN132MA4	123
130	525	2.5	11.1	7700	F 512_11.1 S4	M4LA4	118	F 512_11.1 P132 BN132MA4	119
134	509	1.8	10.8	5490	F 412_10.8 S4	M4LA4	114	F 412_10.8 P132 BN132MA4	115
158	432	1.6	9.1	5410	F 412_9.1 S4	M4LA4	114	F 412_9.1 P132 BN132MA4	115
159	428	2.6	9.1	7290	F 512_9.1 S4	M4LA4	118	F 512_9.1 P132 BN132MA4	119
200	340	2.9	7.2	6900	F 512_7.2 S4	M4LA4	118	F 512_7.2 P132 BN132MA4	119

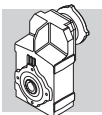

7.5 кВТ

n_2 мин-1	M_2 Нм	S	i	R_{n2} Н				
214	318	2.0	6.7	5140	F 412_6.7 S4 M4LA4	114	F 412_6.7 P132 BN132MA4	115
269	253	2.9	10.8	4880	F 412_10.8 S4 M4SB2	114	F 412_10.8 P132 BN132SB2	115
317	214	2.8	9.1	4730	F 412_9.1 S4 M4SB2	114	F 412_9.1 P132 BN132SB2	115
431	158	3.3	6.7	4390	F 412_6.7 S4 M4SB2	114	F 412_6.7 P132 BN132SB2	115

9.2 кВТ

n_2 мин-1	M_2 Нм	S	i	R_{n2} Н				
4.9	16172	0.9	291.1	55000	F 904_291.1 S4 M4LB4	132	F 904_291.1 P132 BN132MB4	133
5.4	14928	0.9	268.7	55000	F 904_268.7 S4 M4LB4	132	F 904_268.7 P132 BN132MB4	133
6.2	12854	1.1	231.4	55000	F 904_231.4 S4 M4LB4	132	F 904_231.4 P132 BN132MB4	133
6.7	11865	1.2	213.6	55000	F 904_213.6 S4 M4LB4	132	F 904_213.6 P132 BN132MB4	133
7.4	11023	1.3	194.2	55000	F 903_194.2 S4 M4LB4	132	F 903_194.2 P132 BN132MB4	133
8.0	10175	1.4	179.2	55000	F 903_179.2 S4 M4LB4	132	F 903_179.2 P132 BN132MB4	133
8.8	9244	1.5	162.8	55000	F 903_162.8 S4 M4LB4	132	F 903_162.8 P132 BN132MB4	133
9.6	8533	1.6	150.3	55000	F 903_150.3 S4 M4LB4	132	F 903_150.3 P132 BN132MB4	133
9.7	8397	1.0	147.9	45000	F 803_147.9 S4 M4LB4	129	F 803_147.9 P132 BN132MB4	130
10.5	7797	1.8	137.3	55000	F 903_137.3 S4 M4LB4	132	F 903_137.3 P132 BN132MB4	133
10.9	7533	1.1	132.7	45000	F 803_132.7 S4 M4LB4	129	F 803_132.7 P132 BN132MB4	130
11.4	7197	1.9	126.8	55000	F 903_126.8 S4 M4LB4	132	F 903_126.8 P132 BN132MB4	133
11.8	6954	1.2	122.5	45000	F 803_122.5 S4 M4LB4	129	F 803_122.5 P132 BN132MB4	130
12.7	6458	1.2	113.8	45000	F 803_113.8 S4 M4LB4	129	F 803_113.8 P132 BN132MB4	130
12.9	6355	2.2	111.9	55000	F 903_111.9 S4 M4LB4	132	F 903_111.9 P132 BN132MB4	133
13.9	5867	2.4	103.3	55000	F 903_103.3 S4 M4LB4	132	F 903_103.3 P132 BN132MB4	133
15.0	5437	2.6	95.8	55000	F 903_95.8 S4 M4LB4	132	F 903_95.8 P132 BN132MB4	133
15.6	5251	1.0	92.5	35000	F 703_92.5 S4 M4LB4	126	F 703_92.5 P132 BN132MB4	127
15.6	5241	1.5	92.3	45000	F 803_92.3 S4 M4LB4	129	F 803_92.3 P132 BN132MB4	130
16.3	5018	2.8	88.4	55000	F 903_88.4 S4 M4LB4	132	F 903_88.4 P132 BN132MB4	133
16.9	4848	1.0	85.4	35000	F 703_85.4 S4 M4LB4	126	F 703_85.4 P132 BN132MB4	127
16.9	4837	1.7	85.2	45000	F 803_85.2 S4 M4LB4	129	F 803_85.2 P132 BN132MB4	130
18.8	4352	3.2	76.7	55000	F 903_76.7 S4 M4LB4	132	F 903_76.7 P132 BN132MB4	133
18.9	4329	1.8	76.3	44100	F 803_76.3 S4 M4LB4	129	F 803_76.3 P132 BN132MB4	130
19.6	4176	1.2	73.6	35000	F 703_73.6 S4 M4LB4	126	F 703_73.6 P132 BN132MB4	127
20.4	4017	3.5	70.8	55000	F 903_70.8 S4 M4LB4	132	F 903_70.8 P132 BN132MB4	133
20.5	3996	2.0	70.4	43700	F 803_70.4 S4 M4LB4	129	F 803_70.4 P132 BN132MB4	130
21.2	3855	1.3	67.9	34600	F 703_67.9 S4 M4LB4	126	F 703_67.9 P132 BN132MB4	127
23.0	3548	1.4	62.5	34200	F 703_62.5 S4 M4LB4	126	F 703_62.5 P132 BN132MB4	127
23.4	3489	2.3	61.5	42200	F 803_61.5 S4 M4LB4	129	F 803_61.5 P132 BN132MB4	130
25.0	3275	1.5	57.7	33700	F 703_57.7 S4 M4LB4	126	F 703_57.7 P132 BN132MB4	127
25.4	3221	2.5	56.7	41400	F 803_56.7 S4 M4LB4	129	F 803_56.7 P132 BN132MB4	130
27.8	2942	1.0	51.8	20000	F 603_51.8 S4 M4LB4	122	F 603_51.8 P132 BN132MB4	123
29.4	2779	1.8	49.0	32800	F 703_49.0 S4 M4LB4	126	F 703_49.0 P132 BN132MB4	127
30	2716	1.1	47.8	20000	F 603_47.8 S4 M4LB4	122	F 603_47.8 P132 BN132MB4	123
32	2566	1.9	45.2	32300	F 703_45.2 S4 M4LB4	126	F 703_45.2 P132 BN132MB4	127
34	2389	1.2	42.1	20000	F 603_42.1 S4 M4LB4	122	F 603_42.1 P132 BN132MB4	123
37	2205	1.3	38.8	20000	F 603_38.8 S4 M4LB4	122	F 603_38.8 P132 BN132MB4	123
45	1821	1.6	32.1	20000	F 603_32.1 S4 M4LB4	122	F 603_32.1 P132 BN132MB4	123
48	1742	1.0	30.0	8210	F 512_30.0 S4 M4LB4	118	F 512_30.0 P132 BN132MB4	119
49	1681	1.7	29.6	20000	F 603_29.6 S4 M4LB4	122	F 603_29.6 P132 BN132MB4	123
57	1443	1.3	25.4	20000	F 603_25.4 S4 M4LB4	122	F 603_25.4 P132 BN132MB4	123
59	1394	2.9	24.6	28300	F 703_24.6 S4 M4LB4	126	F 703_24.6 P132 BN132MB4	127
61	1380	1.2	23.8	8170	F 512_23.8 S4 M4LB4	118	F 512_23.8 P132 BN132MB4	119
61	1332	1.4	23.5	20000	F 603_23.5 S4 M4LB4	122	F 603_23.5 P132 BN132MB4	123
64	1283	3.4	22.6	27800	F 703_22.6 S4 M4LB4	126	F 703_22.6 P132 BN132MB4	127
69	1185	3.4	20.9	27200	F 703_20.9 S4 M4LB4	126	F 703_20.9 P132 BN132MB4	127
70	1173	1.6	20.7	20000	F 603_20.7 S4 M4LB4	122	F 603_20.7 P132 BN132MB4	123
76	1096	1.0	18.9	4920	F 412_18.9 S4 M4LB4	114	F 412_18.9 P132 BN132MB4	115
76	1083	1.8	19.1	20000	F 603_19.1 S4 M4LB4	122	F 603_19.1 P132 BN132MB4	123

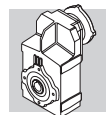

9.2 КВТ

n ₂ МИН-1	M ₂ Нм	S	i	Rn ₂ Н				
77	1092	1.4	18.8	8020	F 512_18.8 S4 M4LB4	118	F 512_18.8 P132 BN132MB4	119
84	993	1.1	17.1	5000	F 412_17.1 S4 M4LB4	114	F 412_17.1 P132 BN132MB4	115
92	890	2.1	15.7	20000	F 603_15.7 S4 M4LB4	122	F 603_15.7 P132 BN132MB4	123
98	848	1.2	14.6	5070	F 412_14.6 S4 M4LB4	114	F 412_14.6 P132 BN132MB4	115
99	822	2.3	14.5	20000	F 603_14.5 S4 M4LB4	122	F 603_14.5 P132 BN132MB4	123
103	811	1.8	14.0	7700	F 512_14.0 S4 M4LB4	118	F 512_14.0 P132 BN132MB4	119
113	723	2.6	12.7	19700	F 603_12.7 S4 M4LB4	122	F 603_12.7 P132 BN132MB4	123
123	667	2.8	11.8	19300	F 603_11.8 S4 M4LB4	122	F 603_11.8 P132 BN132MB4	123
130	644	2.1	11.1	7400	F 512_11.1 S4 M4LB4	118	F 512_11.1 P132 BN132MB4	119
134	625	1.4	10.8	5080	F 412_10.8 S4 M4LB4	114	F 412_10.8 P132 BN132MB4	115
148	551	3.4	9.7	18400	F 603_9.7 S4 M4LB4	122	F 603_9.7 P132 BN132MB4	123
158	530	1.3	9.1	5080	F 412_9.1 S4 M4LB4	114	F 412_9.1 P132 BN132MB4	115
159	525	2.1	9.1	7040	F 512_9.1 S4 M4LB4	118	F 512_9.1 P132 BN132MB4	119
200	417	2.3	7.2	6700	F 512_7.2 S4 M4LB4	118	F 512_7.2 P132 BN132MB4	119
214	390	1.6	6.7	4890	F 412_6.7 S4 M4LB4	114	F 412_6.7 P132 BN132MB4	115
264	317	3.4	11.1	6340	F 512_11.1 S4 M4LA2	118	F 512_11.1 P132 BN132M2	119
272	307	2.4	10.8	4680	F 412_10.8 S4 M4LA2	114	F 412_10.8 P132 BN132M2	115
321	260	2.3	9.1	4560	F 412_9.1 S4 M4LA2	114	F 412_9.1 P132 BN132M2	115
324	258	3.5	9.1	5980	F 512_9.1 S4 M4LA2	118	F 512_9.1 P132 BN132M2	119
436	192	2.7	6.7	4270	F 412_6.7 S4 M4LA2	114	F 412_6.7 P132 BN132M2	115

11 КВТ

n ₂ МИН-1	M ₂ Нм	S	i	Rn ₂ Н				
6.2	15369	0.9	231.4	55000	F 904_231.4 S4 M4LC4	132	F 904_231.4 P160 BN160MR4	133
6.7	14187	1.0	213.6	55000	F 904_213.6 S4 M4LC4	132	F 904_213.6 P160 BN160MR4	133
7.4	13179	1.1	194.2	55000	F 903_194.2 S4 M4LC4	132	F 903_194.2 P160 BN160MR4	133
8.0	12165	1.2	179.2	55000	F 903_179.2 S4 M4LC4	132	F 903_179.2 P160 BN160MR4	133
8.8	11053	1.3	162.8	55000	F 903_162.8 S4 M4LC4	132	F 903_162.8 P160 BN160MR4	133
9.6	10203	1.4	150.3	55000	F 903_150.3 S4 M4LC4	132	F 903_150.3 P160 BN160MR4	133
10.5	9323	1.5	137.3	55000	F 903_137.3 S4 M4LC4	132	F 903_137.3 P160 BN160MR4	133
11.4	8606	1.6	126.8	55000	F 903_126.8 S4 M4LC4	132	F 903_126.8 P160 BN160MR4	133
11.8	8314	1.0	122.5	45000	F 803_122.5 S4 M4LC4	129	F 803_122.5 P160 BN160MR4	130
12.7	7721	1.0	113.8	45000	F 803_113.8 S4 M4LC4	129	F 803_113.8 P160 BN160MR4	130
12.9	7599	1.8	111.9	55000	F 903_111.9 S4 M4LC4	132	F 903_111.9 P160 BN160MR4	133
13.9	7014	2.0	103.3	55000	F 903_103.3 S4 M4LC4	132	F 903_103.3 P160 BN160MR4	133
15.0	6500	2.2	95.8	55000	F 903_95.8 S4 M4LC4	132	F 903_95.8 P160 BN160MR4	133
15.6	6266	1.3	92.3	44100	F 803_92.3 S4 M4LC4	129	F 803_92.3 P160 BN160MR4	130
16.3	6000	2.3	88.4	55000	F 903_88.4 S4 M4LC4	132	F 903_88.4 P160 BN160MR4	133
16.9	5784	1.4	85.2	44000	F 803_85.2 S4 M4LC4	129	F 803_85.2 P160 BN160MR4	130
18.8	5203	2.7	76.7	55000	F 903_76.7 S4 M4LC4	132	F 903_76.7 P160 BN160MR4	133
18.9	5176	1.5	76.3	42800	F 803_76.3 S4 M4LC4	129	F 803_76.3 P160 BN160MR4	130
19.6	4993	1.0	73.6	33500	F 703_73.6 S4 M4LC4	126	F 703_73.6 P160 BN160MR4	127
20.4	4803	2.9	70.8	55000	F 903_70.8 S4 M4LC4	132	F 903_70.8 P160 BN160MR4	133
20.5	4778	1.7	70.4	42500	F 803_70.4 S4 M4LC4	129	F 803_70.4 P160 BN160MR4	130
21.2	4609	1.1	67.9	33100	F 703_67.9 S4 M4LC4	126	F 703_67.9 P160 BN160MR4	127
23.0	4243	1.2	62.5	32900	F 703_62.5 S4 M4LC4	126	F 703_62.5 P160 BN160MR4	127
23.2	4215	3.3	62.1	55000	F 903_62.1 S4 M4LC4	132	F 903_62.1 P160 BN160MR4	133
23.4	4172	1.9	61.5	41100	F 803_61.5 S4 M4LC4	129	F 803_61.5 P160 BN160MR4	130
25.0	3916	1.3	57.7	32500	F 703_57.7 S4 M4LC4	126	F 703_57.7 P160 BN160MR4	127
25.4	3851	2.1	56.7	40800	F 803_56.7 S4 M4LC4	129	F 803_56.7 P160 BN160MR4	130
29.3	3333	2.4	49.1	39300	F 803_49.1 S4 M4LC4	129	F 803_49.1 P160 BN160MR4	130
29.4	3323	1.5	49.0	31800	F 703_49.0 S4 M4LC4	126	F 703_49.0 P160 BN160MR4	127
32	3068	1.6	45.2	31300	F 703_45.2 S4 M4LC4	126	F 703_45.2 P160 BN160MR4	127
32	3077	2.6	45.3	38900	F 803_45.3 S4 M4LC4	129	F 803_45.3 P160 BN160MR4	130
34	2857	1.0	42.1	20000	F 603_42.1 S4 M4LC4	122	F 603_42.1 P160 BN160MR4	123
37	2637	1.1	38.8	20000	F 603_38.8 S4 M4LC4	122	F 603_38.8 P160 BN160MR4	123

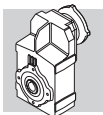

11 кВТ



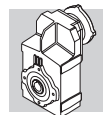

n ₂ мин-1	M ₂ Нм	S	i	R _{n2} Н						
38	2606	1.9	38.4	30500				F 703_38.4	P160 BN160MR4	127
41	2406	2.1	35.4	30000				F 703_35.4	P160 BN160MR4	127
45	2178	1.3	32.1	20000	F 603_32.1	S4 M4LC4	122	F 603_32.1	P160 BN160MR4	123
49	2010	1.4	29.6	20000	F 603_29.6	S4 M4LC4	122	F 603_29.6	P160 BN160MR4	123
52	1880	2.5	27.7	28500				F 703_27.7	P160 BN160MR4	127
57	1725	1.1	25.4	20000	F 603_25.4	S4 M4LC4	122	F 603_25.4	P160 BN160MR4	123
59	1667	2.4	24.6	27800	F 703_24.6	S4 M4LC4	126	F 703_24.6	P160 BN160MR4	127
61	1650	1.0	23.8	7500	F 512_23.8	S4 M4LC4	118	F 512_23.8	P160 BN160MR4	119
61	1593	1.2	23.5	20000	F 603_23.5	S4 M4LC4	122	F 603_23.5	P160 BN160MR4	123
64	1534	2.8	22.6	27300	F 703_22.6	S4 M4LC4	126	F 703_22.6	P160 BN160MR4	127
69	1416	2.8	20.9	26800	F 703_20.9	S4 M4LC4	126	F 703_20.9	P160 BN160MR4	127
70	1402	1.4	20.7	20000	F 603_20.7	S4 M4LC4	122	F 603_20.7	P160 BN160MR4	123
76	1294	1.5	19.1	20000	F 603_19.1	S4 M4LC4	122	F 603_19.1	P160 BN160MR4	123
77	1305	1.2	18.8	7490	F 512_18.8	S4 M4LC4	118	F 512_18.8	P160 BN160MR4	119
92	1064	1.8	15.7	20000	F 603_15.7	S4 M4LC4	122	F 603_15.7	P160 BN160MR4	123
98	1014	1.0	14.6	4490	F 412_14.6	S4 M4LC4	114	F 412_14.6	P160 BN160MR4	115
99	982	1.9	14.5	20000	F 603_14.5	S4 M4LC4	122	F 603_14.5	P160 BN160MR4	123
103	969	1.5	14.0	7310	F 512_14.0	S4 M4LC4	118	F 512_14.0	P160 BN160MR4	119
113	864	2.2	12.7	19400	F 603_12.7	S4 M4LC4	122	F 603_12.7	P160 BN160MR4	123
123	798	2.4	11.8	19000	F 603_11.8	S4 M4LC4	122	F 603_11.8	P160 BN160MR4	123
130	770	1.7	11.1	7090	F 512_11.1	S4 M4LC4	118	F 512_11.1	P160 BN160MR4	119
134	747	1.2	10.8	4650	F 412_10.8	S4 M4LC4	114	F 412_10.8	P160 BN160MR4	115
148	659	2.9	9.7	18200	F 603_9.7	S4 M4LC4	122	F 603_9.7	P160 BN160MR4	123
158	633	1.1	9.1	4720	F 412_9.1	S4 M4LC4	114	F 412_9.1	P160 BN160MR4	115
159	628	1.8	9.1	6770	F 512_9.1	S4 M4LC4	118	F 512_9.1	P160 BN160MR4	119
161	608	3.1	9.0	17800	F 603_9.0	S4 M4LC4	122	F 603_9.0	P160 BN160MR4	123
200	499	2.0	7.2	6490	F 512_7.2	S4 M4LC4	118	F 512_7.2	P160 BN160MR4	119
214	466	1.4	6.7	4630	F 412_6.7	S4 M4LC4	114	F 412_6.7	P160 BN160MR4	115
263	380	2.8	11.1	6170	F 512_11.1	S4 M4LC2	118	F 512_11.1	P160 BN160MR2	119
271	368	2.0	10.8	4460	F 412_10.8	S4 M4LC2	114	F 412_10.8	P160 BN160MR2	115
320	312	2.0	9.1	4380	F 412_9.1	S4 M4LC2	114	F 412_9.1	P160 BN160MR2	115
323	310	2.9	9.1	5840	F 512_9.1	S4 M4LC2	118	F 512_9.1	P160 BN160MR2	119
406	246	3.2	7.2	5510	F 512_7.2	S4 M4LC2	118	F 512_7.2	P160 BN160MR2	119
434	230	2.3	6.7	4130	F 412_6.7	S4 M4LC2	114	F 412_6.7	P160 BN160MR2	115

15 кВТ



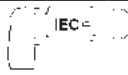

n ₂ мин-1	M ₂ Нм	S	i	R _{n2} Н						
8.1	16362	0.9	179.2	55000	F 903_179.2	S5 M5SB4	132	F 903_179.2	P160 BN160L4	133
9.0	14866	0.9	162.8	55000	F 903_162.8	S5 M5SB4	132	F 903_162.8	P160 BN160L4	133
9.7	13722	1.0	150.3	55000	F 903_150.3	S5 M5SB4	132	F 903_150.3	P160 BN160L4	133
10.6	12539	1.1	137.3	55000	F 903_137.3	S5 M5SB4	132	F 903_137.3	P160 BN160L4	133
11.5	11574	1.2	126.8	55000	F 903_126.8	S5 M5SB4	132	F 903_126.8	P160 BN160L4	133
13.0	10220	1.4	111.9	55000	F 903_111.9	S5 M5SB4	132	F 903_111.9	P160 BN160L4	133
14.1	9434	1.5	103.3	55000	F 903_103.3	S5 M5SB4	132	F 903_103.3	P160 BN160L4	133
15.2	8743	1.6	95.8	55000	F 903_95.8	S5 M5SB4	132	F 903_95.8	P160 BN160L4	133
15.8	8427	0.9	92.3	41300	F 803_92.3	S5 M5SB4	129	F 803_92.3	P160 BN160L4	130
16.5	8070	1.7	88.4	55000	F 903_88.4	S5 M5SB4	132	F 903_88.4	P160 BN160L4	133
17.1	7779	1.0	85.2	40800	F 803_85.2	S5 M5SB4	129	F 803_85.2	P160 BN160L4	130
19.0	6998	2.0	76.7	55000	F 903_76.7	S5 M5SB4	132	F 903_76.7	P160 BN160L4	133
19.1	6961	1.1	76.3	40500	F 803_76.3	S5 M5SB4	129	F 803_76.3	P160 BN160L4	130
20.6	6460	2.2	70.8	55000	F 903_70.8	S5 M5SB4	132	F 903_70.8	P160 BN160L4	133
20.7	6426	1.2	70.4	39900	F 803_70.4	S5 M5SB4	129	F 803_70.4	P160 BN160L4	130
23.5	5669	2.5	62.1	55000	F 903_62.1	S5 M5SB4	132	F 903_62.1	P160 BN160L4	133
23.8	5611	1.4	61.5	38700	F 803_61.5	S5 M5SB4	129	F 803_61.5	P160 BN160L4	130
25.3	5267	0.9	57.7	29700	F 703_57.7	S5 M5SB4	126	F 703_57.7	P160 BN160L4	127
25.5	5233	2.7	57.3	55000	F 903_57.3	S5 M5SB4	132	F 903_57.3	P160 BN160L4	133
25.7	5179	1.5	56.7	38600	F 803_56.7	S5 M5SB4	129	F 803_56.7	P160 BN160L4	130



15 кВт

n ₂ мин-1	M ₂ Нм	S	i	R _{n2} Н				
29.7	4483	1.8	49.1	37800	F 803_49.1 S5 M5SB4	129	F 803_49.1 P160 BN160L4	130
29.8	4470	1.1	49.0	29400	F 703_49.0 S5 M5SB4	126	F 703_49.0 P160 BN160L4	127
32	4126	1.2	45.2	29100	F 703_45.2 S5 M5SB4	126	F 703_45.2 P160 BN160L4	127
32	4138	1.9	45.3	37200	F 803_45.3 S5 M5SB4	129	F 803_45.3 P160 BN160L4	130
38	3505	1.4	38.4	28600	F 703_38.4 S5 M5SB4	126	F 703_38.4 P160 BN160L4	127
41	3235	1.5	35.4	28200	F 703_35.4 S5 M5SB4	126	F 703_35.4 P160 BN160L4	127
46	2929	1.0	32.1	20000	F 603_32.1 S5 M5SB4	122	F 603_32.1 P160 BN160L4	123
49	2704	1.1	29.6	20000	F 603_29.6 S5 M5SB4	122	F 603_29.6 P160 BN160L4	123
53	2528	1.8	27.7	27100	F 703_27.7 S5 M5SB4	126	F 703_27.7 P160 BN160L4	127
58	2303	2.7	25.2	32900	F 803_25.2 S5 M5SB4	129	F 803_25.2 P160 BN160L4	130
59	2242	1.8	24.6	26500	F 703_24.6 S5 M5SB4	126	F 703_24.6 P160 BN160L4	127
65	2064	2.1	22.6	26200	F 703_22.6 S5 M5SB4	126	F 703_22.6 P160 BN160L4	127
66	2011	3.4	22.0	31900	F 803_22.0 S5 M5SB4	129	F 803_22.0 P160 BN160L4	130
70	1905	2.1	20.9	25700	F 703_20.9 S5 M5SB4	126	F 703_20.9 P160 BN160L4	127
71	1886	1.0	20.7	20000	F 603_20.7 S5 M5SB4	122	F 603_20.7 P160 BN160L4	123
72	1856	3.4	20.3	31300	F 803_20.3 S5 M5SB4	129	F 803_20.3 P160 BN160L4	130
77	1741	1.1	19.1	20000	F 603_19.1 S5 M5SB4	122	F 603_19.1 P160 BN160L4	123
82	1617	2.7	17.7	24900	F 703_17.7 S5 M5SB4	126	F 703_17.7 P160 BN160L4	127
89	1492	2.7	16.3	24400	F 703_16.3 S5 M5SB4	126	F 703_16.3 P160 BN160L4	127
93	1432	1.3	15.7	19600	F 603_15.7 S5 M5SB4	122	F 603_15.7 P160 BN160L4	123
101	1321	1.4	14.5	19200	F 603_14.5 S5 M5SB4	122	F 603_14.5 P160 BN160L4	123
105	1268	3.1	13.9	23600	F 703_13.9 S5 M5SB4	126	F 703_13.9 P160 BN160L4	127
114	1170	3.1	12.8	23100	F 703_12.8 S5 M5SB4	126	F 703_12.8 P160 BN160L4	127
115	1162	1.6	12.7	18800	F 603_12.7 S5 M5SB4	122	F 603_12.7 P160 BN160L4	123
124	1073	1.8	11.8	18400	F 603_11.8 S5 M5SB4	122	F 603_11.8 P160 BN160L4	123
135	991	3.5	10.9	22300	F 703_10.9 S5 M5SB4	126	F 703_10.9 P160 BN160L4	127
146	914	3.5	10.0	21800	F 703_10.0 S5 M5SB4	126	F 703_10.0 P160 BN160L4	127
150	886	2.1	9.7	17700	F 603_9.7 S5 M5SB4	122	F 603_9.7 P160 BN160L4	123
163	818	2.3	9.0	17300	F 603_9.0 S5 M5SB4	122	F 603_9.0 P160 BN160L4	123

18.5 кВт

n ₂ мин-1	M ₂ Нм	S	i	R _{n2} Н				
10.6	15456	0.9	137.3	55000	F 903_137.3 S5 M5LA4	132	F 903_137.3 P180 BN180M4	133
11.5	14267	1.0	126.8	55000	F 903_126.8 S5 M5LA4	132	F 903_126.8 P180 BN180M4	133
13.0	12598	1.1	111.9	55000	F 903_111.9 S5 M5LA4	132	F 903_111.9 P180 BN180M4	133
14.1	11629	1.2	103.3	55000	F 903_103.3 S5 M5LA4	132	F 903_103.3 P180 BN180M4	133
15.2	10777	1.3	95.8	55000	F 903_95.8 S5 M5LA4	132	F 903_95.8 P180 BN180M4	133
16.5	9948	1.4	88.4	55000	F 903_88.4 S5 M5LA4	132	F 903_88.4 P180 BN180M4	133
19.0	8626	1.6	76.7	55000	F 903_76.7 S5 M5LA4	132	F 903_76.7 P180 BN180M4	133
19.1	8581	0.9	76.3	38100	F 803_76.3 S5 M5LA4	129	F 803_76.3 P180 BN180M4	130
20.6	7963	1.8	70.8	55000	F 903_70.8 S5 M5LA4	132	F 903_70.8 P180 BN180M4	133
20.7	7921	1.0	70.4	37600	F 803_70.4 S5 M5LA4	129	F 803_70.4 P180 BN180M4	130
23.5	6989	2.0	62.1	55000	F 903_62.1 S5 M5LA4	132	F 903_62.1 P180 BN180M4	133
23.8	6916	1.1	61.5	37400	F 803_61.5 S5 M5LA4	129	F 803_61.5 P180 BN180M4	130
25.5	6451	2.2	57.3	55000	F 903_57.3 S5 M5LA4	132	F 903_57.3 P180 BN180M4	133
25.7	6384	1.3	56.7	36800	F 803_56.7 S5 M5LA4	129	F 803_56.7 P180 BN180M4	130
29.3	5615	2.5	49.9	55000	F 903_49.9 S5 M5LA4	132	F 903_49.9 P180 BN180M4	133
29.7	5526	1.4	49.1	35800	F 803_49.1 S5 M5LA4	129	F 803_49.1 P180 BN180M4	130
29.8	5510	0.9	49.0	27400	F 703_49.0 S5 M5LA4	126	F 703_49.0 P180 BN180M4	127
32	5183	2.7	46.1	55000	F 903_46.1 S5 M5LA4	132	F 903_46.1 P180 BN180M4	133
32	5101	1.6	45.3	35700	F 803_45.3 S5 M5LA4	129	F 803_45.3 P180 BN180M4	130
32	5086	1.0	45.2	27200	F 703_45.2 S5 M5LA4	126	F 703_45.2 P180 BN180M4	127
36	4558	3.1	40.5	53700			F 903_40.5 P180 BN180M4	133
37	4389	1.8	39.0	35000	F 803_39.0 S5 M5LA4	129	F 803_39.0 P180 BN180M4	130
38	4321	1.2	38.4	27000	F 703_38.4 S5 M5LA4	126	F 703_38.4 P180 BN180M4	127

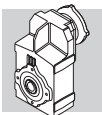

18.5 КВТ

n_2 мин-1	M_2 Нм	S	i	R_{n2} Н				
39	4207	3.2	37.4	52700				
41	4051	2.0	36.0	34400	F 803_36.0 S5 M5LA4	129	F 903_37.4 P180 BN180M4	133
41	3988	1.3	35.4	26700	F 703_35.4 S5 M5LA4	126	F 803_36.0 P180 BN180M4	130
47	3517	2.3	31.3	33600			F 703_35.4 P180 BN180M4	127
49	3376	1.5	30.0	26300	F 703_30.0 S5 M5LA4	126	F 803_31.3 P180 BN180M4	130
							F 703_30.0 P180 BN180M4	127
51	3246	2.5	28.8	33000			F 803_28.8 P180 BN180M4	130
53	3116	1.5	27.7	26000	F 703_27.7 S5 M5LA4	126	F 703_27.7 P180 BN180M4	127
58	2839	2.2	25.2	32100	F 803_25.2 S5 M5LA4	129	F 803_25.2 P180 BN180M4	130
59	2764	1.4	24.6	25500	F 703_24.6 S5 M5LA4	126	F 703_24.6 P180 BN180M4	127
65	2544	1.7	22.6	25200	F 703_22.6 S5 M5LA4	126	F 703_22.6 P180 BN180M4	127
66	2479	2.7	22.0	31300	F 803_22.0 S5 M5LA4	129	F 803_22.0 P180 BN180M4	130
70	2348	1.7	20.9	24900	F 703_20.9 S5 M5LA4	126	F 703_20.9 P180 BN180M4	127
72	2288	2.7	20.3	30600	F 803_20.3 S5 M5LA4	129	F 803_20.3 P180 BN180M4	130
82	1993	2.2	17.7	24200	F 703_17.7 S5 M5LA4	126	F 703_17.7 P180 BN180M4	127
83	1981	3.4	17.6	29700	F 803_17.6 S5 M5LA4	129	F 803_17.6 P180 BN180M4	130
89	1839	2.2	16.3	23800	F 703_16.3 S5 M5LA4	126	F 703_16.3 P180 BN180M4	127
90	1828	3.4	16.2	29100	F 803_16.2 S5 M5LA4	129	F 803_16.2 P180 BN180M4	130
93	1765	1.1	15.7	18700	F 603_15.7 S5 M5LA4	122	F 603_15.7 P180 BN180M4	123
101	1629	1.2	14.5	18600	F 603_14.5 S5 M5LA4	122	F 603_14.5 P180 BN180M4	123
105	1563	2.5	13.9	23000	F 703_13.9 S5 M5LA4	126	F 703_13.9 P180 BN180M4	127
114	1442	2.5	12.8	22600	F 703_12.8 S5 M5LA4	126	F 703_12.8 P180 BN180M4	127
115	1433	1.3	12.7	18300	F 603_12.7 S5 M5LA4	122	F 603_12.7 P180 BN180M4	123
124	1323	1.4	11.8	17900	F 603_11.8 S5 M5LA4	122	F 603_11.8 P180 BN180M4	123
135	1221	2.8	10.9	21800	F 703_10.9 S5 M5LA4	126	F 703_10.9 P180 BN180M4	127
146	1127	2.8	10.0	21400	F 703_10.0 S5 M5LA4	126	F 703_10.0 P180 BN180M4	127
150	1092	1.7	9.7	17300	F 603_9.7 S5 M5LA4	122	F 603_9.7 P180 BN180M4	123
163	1008	1.9	9.0	16900	F 603_9.0 S5 M5LA4	122	F 603_9.0 P180 BN180M4	123

22 КВТ

n_2 мин-1	M_2 Нм	S	i	R_{n2} Н				
13.1	14880	0.9	111.9	55000			F 903_111.9 P180 BN180L4	133
14.2	13735	1.0	103.3	55000			F 903_103.3 P180 BN180L4	133
15.4	12728	1.1	95.8	55000			F 903_95.8 P180 BN180L4	133
16.6	11749	1.2	88.4	55000			F 903_88.4 P180 BN180L4	133
19.2	10188	1.4	76.7	55000			F 903_76.7 P180 BN180L4	133
20.8	9405	1.5	70.8	55000			F 903_70.8 P180 BN180L4	133
23.7	8254	1.7	62.1	55000			F 903_62.1 P180 BN180L4	133
23.9	8169	1.0	61.5	35400			F 803_61.5 P180 BN180L4	130
25.6	7619	1.8	57.3	55000			F 903_57.3 P180 BN180L4	133
25.9	7541	1.1	56.7	35000			F 803_56.7 P180 BN180L4	130
29.5	6632	2.1	49.9	54400			F 903_49.9 P180 BN180L4	133
29.9	6527	1.2	49.1	34100			F 803_49.1 P180 BN180L4	130
32	6122	2.3	46.1	53500			F 903_46.1 P180 BN180L4	133
32	6025	1.3	45.3	34300			F 803_45.3 P180 BN180L4	130
36	5383	2.6	40.5	52300			F 903_40.5 P180 BN180L4	133
38	5184	1.5	39.0	33300			F 803_39.0 P180 BN180L4	130
38	5103	1.0	38.4	25400			F 703_38.4 P180 BN180L4	127
39	4969	2.7	37.4	51400			F 903_37.4 P180 BN180L4	133
41	4785	1.7	36.0	33200			F 803_36.0 P180 BN180L4	130
41	4711	1.1	35.4	25300			F 703_35.4 P180 BN180L4	127
47	4154	1.9	31.3	32600			F 803_31.3 P180 BN180L4	130
47	4120	3.2	31.0	49500			F 903_31.0 P180 BN180L4	133
49	3988	1.3	30.0	25100			F 703_30.0 P180 BN180L4	127
51	3834	2.1	28.8	32000			F 803_28.8 P180 BN180L4	130
51	3803	3.2	28.6	48600			F 903_28.6 P180 BN180L4	133
53	3681	1.3	27.7	24800			F 703_27.7 P180 BN180L4	127

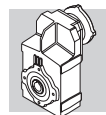

22 кВТ

n ₂ мин-1	M ₂ Нм	S	i	R _{n2} Н				
58	3353	1.9	25.2	31300			F 803_25.2 P180 BN180L4	130
60	3264	1.2	24.6	24500			F 703_24.6 P180 BN180L4	127
65	3005	1.4	22.6	24300			F 703_22.6 P180 BN180L4	127
67	2928	2.3	22.0	30200			F 803_22.0 P180 BN180L4	130
70	2773	1.4	20.9	24000			F 703_20.9 P180 BN180L4	127
72	2703	2.3	20.3	29900			F 803_20.3 P180 BN180L4	130
83	2354	1.8	17.7	23400			F 703_17.7 P180 BN180L4	127
84	2339	2.9	17.6	29100			F 803_17.6 P180 BN180L4	130
90	2173	1.8	16.3	23100			F 703_16.3 P180 BN180L4	127
90	2159	2.9	16.2	28500			F 803_16.2 P180 BN180L4	130
106	1846	2.1	13.9	22400			F 703_13.9 P180 BN180L4	127
115	1704	2.1	12.8	22100			F 703_12.8 P180 BN180L4	127
115	1692	1.1	12.7	17700			F 603_12.7 P180 BN180L4	123
125	1562	1.2	11.8	17400			F 603_11.8 P180 BN180L4	123
135	1442	2.4	10.9	21400			F 703_10.9 P180 BN180L4	127
147	1331	2.4	10.0	21000			F 703_10.0 P180 BN180L4	127
151	1290	1.5	9.7	16900			F 603_9.7 P180 BN180L4	123
164	1191	1.6	9.0	16500			F 603_9.0 P180 BN180L4	123

30 кВТ

n ₂ мин-1	M ₂ Нм	S	i	R _{n2} Н				
16.6	16022	0.9	88.4	52200			F 903_88.4 P200 BN200L4	133
19.2	13893	1.0	76.7	52400			F 903_76.7 P200 BN200L4	133
20.8	12825	1.1	70.8	52100			F 903_70.8 P200 BN200L4	133
23.7	11256	1.2	62.1	51800			F 903_62.1 P200 BN200L4	133
25.6	10390	1.3	57.3	51400			F 903_57.3 P200 BN200L4	133
29.5	9044	1.5	49.9	50800			F 903_49.9 P200 BN200L4	133
32	8348	1.7	46.1	50200			F 903_46.1 P200 BN200L4	133
32	8216	1.0	45.3	30900			F 803_45.3 P200 BN200L4	130
36	7341	1.9	40.5	49400			F 903_40.5 P200 BN200L4	133
38	7069	1.1	39.0	31000			F 803_39.0 P200 BN200L4	130
39	6776	2.0	37.4	48700			F 903_37.4 P200 BN200L4	133
41	6525	1.2	36.0	30600			F 803_36.0 P200 BN200L4	130
47	5664	1.4	31.3	29900			F 803_31.3 P200 BN200L4	130
47	5618	2.3	31.0	47300			F 903_31.0 P200 BN200L4	133
49	5438	0.9	30.0	22300			F 703_30.0 P200 BN200L4	127
51	5229	1.5	28.8	29500			F 803_28.8 P200 BN200L4	130
51	5186	2.3	28.6	46600			F 903_28.6 P200 BN200L4	133
53	5019	0.9	27.7	22200			F 703_27.7 P200 BN200L4	127
58	4601	2.6	25.4	45500			F 903_25.4 P200 BN200L4	133
58	4572	1.2	25.2	29500			F 803_25.2 P200 BN200L4	130
66	4039	3.0	22.3	44400			F 903_22.3 P200 BN200L4	133
67	3992	1.7	22.0	29000			F 803_22.0 P200 BN200L4	130
71	3728	3.0	20.6	43600			F 903_20.6 P200 BN200L4	133
72	3685	1.7	20.3	28500			F 803_20.3 P200 BN200L4	130
83	3209	1.4	17.7	21800			F 703_17.7 P200 BN200L4	127
84	3190	2.1	17.6	27900			F 803_17.6 P200 BN200L4	130
90	2963	1.4	16.3	21500			F 703_16.3 P200 BN200L4	127
90	2945	2.1	16.2	27400			F 803_16.2 P200 BN200L4	130
105	2534	2.7	14.0	26700			F 803_14.0 P200 BN200L4	130
106	2517	1.5	13.9	21100			F 703_13.9 P200 BN200L4	127
114	2339	2.7	12.9	26200			F 803_12.9 P200 BN200L4	130
115	2323	1.5	12.8	20900			F 703_12.8 P200 BN200L4	127
135	1967	1.8	10.9	20300			F 703_10.9 P200 BN200L4	127
142	1874	3.0	10.3	24900			F 803_10.3 P200 BN200L4	130
147	1815	1.8	10.0	20000			F 703_10.0 P200 BN200L4	127

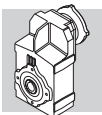

37 кВТ



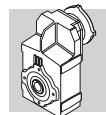

n ₂ МИН-1	M ₂ Нм	S	i	R _{n2} Н				
20.9	15710	0.9	70.8	47600			F 903_70.8 P225 BN225S4	133
25.8	12728	1.1	57.3	47700			F 903_57.3 P225 BN225S4	133
29.7	11079	1.3	49.9	47600			F 903_49.9 P225 BN225S4	133
32	10227	1.4	46.1	47200			F 903_46.1 P225 BN225S4	133
37	8993	1.6	40.5	46800			F 903_40.5 P225 BN225S4	133
38	8659	0.9	39.0	28500			F 803_39.0 P225 BN225S4	130
40	8301	1.6	37.4	46300			F 903_37.4 P225 BN225S4	133
41	7993	1.0	36.0	28300			F 803_36.0 P225 BN225S4	130
47	6939	1.2	31.3	28400			F 803_31.3 P225 BN225S4	130
48	6882	1.9	31.0	45300			F 903_31.0 P225 BN225S4	133
51	6405	1.2	28.8	28100			F 803_28.8 P225 BN225S4	130
52	6353	1.9	28.6	44700			F 903_28.6 P225 BN225S4	133
58	5637	2.1	25.4	43900			F 903_25.4 P225 BN225S4	133
59	5601	1.1	25.2	27800			F 803_25.2 P225 BN225S4	130
66	4947	2.4	22.3	43000			F 903_22.3 P225 BN225S4	133
67	4891	1.1	22.0	27600			F 803_22.0 P225 BN225S4	130
72	4567	2.5	20.6	42300			F 903_20.6 P225 BN225S4	133
73	4515	1.1	20.3	27200			F 803_20.3 P225 BN225S4	130
83	3975	2.8	17.9	41200			F 903_17.9 P225 BN225S4	133
84	3908	1.7	17.6	26800			F 803_17.6 P225 BN225S4	130
90	3669	2.8	16.5	40500			F 903_16.5 P225 BN225S4	133
91	3607	1.7	16.2	26300			F 803_16.2 P225 BN225S4	130
102	3226	3.1	14.5	39500			F 903_14.5 P225 BN225S4	133
106	3104	2.2	14.0	25800			F 803_14.0 P225 BN225S4	130
110	2978	3.1	13.4	38700			F 903_13.4 P225 BN225S4	133
115	2865	2.2	12.9	25300			F 803_12.9 P225 BN225S4	130
132	2487	2.4	11.2	24500			F 803_11.2 P225 BN225S4	130
143	2296	2.4	10.3	24300			F 803_10.3 P225 BN225S4	130

45 кВТ

n ₂ МИН-1	M ₂ Нм	S	i	R _{n2} Н				
32	12438	1.1	46.1	43900			F 903_46.1 P225 BN225M4	133
37	10937	1.3	40.5	43900			F 903_40.5 P225 BN225M4	133
40	10096	1.3	37.4	43600			F 903_37.4 P225 BN225M4	133
47	8439	0.9	31.3	26100			F 803_31.3 P225 BN225M4	130
48	8370	1.6	31.0	43100			F 903_31.0 P225 BN225M4	133
51	7790	1.0	28.8	26000			F 803_28.8 P225 BN225M4	130
52	7726	1.6	28.6	42600			F 903_28.6 P225 BN225M4	133
58	6855	1.8	25.4	42000			F 903_25.4 P225 BN225M4	133
66	6017	2.0	22.3	41400			F 903_22.3 P225 BN225M4	133
67	5948	1.1	22.0	26000			F 803_22.0 P225 BN225M4	130
72	5554	2.0	20.6	40800			F 903_20.6 P225 BN225M4	133
73	5491	1.1	20.3	25700			F 803_20.3 P225 BN225M4	130
83	4834	2.3	17.9	39900			F 903_17.9 P225 BN225M4	133
84	4753	1.4	17.6	25500			F 803_17.6 P225 BN225M4	130
90	4463	2.3	16.5	39300			F 903_16.5 P225 BN225M4	133
91	4387	1.4	16.2	25200			F 803_16.2 P225 BN225M4	130
102	3924	2.5	14.5	38400			F 903_14.5 P225 BN225M4	133
106	3775	1.8	14.0	24800			F 803_14.0 P225 BN225M4	130
110	3622	2.6	13.4	37800			F 903_13.4 P225 BN225M4	133
115	3484	1.8	12.9	24100			F 803_12.9 P225 BN225M4	130
132	3025	1.5	11.2	24000			F 803_11.2 P225 BN225M4	130
133	3003	2.9	11.1	36400			F 903_11.1 P225 BN225M4	133
143	2792	2.0	10.3	23500			F 803_10.3 P225 BN225M4	130



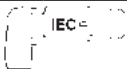

55 кВТ

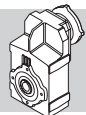
n₂ мин ⁻¹	M₂ Нм	S	i	R_{n2} Н			 IEC	
32	15202	0.9	46.1	39700			F 903_46.1 P250 BN250M4	133
37	13367	1.0	40.5	40300			F 903_40.5 P250 BN250M4	133
40	12339	1.1	37.4	40200			F 903_37.4 P250 BN250M4	133
48	10230	1.3	31.0	40300			F 903_31.0 P250 BN250M4	133
52	9443	1.3	28.6	40100			F 903_28.6 P250 BN250M4	133
58	8379	1.4	25.4	39700			F 903_25.4 P250 BN250M4	133
66	7354	1.6	22.3	39400			F 903_22.3 P250 BN250M4	133
72	6788	1.7	20.6	38900			F 903_20.6 P250 BN250M4	133
83	5909	1.9	17.9	38300			F 903_17.9 P250 BN250M4	133
90	5454	1.9	16.5	37800			F 903_16.5 P250 BN250M4	133
102	4796	2.1	14.5	37100			F 903_14.5 P250 BN250M4	133
110	4427	2.1	13.4	36600			F 903_13.4 P250 BN250M4	133
133	3671	2.4	11.1	35400			F 903_11.1 P250 BN250M4	133
144	3388	2.4	10.3	34800			F 903_10.3 P250 BN250M4	133



27 – ТАБЛИЦЫ ТЕХНИЧЕСКИХ ХАРАКТЕРИСТИК РЕДУКТОРОВ

	i	n ₁ = 2800 мин ⁻¹					n ₁ = 1400 мин ⁻¹					
		n ₂ мин ⁻¹	M _{n2} Нм	P _{n1} кВт	R _{n1} Н	R _{n2} Н	n ₂ мин ⁻¹	M _{n2} Нм	P _{n1} кВт	R _{n1} Н	R _{n2} Н	
F 10 2_ 7.4		378	63	2.6	1000	1290	189	76	1.6	1290	1640	99
F 10 2_ 8.6		326	67	2.4	980	1350	163	82	1.5	1260	1710	
F 10 2_ 9.8		287	73	2.3	980	1410	143	89	1.4	1250	1780	
F 10 2_ 11.5		243	78	2.1	950	1480	121	96	1.3	1220	1870	
F 10 2_ 13.0		215	85	2.0	940	1530	107	104	1.2	1210	1940	
F 10 2_ 14.6		191	94	2.0	1120	1590	96	119	1.3	1300	2000	
F 10 2_ 17.0		165	104	1.9	1090	1650	82	128	1.2	1300	2090	
F 10 2_ 19.3		145	108	1.7	1100	1730	72	136	1.1	1300	2180	
F 10 2_ 22.8		123	119	1.6	1080	1810	61	140	0.95	1300	2310	
F 10 2_ 25.8		109	123	1.5	1090	1890	54	140	0.84	1300	2430	
F 10 2_ 29.6		94	132	1.4	1060	1970	47	140	0.73	1300	2560	
F 10 2_ 33.0		85	137	1.3	1070	2040	42	140	0.65	1300	2670	
F 10 2_ 35.3		79	140	1.2	1060	2090	40	140	0.61	1300	2740	
F 10 2_ 39.6		71	140	1.1	1080	2190	35	140	0.54	1300	2800	
F 10 2_ 44.7		63	140	0.97	1080	2290	31	140	0.48	1300	2800	
F 10 2_ 48.7		57	140	0.89	1090	2370	28.7	140	0.44	1300	2800	
F 10 2_ 56.7		49	140	0.76	1100	2520	24.7	140	0.38	1300	2800	
F 10 2_ 63.0		44	140	0.69	1110	2620	22.2	140	0.34	1300	2800	
F 10 2_ 71.1		39	140	0.61	1000	2750	19.7	140	0.30	1300	2800	
F 10 2_ 81.3		34	140	0.53	1110	2800	17.2	140	0.27	1300	2800	
F 10 2_ 91.5		31	140	0.47	1110	2800	15.3	140	0.24	1300	2800	
F 10 2_ 106.0		26.4	140	0.41	1120	2800	13.2	140	0.20	1300	2800	
F 10 2_ 127.1		22.0	140	0.34	1130	2800	11.0	140	0.17	1300	2800	

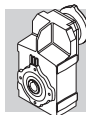

n ₁ = 900 мин ⁻¹						n ₁ = 500 мин ⁻¹					99
n ₂ мин ⁻¹	M _{n2} Нм	P _{n1} кВт	R _{n1} Н	R _{n2} Н	n ₂ мин ⁻¹	M _{n2} Нм	P _{n1} кВт	R _{n1} Н	R _{n2} Н		
F 10 2_ 7.4	122	91	1.2	1300	1890	68	111	0.83	1300	2300	
F 10 2_ 8.6	105	94	1.1	1300	1970	58	112	0.72	1300	2430	
F 10 2_ 9.8	92	107	1.1	1300	2050	51	130	0.73	1300	2490	
F 10 2_ 11.5	78	110	0.95	1300	2180	43	131	0.63	1300	2660	
F 10 2_ 13.0	69	124	0.94	1300	2240	38	140	0.59	1300	2800	
F 10 2_ 14.6	61	138	0.93	1300	2320	34	140	0.53	1300	2800	
F 10 2_ 17.0	53	140	0.82	1300	2450	29	140	0.46	1300	2800	
F 10 2_ 19.3	47	140	0.72	1300	2580	26	140	0.40	1300	2800	
F 10 2_ 22.8	39	140	0.61	1300	2750	22	140	0.34	1300	2800	
F 10 2_ 25.8	35	140	0.54	1300	2800	19	140	0.30	1300	2800	
F 10 2_ 29.6	30	140	0.47	1300	2800	17	140	0.26	1300	2800	
F 10 2_ 33.0	27	140	0.42	1300	2800	15	140	0.23	1300	2800	
F 10 2_ 35.3	25	140	0.39	1300	2800	14	140	0.22	1300	2800	
F 10 2_ 39.6	23	140	0.35	1300	2800	13	140	0.19	1300	2800	
F 10 2_ 44.7	20	140	0.31	1300	2800	11	140	0.17	1300	2800	
F 10 2_ 48.7	18	140	0.29	1300	2800	10.3	140	0.16	1300	2800	
F 10 2_ 56.7	16	140	0.24	1300	2800	8.8	140	0.14	1300	2800	
F 10 2_ 63.0	14	140	0.22	1300	2800	7.9	140	0.12	1300	2800	
F 10 2_ 71.1	13	140	0.20	1300	2800	7.0	140	0.11	1300	2800	
F 10 2_ 81.3	11	140	0.17	1300	2800	6.1	140	0.09	1300	2800	
F 10 2_ 91.5	10	140	0.15	1300	2800	5.5	140	0.08	1300	2800	
F 10 2_ 106.0	8.5	140	0.13	1300	2800	4.7	140	0.07	1300	2800	
F 10 2_ 127.1	7.1	140	0.11	1300	2800	3.9	140	0.06	1300	2800	



i	n ₁ = 2800 мин ⁻¹					n ₁ = 1400 мин ⁻¹					i
	n ₂ мин ⁻¹	M _{n2} Нм	P _{n1} кВт	R _{n1} Н	R _{n2} Н	n ₂ мин ⁻¹	M _{n2} Нм	P _{n1} кВт	R _{n1} Н	R _{n2} Н	
F 20 2_ 6.4	437	103	5.0	—	1370	218	130	3.1	—	1720	99
F 20 2_ 7.8	357	115	4.5	—	1440	179	144	2.8	—	1820	
F 20 2_ 8.7	321	123	4.3	—	1490	160	155	2.7	—	1870	
F 20 2_ 10.0	279	131	4.0	—	1550	140	165	2.5	—	1950	
F 20 2_ 11.2	249	141	3.9	—	1590	125	177	2.4	—	2010	
F 20 2_ 14.8	189	166	3.5	760	1740	95	203	2.1	1010	2210	
F 20 2_ 18.1	155	175	3.0	750	1870	77	213	1.8	1020	2380	
F 20 2_ 20.2	139	182	2.8	810	1940	69	223	1.7	1070	2460	
F 20 2_ 23.1	121	190	2.5	770	2030	60	235	1.6	1000	2570	
F 20 2_ 25.9	108	196	2.3	830	2110	54	240	1.4	1100	2680	
F 20 2_ 30.4	92	205	2.1	780	2230	46	250	1.3	1050	2840	
F 20 2_ 33.1	85	210	2.0	800	2300	42	250	1.2	1120	2940	
F 20 2_ 37.9	74	220	1.8	740	2400	37	250	1.0	1130	3110	
F 20 2_ 41.8	67	225	1.7	780	2490	33	250	0.92	1220	3240	
F 20 2_ 44.8	62	235	1.6	690	2540	31	250	0.86	1200	3330	
F 20 2_ 50.7	55	238	1.4	780	2660	27.6	250	0.76	1320	3500	
F 20 2_ 56.7	49	250	1.4	730	2750	24.7	250	0.68	1360	3660	
F 20 2_ 61.9	45	250	1.2	750	2860	22.6	250	0.62	1370	3790	
F 20 2_ 69.1	40	250	1.1	760	2990	20.2	250	0.56	1370	3950	
F 20 2_ 76.8	36	250	1.0	780	3130	18.2	250	0.50	1380	4000	
F 20 2_ 90.4	31	250	0.85	830	3340	15.5	250	0.43	1390	4000	
F 20 2_ 101.6	27.5	250	0.76	830	3500	13.8	250	0.38	1390	4000	
F 20 2_ 114.3	24.5	250	0.67	850	3670	12.2	250	0.34	1400	4000	
F 20 2_ 132.2	21.2	250	0.58	870	3890	10.6	250	0.29	1400	4000	
F 20 3_ 156.3	17.9	250	0.50	1170	4000	9.0	250	0.25	1300	4000	
F 20 3_ 172.6	16.2	250	0.46	1200	4000	8.1	250	0.23	1300	4000	
F 20 3_ 184.9	15.1	250	0.43	1210	4000	7.6	250	0.21	1300	4000	
F 20 3_ 209.3	13.4	250	0.38	1240	4000	6.7	250	0.19	1300	4000	
F 20 3_ 234.0	12.0	250	0.34	1270	4000	6.0	250	0.17	1300	4000	
F 20 3_ 255.3	11.0	250	0.31	1280	4000	5.5	250	0.15	1300	4000	
F 20 3_ 285.2	9.8	250	0.28	1300	4000	4.9	250	0.14	1300	4000	
F 20 3_ 316.9	8.8	250	0.25	1300	4000	4.4	250	0.12	1300	4000	
F 20 3_ 372.9	7.5	250	0.21	1300	4000	3.8	250	0.11	1300	4000	
F 20 3_ 419.3	6.7	250	0.19	1300	4000	3.3	250	0.09	1300	4000	
F 20 3_ 471.7	5.9	250	0.17	1300	4000	3.0	250	0.08	1300	4000	
F 20 3_ 545.3	5.1	250	0.14	1300	4000	2.6	250	0.07	1300	4000	

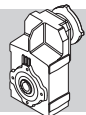

(-) Для получения точных сведений необходимо обратиться в отдел технической поддержки и сообщить данные о радиальной нагрузке (направление вращения вала, угол и расположение точки приложения нагрузки)



	i	n ₁ = 900 мин ⁻¹					n ₁ = 500 мин ⁻¹					
		n ₂ мин ⁻¹	M _{n2} Нм	P _{n1} кВт	R _{n1} Н	R _{n2} Н	n ₂ мин ⁻¹	M _{n2} Нм	P _{n1} кВт	R _{n1} Н	R _{n2} Н	
F 20 2_ 6.4		140	150	2.3	—	1990	218	183	4.4	—	2420	103
F 20 2_ 7.8		115	167	2.1	—	2110	64	189	1.3	—	2610	
F 20 2_ 8.7		103	180	2.0	—	2170	57	219	1.4	—	2640	
F 20 2_ 10.0		90	191	1.9	—	2260	50	221	1.2	—	2790	
F 20 2_ 11.2		80	205	1.8	—	2330	45	250	1.2	—	2830	
F 20 2_ 14.8		61	232	1.6	1210	2570	34	250	0.93	1790	3230	
F 20 2_ 18.1		50	250	1.4	1150	2740	28	250	0.76	1910	3500	
F 20 2_ 20.2		45	250	1.2	1320	2870	25	250	0.68	1960	3650	
F 20 2_ 23.1		39	250	1.1	1350	3040	22	250	0.60	1970	3860	
F 20 2_ 25.9		35	250	0.96	1500	3190	19	250	0.53	2010	4000	
F 20 2_ 30.4		30	250	0.82	1530	3400	16	250	0.45	2020	4000	
F 20 2_ 33.1		27	250	0.75	1580	3520	15	250	0.42	2040	4000	
F 20 2_ 37.9		24	250	0.65	1590	3720	13	250	0.36	2040	4000	
F 20 2_ 41.8		22	250	0.59	1610	3870	12	250	0.33	2070	4000	
F 20 2_ 44.8		20	250	0.55	1610	3970	11	250	0.31	2060	4000	
F 20 2_ 50.7		18	250	0.49	1640	4000	9.9	250	0.27	2090	4000	
F 20 2_ 56.7		16	250	0.44	1650	4000	8.8	250	0.24	2110	4000	
F 20 2_ 61.9		15	250	0.40	1660	4000	8.1	250	0.22	2110	4000	
F 20 2_ 69.1		13	250	0.36	1660	4000	7.2	250	0.20	2110	4000	
F 20 2_ 76.8		12	250	0.32	1670	4000	6.5	250	0.18	2120	4000	
F 20 2_ 90.4		10	250	0.27	1680	4000	5.5	250	0.15	2130	4000	
F 20 2_ 101.6		8.9	250	0.24	1680	4000	4.9	250	0.14	2130	4000	
F 20 2_ 114.3		7.9	250	0.22	1690	4000	4.4	250	0.12	2140	4000	
F 20 2_ 132.2		6.8	250	0.19	1690	4000	3.8	250	0.10	2150	4000	
F 20 3_ 156.3		5.8	250	0.16	1300	4000	3.2	250	0.09	1300	4000	
F 20 3_ 172.6		5.2	250	0.15	1300	4000	2.9	250	0.08	1300	4000	
F 20 3_ 184.9		4.9	250	0.14	1300	4000	2.7	250	0.08	1300	4000	
F 20 3_ 209.3		4.3	250	0.12	1300	4000	2.4	250	0.07	1300	4000	
F 20 3_ 234.0		3.8	250	0.11	1300	4000	2.1	250	0.06	1300	4000	
F 20 3_ 255.3		3.5	250	0.10	1300	4000	2.0	250	0.06	1300	4000	
F 20 3_ 285.2		3.2	250	0.09	1300	4000	1.8	250	0.05	1300	4000	
F 20 3_ 316.9		2.8	250	0.08	1300	4000	1.6	250	0.04	1300	4000	
F 20 3_ 372.9		2.4	250	0.07	1300	4000	1.3	250	0.04	1300	4000	
F 20 3_ 419.3		2.1	250	0.06	1300	4000	1.2	250	0.03	1300	4000	
F 20 3_ 471.7		1.9	250	0.05	1300	4000	1.1	250	0.03	1300	4000	
F 20 3_ 545.3		1.7	250	0.05	1300	4000	0.92	250	0.03	1300	4000	

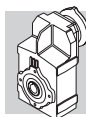

(-) Для получения точных сведений необходимо обратиться в отдел технической поддержки и сообщить данные о радиальной нагрузке (направление вращения вала, угол и расположение точки приложения нагрузки)

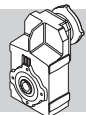

	i	n ₁ = 2800 мин ⁻¹					n ₁ = 1400 мин ⁻¹					
		n ₂ мин ⁻¹	M _{n2} Нм	P _{n1} кВт	R _{n1} Н	R _{n2} Н	n ₂ мин ⁻¹	M _{n2} Нм	P _{n1} кВт	R _{n1} Н	R _{n2} Н	
F 25 2_ 6.9		408	155	7.0	—	1840	204	195	4.4	—	2320	107
F 25 2_ 8.4		334	170	6.3	—	1950	167	215	4.0	—	2450	
F 25 2_ 9.4		299	180	5.9	—	2010	150	225	3.7	—	2540	
F 25 2_ 10.6		264	240	7.0	—	1850	132	305	4.4	—	2320	
F 25 2_ 13.0		216	255	6.1	—	1990	108	320	3.8	—	2510	
F 25 2_ 14.5		194	260	5.5	—	2080	97	330	3.5	—	2610	
F 25 2_ 16.6		168	270	5.0	—	2190	84	340	3.2	—	2760	
F 25 2_ 18.6		150	280	4.6	—	2270	75	350	2.9	—	2870	
F 25 2_ 21.8		128	280	4.0	—	2460	64	355	2.5	250	3090	
F 25 2_ 23.8		118	285	3.7	250	2540	59	360	2.3	300	3200	
F 25 2_ 27.2		103	290	3.3	250	2690	51	365	2.1	320	3400	
F 25 2_ 30.0		93	295	3.0	310	2800	47	370	1.9	410	3540	
F 25 2_ 32.2		87	295	2.8	310	2900	44	370	1.8	410	3660	
F 25 2_ 36.4		77	295	2.5	460	3070	38	370	1.6	600	3880	
F 25 2_ 40.7		69	295	2.2	560	3230	34	370	1.4	720	4080	
F 25 2_ 44.4		63	295	2.0	720	3360	32	370	1.3	720	4250	
F 25 3_ 45.6		61	340	2.4	1440	3100	31	400	1.4	1830	4030	
F 25 3_ 50.8		55	350	2.2	1450	3230	27.6	400	1.2	1850	4250	
F 25 3_ 58.3		48	365	2.0	1450	3390	24.0	400	1.1	1860	4530	
F 25 3_ 65.3		43	375	1.8	1450	3530	21.4	400	0.97	1870	4780	
F 25 3_ 76.6		37	395	1.6	1450	3730	18.3	400	0.82	1880	5140	
F 25 3_ 83.4		34	400	1.5	1450	3860	16.8	400	0.76	1880	5330	
F 25 3_ 95.5		29.3	400	1.3	1460	4130	14.7	400	0.66	1890	5660	
F 25 3_ 105.4		26.6	400	1.2	1470	4320	13.3	400	0.60	1890	5910	
F 25 3_ 113.0		24.8	400	1.1	1470	4470	12.4	400	0.56	1890	6090	
F 25 3_ 127.8		21.9	400	0.99	1480	4730	11.0	400	0.49	1900	6430	
F 25 3_ 143.0		19.6	400	0.88	1480	4980	9.8	400	0.44	1910	6500	
F 25 3_ 155.9		18.0	400	0.81	1480	5180	9.0	400	0.40	1910	6500	
F 25 3_ 174.2		16.1	400	0.72	1490	5440	8.0	400	0.36	1910	6500	
F 25 3_ 193.6		14.5	400	0.65	1490	5700	7.2	400	0.33	1910	6500	
F 25 3_ 227.8		12.3	400	0.55	1490	6120	6.1	400	0.28	1920	6500	
F 25 3_ 256.1		10.9	400	0.49	1490	6430	5.5	400	0.25	1920	6500	
F 25 3_ 288.1		9.7	400	0.44	1490	6500	4.9	400	0.22	1920	6500	
F 25 3_ 333.1		8.4	400	0.38	1500	6500	4.2	400	0.19	1930	6500	
F 25 4_ 393.9		7.1	400	0.33	1270	6500	3.6	400	0.17	1300	6500	
F 25 4_ 434.9		6.4	400	0.30	1290	6500	3.2	400	0.15	1300	6500	
F 25 4_ 466.0		6.0	400	0.28	1300	6500	3.0	400	0.14	1300	6500	
F 25 4_ 527.3		5.3	400	0.25	1300	6500	2.7	400	0.12	1300	6500	
F 25 4_ 589.7		4.7	400	0.22	1300	6500	2.4	400	0.11	1300	6500	
F 25 4_ 643.3		4.4	400	0.20	1300	6500	2.2	400	0.10	1300	6500	
F 25 4_ 718.7		3.9	400	0.18	1300	6500	1.9	400	0.09	1300	6500	
F 25 4_ 798.5		3.5	400	0.16	1300	6500	1.8	400	0.08	1300	6500	
F 25 4_ 939.8		3.0	400	0.14	1300	6500	1.5	400	0.07	1300	6500	
F 25 4_ 1057		2.7	400	0.12	1300	6500	1.3	400	0.06	1300	6500	
F 25 4_ 1189		2.4	400	0.11	1300	6500	1.2	400	0.05	1300	6500	
F 25 4_ 1374		2.0	400	0.09	1300	6500	1.0	400	0.05	1300	6500	

(-) Для получения точных сведений необходимо обратиться в отдел технической поддержки и сообщить данные о радиальной нагрузке (направление вращения вала, угол и расположение точки приложения нагрузки)



	i	n ₁ = 900 мин ⁻¹					n ₁ = 500 мин ⁻¹					
		n ₂ мин ⁻¹	M _{n2} Нм	P _{n1} кВт	R _{n1} Н	R _{n2} Н	n ₂ мин ⁻¹	M _{n2} Нм	P _{n1} кВт	R _{n1} Н	R _{n2} Н	
F 25 2_ 6.9		131	225	3.2	—	2690	73	255	2.0	370	3350	
F 25 2_ 8.4		107	250	3.0	—	2840	60	260	1.7	590	3630	
F 25 2_ 9.4		96	260	2.8	—	2940	53	265	1.6	820	3780	
F 25 2_ 10.6		85	355	3.3	—	2680	47	395	2.0	360	3420	
F 25 2_ 13.0		69	370	2.8	—	2910	39	400	1.7	620	3750	
F 25 2_ 14.5		62	380	2.6	—	3030	35	400	1.5	940	3950	
F 25 2_ 16.6		54	395	2.4	—	3190	30	400	1.3	1070	4210	
F 25 2_ 18.6		48	400	2.1	300	3350	26.9	400	1.2	1330	4440	
F 25 2_ 21.8		41	400	1.8	420	3630	22.9	400	1.0	1450	4770	
F 25 2_ 23.8		38	400	1.7	530	3780	21.0	400	0.93	1560	4950	
F 25 2_ 27.2		33	400	1.5	610	4030	18.4	400	0.81	1640	5260	
F 25 2_ 30.0		30	400	1.3	760	4220	16.6	400	0.73	1790	5490	
F 25 2_ 32.2		28.0	400	1.2	760	4360	15.5	400	0.69	1790	5660	
F 25 2_ 36.4		24.7	400	1.1	970	4610	13.7	400	0.61	2000	5970	
F 25 2_ 40.7		22.1	375	0.91	1330	4950	12.3	375	0.51	2000	6360	
F 25 2_ 44.4		20.3	385	0.86	1230	5100	11.3	385	0.48	2000	6500	
F 25 3_ 45.6		19.8	400	0.89	2160	4960	11.0	400	0.49	2200	6420	
F 25 3_ 50.8		17.7	400	0.80	2180	5210	9.8	400	0.44	2200	6500	
F 25 3_ 58.3		15.4	400	0.69	2190	5540	8.6	400	0.39	2200	6500	
F 25 3_ 65.3		13.8	400	0.62	2200	5820	7.7	400	0.34	2200	6500	
F 25 3_ 76.6		11.8	400	0.53	2200	6240	6.5	400	0.29	2200	6500	
F 25 3_ 83.4		10.8	400	0.49	2200	6470	6.0	400	0.27	2200	6500	
F 25 3_ 95.5		9.4	400	0.42	2200	6500	5.2	400	0.24	2200	6500	
F 25 3_ 105.4		8.5	400	0.38	2200	6500	4.7	400	0.21	2200	6500	
F 25 3_ 113.0		8.0	400	0.36	2200	6500	4.4	400	0.20	2200	6500	
F 25 3_ 127.8		7.0	400	0.32	2200	6500	3.9	400	0.18	2200	6500	
F 25 3_ 143.0		6.3	400	0.28	2200	6500	3.5	400	0.16	2200	6500	
F 25 3_ 155.9		5.8	400	0.26	2200	6500	3.2	400	0.14	2200	6500	
F 25 3_ 174.2		5.2	400	0.23	2200	6500	2.9	400	0.13	2200	6500	
F 25 3_ 193.6		4.6	400	0.21	2200	6500	2.6	400	0.12	2200	6500	
F 25 3_ 227.8		4.0	400	0.18	2200	6500	2.2	400	0.10	2200	6500	
F 25 3_ 256.1		3.5	400	0.16	2200	6500	2.0	400	0.09	2200	6500	
F 25 3_ 288.1		3.1	400	0.14	2200	6500	1.7	400	0.08	2200	6500	
F 25 3_ 333.1		2.7	400	0.12	2200	6500	1.5	400	0.07	2200	6500	
F 25 4_ 393.9		2.3	400	0.11	1300	6500	1.3	400	0.06	1300	6500	
F 25 4_ 434.9		2.1	400	0.10	1300	6500	1.1	400	0.05	1300	6500	
F 25 4_ 466.0		1.9	400	0.09	1300	6500	1.1	400	0.05	1300	6500	
F 25 4_ 527.3		1.7	400	0.08	1300	6500	0.95	400	0.04	1300	6500	
F 25 4_ 589.7		1.5	400	0.07	1300	6500	0.85	400	0.04	1300	6500	
F 25 4_ 643.3		1.4	400	0.07	1300	6500	0.78	400	0.04	1300	6500	
F 25 4_ 718.7		1.3	400	0.06	1300	6500	0.70	400	0.03	1300	6500	
F 25 4_ 798.5		1.1	400	0.05	1300	6500	0.63	400	0.03	1300	6500	
F 25 4_ 939.8		0.96	400	0.04	1300	6500	0.53	400	0.02	1300	6500	
F 25 4_ 1057		0.85	400	0.04	1300	6500	0.47	400	0.02	1300	6500	
F 25 4_ 1189		0.76	400	0.04	1300	6500	0.42	400	0.02	1300	6500	
F 25 4_ 1374		0.65	400	0.03	1300	6500	0.36	400	0.02	1300	6500	

107

(-) Для получения точных сведений необходимо обратиться в отдел технической поддержки и сообщить данные о радиальной нагрузке (направление вращения вала, угол и расположение точки приложения нагрузки)

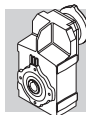

i	n ₁ = 2800 мин ⁻¹					n ₁ = 1400 мин ⁻¹					i
	n ₂ мин ⁻¹	M _{n2} Нм	P _{n1} кВт	R _{n1} Н	R _{n2} Н	n ₂ мин ⁻¹	M _{n2} Нм	P _{n1} кВт	R _{n1} Н	R _{n2} Н	
F 31 2_ 6.9	403	295	13.1	—	2710	201	360	8.0	—	3460	111
F 31 2_ 8.2	340	310	11.6	—	2880	170	375	7.0	—	3690	
F 31 2_ 9.0	311	310	10.6	—	3000	155	385	6.6	390	3810	
F 31 2_ 10.7	261	450	12.9	—	2790	130	525	7.5	500	3670	
F 31 2_ 12.7	220	475	11.5	—	2950	110	555	6.7	490	3880	
F 31 2_ 13.9	201	475	10.5	290	3100	100	570	6.3	650	4010	
F 31 2_ 16.8	167	475	8.7	510	3410	83	595	5.5	680	4310	
F 31 2_ 18.5	151	475	7.9	730	3580	76	600	5.0	910	4510	
F 31 2_ 21.1	133	475	6.9	830	3830	66	600	4.4	1030	4820	
F 31 2_ 23.4	120	475	6.3	1020	4020	60	600	4.0	1270	5060	
F 31 2_ 27.3	103	475	5.4	1100	4330	51	600	3.4	1380	5450	
F 31 2_ 30.1	93	475	4.9	1270	4540	46	600	3.1	1590	5710	
F 31 2_ 34.4	81	475	4.3	1330	4820	41	600	2.7	1660	6070	
F 31 2_ 37.7	74	475	3.9	1430	5030	37	600	2.5	1800	6330	
F 31 2_ 40.4	69	475	3.6	1440	5190	35	600	2.3	1800	6500	
F 31 2_ 44.6	63	475	3.3	1540	5430	31	600	2.1	1930	6500	
F 31 3_ 47.5	59	475	3.1	2110	5490	29.4	580	1.9	2200	6500	
F 31 3_ 52.1	54	485	2.9	2120	5680	26.9	600	1.8	2200	6500	
F 31 3_ 62.8	45	515	2.6	2120	6040	22.3	600	1.5	2200	6500	
F 31 3_ 69.1	41	530	2.4	2130	6250	20.3	600	1.4	2200	6500	
F 31 3_ 78.9	36	550	2.2	2120	6500	17.8	600	1.2	2200	6500	
F 31 3_ 87.4	32	570	2.1	2130	6500	16.0	600	1.1	2200	6500	
F 31 3_ 101.9	27.5	595	1.8	2130	6500	13.7	600	0.93	2200	6500	
F 31 3_ 112.5	24.9	600	1.7	2130	6500	12.4	600	0.84	2200	6500	
F 31 3_ 128.4	21.8	600	1.5	2140	6500	10.9	600	0.74	2200	6500	
F 31 3_ 140.7	19.9	600	1.3	2140	6500	9.9	600	0.67	2200	6500	
F 31 3_ 150.8	18.6	600	1.3	2140	6500	9.3	600	0.63	2200	6500	
F 31 3_ 166.8	16.8	600	1.1	2150	6500	8.4	600	0.57	2200	6500	
F 31 3_ 185.4	15.1	600	1.0	2160	6500	7.5	600	0.51	2200	6500	
F 31 3_ 202.3	13.8	600	0.94	2160	6500	6.9	600	0.47	2200	6500	
F 31 3_ 228.2	12.3	600	0.83	2160	6500	6.1	600	0.41	2200	6500	
F 31 3_ 253.6	11.0	600	0.75	2160	6500	5.5	600	0.37	2200	6500	
F 31 3_ 293.8	9.5	600	0.64	2170	6500	4.8	600	0.32	2200	6500	
F 31 3_ 332.8	8.4	600	0.57	2170	6500	4.2	600	0.28	2200	6500	
F 31 3_ 374.4	7.5	600	0.51	2170	6500	3.7	600	0.25	2200	6500	
F 31 4_ 418.9	6.7	600	0.47	1230	6500	3.3	600	0.23	1300	6500	
F 31 4_ 462.6	6.1	600	0.42	1250	6500	3.0	600	0.21	1300	6500	
F 31 4_ 527.8	5.3	600	0.37	1270	6500	2.7	600	0.19	1300	6500	
F 31 4_ 578.6	4.8	600	0.34	1290	6500	2.4	600	0.17	1300	6500	
F 31 4_ 619.9	4.5	600	0.32	1300	6500	2.3	600	0.16	1300	6500	
F 31 4_ 685.6	4.1	600	0.29	1300	6500	2.0	600	0.14	1300	6500	
F 31 4_ 762.3	3.7	600	0.26	1300	6500	1.8	600	0.13	1300	6500	
F 31 4_ 831.6	3.4	600	0.24	1300	6500	1.7	600	0.12	1300	6500	
F 31 4_ 938.2	3.0	600	0.21	1300	6500	1.5	600	0.10	1300	6500	
F 31 4_ 1042	2.7	600	0.19	1300	6500	1.3	600	0.09	1300	6500	
F 31 4_ 1208	2.3	600	0.16	1300	6500	1.2	600	0.08	1300	6500	
F 31 4_ 1368	2.0	600	0.14	1300	6500	1.0	600	0.07	1300	6500	
F 31 4_ 1539	1.8	600	0.13	1300	6500	0.91	600	0.06	1300	6500	

(-) Для получения точных сведений необходимо обратиться в отдел технической поддержки и сообщить данные о радиальной нагрузке (направление вращения вала, угол и расположение точки приложения нагрузки)

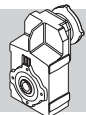

i	n ₁ = 900 мин ⁻¹					n ₁ = 500 мин ⁻¹					
	n ₂ мин ⁻¹	M _{n2} Нм	P _{n1} кВт	R _{n1} Н	R _{n2} Н	n ₂ мин ⁻¹	M _{n2} Нм	P _{n1} кВт	R _{n1} Н	R _{n2} Н	
F 31 2_ 6.9	130	390	5.6	640	4120	72	390	3.1	2200	5350	
F 31 2_ 8.2	109	390	4.7	990	4450	61	390	2.6	2200	5760	
F 31 2_ 9.0	100	390	4.3	1320	4640	55	390	2.4	2200	5980	
F 31 2_ 10.7	84	600	5.5	670	4280	47	600	3.1	2200	5710	
F 31 2_ 12.7	71	600	4.7	1020	4670	39	600	2.6	2200	6170	
F 31 2_ 13.9	65	600	4.3	1350	4880	36	600	2.4	2200	6440	
F 31 2_ 16.8	54	600	3.5	1640	5340	30	600	2.0	2200	6500	
F 31 2_ 18.5	49	600	3.2	1915	5580	27	600	1.8	2200	6500	
F 31 2_ 21.1	43	600	2.8	2040	5950	24	600	1.6	2200	6500	
F 31 2_ 23.4	38	600	2.5	2200	6230	21	600	1.4	2200	6500	
F 31 2_ 27.3	33	600	2.2	2200	6500	18	600	1.2	2200	6500	
F 31 2_ 30.1	30	600	2.0	2200	6500	17	600	1.1	2200	6500	
F 31 2_ 34.4	26	600	1.7	2200	6500	15	600	0.96	2200	6500	
F 31 2_ 37.7	24	600	1.6	2200	6500	13	600	0.88	2200	6500	
F 31 2_ 40.4	22	600	1.5	2200	6500	12	600	0.82	2200	6500	
F 31 2_ 44.6	20	600	1.3	2200	6500	11	600	0.74	2200	6500	
F 31 3_ 47.5	19	600	1.3	2200	6500	10.5	600	0.71	2200	6500	
F 31 3_ 52.1	17	600	1.2	2200	6500	9.6	600	0.65	2200	6500	
F 31 3_ 62.8	14	600	0.97	2200	6500	8.0	600	0.54	2200	6500	
F 31 3_ 69.1	13	600	0.88	2200	6500	7.2	600	0.49	2200	6500	
F 31 3_ 78.9	11	600	0.77	2200	6500	6.3	600	0.43	2200	6500	
F 31 3_ 87.4	10	600	0.70	2200	6500	5.7	600	0.39	2200	6500	
F 31 3_ 101.9	8.8	600	0.60	2200	6500	4.9	600	0.33	2200	6500	
F 31 3_ 112.5	8.0	600	0.54	2200	6500	4.4	600	0.30	2200	6500	
F 31 3_ 128.4	7.0	600	0.47	2200	6500	3.9	600	0.26	2200	6500	
F 31 3_ 140.7	6.4	600	0.43	2200	6500	3.6	600	0.24	2200	6500	
F 31 3_ 150.8	6.0	600	0.40	2200	6500	3.3	600	0.22	2200	6500	
F 31 3_ 166.8	5.4	600	0.36	2200	6500	3.0	600	0.20	2200	6500	
F 31 3_ 185.4	4.9	600	0.33	2200	6500	2.7	600	0.18	2200	6500	
F 31 3_ 202.3	4.4	600	0.30	2200	6500	2.5	600	0.17	2200	6500	
F 31 3_ 228.2	3.9	600	0.27	2200	6500	2.2	600	0.15	2200	6500	
F 31 3_ 253.6	3.5	600	0.24	2200	6500	2.0	600	0.13	2200	6500	
F 31 3_ 293.8	3.1	600	0.21	2200	6500	1.7	600	0.11	2200	6500	
F 31 3_ 332.8	2.7	600	0.18	2200	6500	1.5	600	0.10	2200	6500	
F 31 3_ 374.4	2.4	600	0.16	2200	6500	1.3	600	0.09	2200	6500	
F 31 4_ 418.9	2.1	600	0.15	1300	6500	1.2	600	0.08	1300	6500	
F 31 4_ 462.6	1.9	600	0.14	1300	6500	1.1	600	0.08	1300	6500	
F 31 4_ 527.8	1.7	600	0.12	1300	6500	0.95	600	0.07	1300	6500	
F 31 4_ 578.6	1.6	600	0.11	1300	6500	0.86	600	0.06	1300	6500	
F 31 4_ 619.9	1.5	600	0.10	1300	6500	0.81	600	0.06	1300	6500	
F 31 4_ 685.6	1.3	600	0.09	1300	6500	0.73	600	0.05	1300	6500	
F 31 4_ 762.3	1.2	600	0.08	1300	6500	0.66	600	0.05	1300	6500	
F 31 4_ 831.6	1.1	600	0.08	1300	6500	0.60	600	0.04	1300	6500	
F 31 4_ 938.2	0.96	600	0.07	1300	6500	0.53	600	0.04	1300	6500	
F 31 4_ 1042	0.86	600	0.06	1300	6500	0.48	600	0.03	1300	6500	
F 31 4_ 1208	0.75	600	0.05	1300	6500	0.41	600	0.03	1300	6500	
F 31 4_ 1368	0.66	600	0.05	1300	6500	0.37	600	0.03	1300	6500	
F 31 4_ 1539	0.58	600	0.04	1300	6500	0.32	600	0.02	1300	6500	

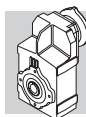

i	n ₁ = 2800 мин ⁻¹					n ₁ = 1400 мин ⁻¹					115
	n ₂ мин ⁻¹	M _{n2} Нм	P _{n1} кВт	R _{n1} Н	R _{n2} Н	n ₂ мин ⁻¹	M _{n2} Нм	P _{n1} кВт	R _{n1} Н	R _{n2} Н	
F 41 2_ 6.7	416	460	21.1	—	3410	208	580	13.3	—	4290	
F 41 2_ 9.1	306	515	17.4	—	3750	153	650	11.0	—	4730	
F 41 2_ 10.8	260	715	20.5	—	3310	130	900	12.9	—	4170	
F 41 2_ 14.6	191	805	17.0	—	3620	96	1015	10.7	—	4560	
F 41 2_ 17.1	164	835	15.1	—	3860	82	1055	9.5	—	4850	
F 41 2_ 18.9	148	860	14.0	410	4000	74	1085	8.9	500	5030	
F 41 2_ 24.1	116	875	11.2	650	4540	58	1100	7.0	840	5730	
F 41 2_ 30.1	93	875	9.0	980	5130	46	1100	5.6	1260	6470	
F 41 2_ 38.2	73	875	7.1	1260	5810	37	1100	4.4	1600	7330	
F 41 2_ 47.9	58	850	5.5	1680	6600	29.2	1070	3.4	2120	8320	
F 41 3_ 51.5	54	880	5.4	3030	6750	27.2	1085	3.3	3500	8500	
F 41 3_ 60.2	46	930	4.9	3030	7100	23.2	1100	2.9	3500	8500	
F 41 3_ 66.5	42	980	4.6	3030	7280	21.1	1100	2.6	3500	8500	
F 41 3_ 84.9	33	1065	4.0	3030	7890	16.5	1100	2.0	3500	8500	
F 41 3_ 106.0	26.4	1100	3.3	3040	8500	13.2	1100	1.6	3500	8500	
F 41 3_ 134.4	20.8	1100	2.6	3050	8500	10.4	1100	1.3	3500	8500	
F 41 3_ 168.7	16.6	1100	2.1	3070	8500	8.3	1100	1.0	3500	8500	
F 41 3_ 180.7	15.5	1100	1.9	3070	8500	7.7	1100	0.96	3500	8500	
F 41 3_ 198.9	14.1	1100	1.7	3080	8500	7.0	1100	0.87	3500	8500	
F 41 3_ 220.1	12.7	1100	1.6	3090	8500	6.4	1100	0.79	3500	8500	
F 41 3_ 240.1	11.7	1100	1.4	3090	8500	5.8	1100	0.72	3500	8500	
F 41 3_ 266.9	10.5	1100	1.3	3090	8500	5.2	1100	0.65	3500	8500	
F 41 3_ 296.6	9.4	1100	1.2	3090	8500	4.7	1100	0.58	3500	8500	
F 41 3_ 344.8	8.1	1100	1.0	3100	8500	4.1	1100	0.50	3500	8500	
F 41 4_ 433.7	6.5	1100	0.83	1480	8500	3.2	1100	0.41	1910	8500	
F 41 4_ 549.8	5.1	1100	0.65	1520	8500	2.5	1100	0.33	1940	8500	
F 41 4_ 690.1	4.1	1100	0.52	1540	8500	2.0	1100	0.26	1970	8500	
F 41 4_ 739.4	3.8	1100	0.48	1550	8500	1.9	1100	0.24	1980	8500	
F 41 4_ 813.8	3.4	1100	0.44	1560	8500	1.7	1100	0.22	1990	8500	
F 41 4_ 900.5	3.1	1100	0.40	1570	8500	1.6	1100	0.20	2000	8500	
F 41 4_ 982.4	2.9	1100	0.36	1570	8500	1.4	1100	0.18	2000	8500	
F 41 4_ 1092	2.6	1100	0.33	1580	8500	1.3	1100	0.16	2010	8500	
F 41 4_ 1213	2.3	1100	0.30	1590	8500	1.2	1100	0.15	2020	8500	
F 41 4_ 1411	2.0	1100	0.25	1600	8500	1.0	1100	0.13	2020	8500	

(-) Для получения точных сведений необходимо обратиться в отдел технической поддержки и сообщить данные о радиальной нагрузке (направление вращения вала, угол и расположение точки приложения нагрузки)

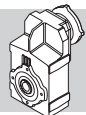

F 41

1100 Нм

i	n ₁ = 900 мин ⁻¹					n ₁ = 500 мин ⁻¹					
	n ₂ мин ⁻¹	M _{n2} Нм	P _{n1} кВт	R _{n1} Н	R _{n2} Н	n ₂ мин ⁻¹	M _{n2} Нм	P _{n1} кВт	R _{n1} Н	R _{n2} Н	
F 41 2_ 6.7	134	670	9.9	0	4980	74	700	5.7	1760	6450	115
F 41 2_ 9.1	99	700	7.6	680	5660	55	700	4.2	2850	7410	
F 41 2_ 10.8	84	1025	9.4	480	4900	46	1100	5.6	1950	6480	
F 41 2_ 14.6	62	1100	7.5	860	5550	34	1100	4.1	3030	7590	
F 41 2_ 17.1	53	1100	6.4	1230	6060	29.2	1100	3.5	3400	8210	
F 41 2_ 18.9	48	1100	5.8	1760	6390	26.5	1100	3.2	3500	8500	
F 41 2_ 24.1	37	1100	4.5	2210	7260	20.7	1100	2.5	3500	8500	
F 41 2_ 30.1	29.9	1100	3.6	2630	8120	16.6	1100	2.0	3500	8500	
F 41 2_ 38.2	23.6	1100	2.9	2970	8500	13.1	1100	1.6	3500	8500	
F 41 2_ 47.9	18.8	1070	2.2	3490	8500	10.4	1070	1.2	3500	8500	
F 41 3_ 51.5	17.5	1100	2.2	3500	8500	9.7	1100	1.2	3500	8500	
F 41 3_ 60.2	14.9	1100	1.9	3500	8500	8.3	1100	1.0	3500	8500	
F 41 3_ 66.5	13.5	1100	1.7	3500	8500	7.5	1100	0.93	3500	8500	
F 41 3_ 84.9	10.6	1100	1.3	3500	8500	5.9	1100	0.73	3500	8500	
F 41 3_ 106.0	8.5	1100	1.1	3500	8500	4.7	1100	0.58	3500	8500	
F 41 3_ 134.4	6.7	1100	0.83	3500	8500	3.7	1100	0.46	3500	8500	
F 41 3_ 168.7	5.3	1100	0.66	3500	8500	3.0	1100	0.37	3500	8500	
F 41 3_ 180.7	5.0	1100	0.62	3500	8500	2.8	1100	0.34	3500	8500	
F 41 3_ 198.9	4.5	1100	0.56	3500	8500	2.5	1100	0.31	3500	8500	
F 41 3_ 220.1	4.1	1100	0.51	3500	8500	2.3	1100	0.28	3500	8500	
F 41 3_ 240.1	3.7	1100	0.46	3500	8500	2.1	1100	0.26	3500	8500	
F 41 3_ 266.9	3.4	1100	0.42	3500	8500	1.9	1100	0.23	3500	8500	
F 41 3_ 296.6	3.0	1100	0.38	3500	8500	1.7	1100	0.21	3500	8500	
F 41 3_ 344.8	2.6	1100	0.32	3500	8500	1.5	1100	0.18	3500	8500	
F 41 4_ 433.7	2.1	1100	0.27	2200	8500	1.2	1100	0.15	2200	8500	
F 41 4_ 549.8	1.6	1100	0.21	2200	8500	0.91	1100	0.12	2200	8500	
F 41 4_ 690.1	1.3	1100	0.17	2200	8500	0.72	1100	0.09	2200	8500	
F 41 4_ 739.4	1.2	1100	0.16	2200	8500	0.68	1100	0.09	2200	8500	
F 41 4_ 813.8	1.1	1100	0.14	2200	8500	0.61	1100	0.08	2200	8500	
F 41 4_ 900.5	1.0	1100	0.13	2200	8500	0.56	1100	0.07	2200	8500	
F 41 4_ 982.4	0.92	1100	0.12	2200	8500	0.51	1100	0.07	2200	8500	
F 41 4_ 1092	0.82	1100	0.11	2200	8500	0.46	1100	0.06	2200	8500	
F 41 4_ 1213	0.74	1100	0.09	2200	8500	0.41	1100	0.05	2200	8500	
F 41 4_ 1411	0.64	1100	0.08	2200	8500	0.35	1100	0.05	2200	8500	

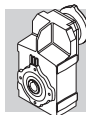

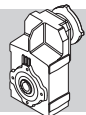

i	n ₁ = 2800 мин ⁻¹					n ₁ = 1400 мин ⁻¹					i
	n ₂ мин ⁻¹	M _{n2} Нм	P _{n1} кВт	R _{n1} Н	R _{n2} Н	n ₂ мин ⁻¹	M _{n2} Нм	P _{n1} кВт	R _{n1} Н	R _{n2} Н	
F 51 2_ 7.2	389	775	33.2	990	4170	195	975	20.9	1440	5260	119
F 51 2_ 9.1	309	875	29.8	890	4400	155	1100	18.8	1320	5550	
F 51 2_ 11.1	252	1055	29.3	1460	4530	126	1330	18.5	2010	5700	
F 51 2_ 14.0	200	1125	24.8	1580	4920	100	1420	15.7	2150	6200	
F 51 2_ 18.8	149	1225	20.1	1660	5480	74	1545	12.7	2240	6900	
F 51 2_ 23.8	118	1310	17.0	1710	5960	59	1650	10.7	2290	7520	
F 51 2_ 30.0	93	1350	13.9	1760	6610	47	1700	8.7	2330	8340	
F 51 2_ 37.1	75	1350	11.2	1910	7350	38	1700	7.1	2410	9260	
F 51 3_ 48.9	57	1505	9.7	2600	7800	28.6	1800	5.8	3310	10100	
F 51 3_ 65.8	43	1650	7.9	2610	8640	21.3	1800	4.3	3380	11600	
F 51 3_ 83.2	34	1770	6.7	2630	9380	16.8	1800	3.4	3440	12000	
F 51 3_ 105.1	26.6	1800	5.4	2650	10400	13.3	1800	2.7	3460	12000	
F 51 3_ 129.9	21.6	1800	4.4	2670	11600	10.8	1800	2.2	3490	12000	
F 51 3_ 165.6	16.9	1800	3.4	2700	12000	8.5	1800	1.7	3500	12000	
F 51 3_ 202.4	13.8	1800	2.8	2710	12000	6.9	1800	1.4	3500	12000	
F 51 3_ 216.9	12.9	1800	2.6	2710	12000	6.5	1800	1.3	3500	12000	
F 51 3_ 239.8	11.7	1800	2.4	2730	12000	5.8	1800	1.2	3500	12000	
F 51 3_ 262.1	10.7	1800	2.2	2730	12000	5.3	1800	1.1	3500	12000	
F 51 3_ 285.9	9.8	1800	2.0	2730	12000	4.9	1800	0.99	3500	12000	
F 51 3_ 317.3	8.8	1800	1.8	2740	12000	4.4	1800	0.89	3500	12000	
F 51 3_ 352.5	7.9	1800	1.6	2740	12000	4.0	1800	0.80	3500	12000	
F 51 4_ 429.1	6.5	1800	1.4	1930	12000	3.3	1800	0.68	2200	12000	
F 51 4_ 530.5	5.3	1800	1.1	1970	12000	2.6	1800	0.55	2200	12000	
F 51 4_ 676.3	4.1	1800	0.87	2020	12000	2.1	1800	0.43	2200	12000	
F 51 4_ 826.4	3.4	1800	0.71	2040	12000	1.7	1800	0.35	2200	12000	
F 51 4_ 885.5	3.2	1800	0.66	2050	12000	1.6	1800	0.33	2200	12000	
F 51 4_ 979.4	2.9	1800	0.60	2060	12000	1.4	1800	0.30	2200	12000	
F 51 4_ 1070	2.6	1800	0.55	2070	12000	1.3	1800	0.27	2200	12000	
F 51 4_ 1168	2.4	1800	0.50	2080	12000	1.2	1800	0.25	2200	12000	
F 51 4_ 1296	2.2	1800	0.45	2090	12000	1.1	1800	0.23	2200	12000	
F 51 4_ 1439	1.9	1800	0.41	2100	12000	1.0	1800	0.20	2200	12000	





F 51

1800 Нм

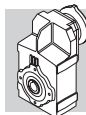

	i	n ₁ = 900 мин ⁻¹					n ₁ = 500 мин ⁻¹					
		n ₂ мин ⁻¹	M _{n2} Нм	P _{n1} кВт	R _{n1} Н	R _{n2} Н	n ₂ мин ⁻¹	M _{n2} Нм	P _{n1} кВт	R _{n1} Н	R _{n2} Н	
F 51 2_ 7.2		125	1100	15.2	1940	6170	69.5	1100	8.4	3190	8140	119
F 51 2_ 9.1		99	1100	12.1	2450	6900	55.2	1100	6.7	3440	9030	
F 51 2_ 11.1		81	1520	13.6	2450	6660	45.0	1700	8.4	3190	8480	
F 51 2_ 14.0		64	1620	11.5	2550	7250	35.8	1700	6.7	3440	9500	
F 51 2_ 18.8		48	1700	9.0	2690	8230	26.6	1700	5.0	3500	10900	
F 51 2_ 23.8		38	1700	7.1	2870	9250	21.0	1700	3.9	3500	12000	
F 51 2_ 30.0		30.0	1700	5.6	2960	10300	16.6	1700	3.1	3500	12000	
F 51 2_ 37.1		24.2	1700	4.5	3040	11400	13.5	1700	2.5	3500	12000	
F 51 3_ 48.9		18.4	1800	3.7	3500	12000	10.2	1800	2.1	3500	12000	
F 51 3_ 65.8		13.7	1800	2.8	3500	12000	7.6	1800	1.5	3500	12000	
F 51 3_ 83.2		10.8	1800	2.2	3500	12000	6.0	1800	1.2	3500	12000	
F 51 3_ 105.1		8.6	1800	1.7	3500	12000	4.8	1800	0.96	3500	12000	
F 51 3_ 129.9		6.9	1800	1.4	3500	12000	3.8	1800	0.78	3500	12000	
F 51 3_ 165.6		5.4	1800	1.1	3500	12000	3.0	1800	0.61	3500	12000	
F 51 3_ 202.4		4.4	1800	0.90	3500	12000	2.5	1800	0.50	3500	12000	
F 51 3_ 216.9		4.2	1800	0.84	3500	12000	2.3	1800	0.47	3500	12000	
F 51 3_ 239.8		3.8	1800	0.76	3500	12000	2.1	1800	0.42	3500	12000	
F 51 3_ 262.1		3.4	1800	0.70	3500	12000	1.9	1800	0.39	3500	12000	
F 51 3_ 285.9		3.1	1800	0.64	3500	12000	1.7	1800	0.35	3500	12000	
F 51 3_ 317.3		2.8	1800	0.57	3500	12000	1.6	1800	0.32	3500	12000	
F 51 3_ 352.5		2.6	1800	0.52	3500	12000	1.4	1800	0.29	3500	12000	
F 51 4_ 429.1		2.1	1800	0.44	2200	12000	1.2	1800	0.24	2200	12000	
F 51 4_ 530.5		1.7	1800	0.36	2200	12000	0.94	1800	0.20	2200	12000	
F 51 4_ 676.3		1.3	1800	0.28	2200	12000	0.74	1800	0.15	2200	12000	
F 51 4_ 826.4		1.1	1800	0.23	2200	12000	0.61	1800	0.13	2200	12000	
F 51 4_ 885.5		1.0	1800	0.21	2200	12000	0.56	1800	0.12	2200	12000	
F 51 4_ 979.4		0.92	1800	0.19	2200	12000	0.51	1800	0.11	2200	12000	
F 51 4_ 1070		0.84	1800	0.18	2200	12000	0.47	1800	0.10	2200	12000	
F 51 4_ 1168		0.77	1800	0.16	2200	12000	0.43	1800	0.09	2200	12000	
F 51 4_ 1296		0.69	1800	0.15	2200	12000	0.39	1800	0.08	2200	12000	
F 51 4_ 1439		0.63	1800	0.13	2200	12000	0.35	1800	0.07	2200	12000	

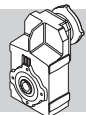

	i	n ₁ = 2800 мин ⁻¹					n ₁ = 1400 мин ⁻¹					
		n ₂ мин ⁻¹	M _{n2} Нм	P _{n1} кВт	R _{n1} Н	R _{n2} Н	n ₂ мин ⁻¹	M _{n2} Нм	P _{n1} кВт	R _{n1} Н	R _{n2} Н	
F 60 3_ 9.0		311	920	32	—	13270	156	1160	20	—	16530	123
F 60 3_ 9.7		289	1000	33	—	13620	144	1250	20	—	16720	
F 60 3_ 11.8		237	1030	28	—	14550	119	1300	17.4	—	17840	
F 60 3_ 12.7		220	1110	28	—	14710	110	1400	17.4	—	18030	
F 60 3_ 14.5		193	1110	24	—	15450	97	1400	15.3	—	18950	
F 60 3_ 15.7		178	1200	24	—	15620	89	1500	15.1	—	19170	
F 60 3_ 19.1		147	1200	20	—	16800	73	1500	12.4	—	20000	
F 60 3_ 20.7		135	1300	20	—	16970	68	1640	12.5	—	20000	
F 60 3_ 23.5		119	1260	17	—	17920	60	1590	10.7	—	20000	
F 60 3_ 25.4		110	1370	17	—	18090	55	1720	10.7	—	20000	
F 60 3_ 29.6		95	2750	29	820	15920	47	2900	15.5	2630	20000	
F 60 3_ 32.1		87	2800	28	1290	16200	44	2900	14.3	3260	20000	
F 60 3_ 38.8		72	2900	24	1260	17480	36	2900	11.8	3480	20000	
F 60 3_ 42.1		67	2900	22	1820	17910	33	2900	10.9	3720	20000	
F 60 3_ 47.8		59	2900	19.2	1770	19050	29.3	2900	9.6	3730	20000	
F 60 3_ 51.8		54	2900	17.7	2290	19530	27.0	2900	8.9	3830	20000	
F 60 3_ 63.0		44	2900	14.6	2310	20000	22.2	2900	7.3	3850	20000	
F 60 3_ 68.3		41	2900	13.4	2790	20000	20.5	2900	6.7	3940	20000	
F 60 3_ 77.6		36	2900	11.8	2620	20000	18.0	2900	5.9	3920	20000	
F 60 3_ 84.0		33	2900	10.9	2960	20000	16.7	2900	5.5	4010	20000	
F 60 3_ 98.2		28.5	2900	9.3	2910	20000	14.3	2900	4.7	3980	20000	
F 60 3_ 106.4		26.3	2900	8.6	3020	20000	13.2	2900	4.3	4070	20000	
F 60 3_ 120.5		23.2	2900	7.6	2970	20000	11.6	2900	3.8	4030	20000	
F 60 3_ 130.5		21.5	2900	7.0	3060	20000	10.7	2900	3.5	4110	20000	
F 60 3_ 150.4		18.6	2900	6.1	3010	20000	9.3	2900	3.0	4060	20000	
F 60 3_ 162.9		17.2	2900	5.6	3090	20000	8.6	2900	2.8	4140	20000	
F 60 3_ 185.9		15.1	2900	4.9	3050	20000	7.5	2900	2.5	4100	20000	
F 60 3_ 201.4		13.9	2900	4.6	3130	20000	7.0	2900	2.3	4180	20000	
F 60 3_ 217.6		12.9	2900	4.2	3070	20000	6.4	2900	2.1	4120	20000	
F 60 3_ 235.8		11.9	2900	3.9	3140	20000	5.9	2900	1.9	4190	20000	
F 60 3_ 259.1		10.8	2900	3.5	3080	20000	5.4	2900	1.8	4130	20000	
F 60 3_ 280.7		10.0	2900	3.3	3150	20000	5.0	2900	1.6	4200	20000	
F 60 4_ 315.4		8.9	2900	3.0	3500	20000	4.4	2900	1.5	3500	20000	
F 60 4_ 341.7		8.2	2900	2.8	3500	20000	4.1	2900	1.4	3500	20000	
F 60 4_ 399.3		7.0	2900	2.4	3500	20000	3.5	2900	1.2	3500	20000	
F 60 4_ 432.6		6.5	2900	2.2	3500	20000	3.2	2900	1.1	3500	20000	
F 60 4_ 489.8		5.7	2900	1.9	3500	20000	2.9	2900	0.96	3500	20000	
F 60 4_ 530.7		5.3	2900	1.8	3500	20000	2.6	2900	0.89	3500	20000	
F 60 4_ 611.4		4.6	2900	1.5	3500	20000	2.3	2900	0.77	3500	20000	
F 60 4_ 662.4		4.2	2900	1.4	3500	20000	2.1	2900	0.71	3500	20000	
F 60 4_ 756.0		3.7	2900	1.2	3500	20000	1.9	2900	0.62	3500	20000	
F 60 4_ 819.0		3.4	2900	1.1	3500	20000	1.7	2900	0.57	3500	20000	
F 60 4_ 885.1		3.2	2900	1.1	3500	20000	1.6	2900	0.53	3500	20000	
F 60 4_ 958.9		2.9	2900	0.98	3500	20000	1.5	2900	0.49	3500	20000	
F 60 4_ 1054		2.7	2900	0.89	3500	20000	1.3	2900	0.45	3500	20000	
F 60 4_ 1141		2.5	2900	0.83	3500	20000	1.2	2900	0.41	3500	20000	

(-) Для получения точных сведений необходимо обратиться в отдел технической поддержки и сообщить данные о радиальной нагрузке (направление вращения вала, угол и расположение точки приложения нагрузки)

**F 60****2900 Нм**

	i	n ₁ = 900 мин ⁻¹					n ₁ = 500 мин ⁻¹					
		n ₂ мин ⁻¹	M _{n2} Нм	P _{n1} кВт	R _{n1} Н	R _{n2} Н	n ₂ мин ⁻¹	M _{n2} Нм	P _{n1} кВт	R _{n1} Н	R _{n2} Н	
F 60 3_ 9.0	100	1340	15.1	—	18840	56	1630	10.2	—	20000	123	
F 60 3_ 9.7	93	1460	15.3	—	19010	52	1780	10.4	—	20000		
F 60 3_ 11.8	76	1500	12.9	—	20000	42	1830	8.8	—	20000		
F 60 3_ 12.7	71	1620	13.0	—	20000	39	1900	8.4	600	20000		
F 60 3_ 14.5	62	1620	11.4	—	20000	34	1900	7.4	490	20000		
F 60 3_ 15.7	57	1750	11.3	—	20000	32	1900	6.8	1630	20000		
F 60 3_ 19.1	47	1750	9.3	—	20000	26.2	1900	5.6	1660	20000		
F 60 3_ 20.7	43	1900	9.3	—	20000	24.2	1900	5.2	2700	20000		
F 60 3_ 23.5	38	1840	8.0	—	20000	21.3	1900	4.6	2340	20000		
F 60 3_ 25.4	35	1900	7.6	620	20000	19.7	1900	4.2	3330	20000		
F 60 3_ 29.6	30	2900	10.0	4220	20000	16.9	2900	5.5	4700	20000		
F 60 3_ 32.1	28.0	2900	9.2	4350	20000	15.6	2900	5.1	4700	20000		
F 60 3_ 38.8	23.2	2900	7.6	4420	20000	12.9	2900	4.2	4700	20000		
F 60 3_ 42.1	21.4	2900	7.0	4530	20000	11.9	2900	3.9	4700	20000		
F 60 3_ 47.8	18.8	2900	6.2	4530	20000	10.5	2900	3.4	4700	20000		
F 60 3_ 51.8	17.4	2900	5.7	4640	20000	9.7	2900	3.2	4700	20000		
F 60 3_ 63.0	14.3	2900	4.7	4660	20000	7.9	2900	2.6	4700	20000		
F 60 3_ 68.3	13.2	2900	4.3	4700	20000	7.3	2900	2.4	4700	20000		
F 60 3_ 77.6	11.6	2900	3.8	4700	20000	6.4	2900	2.1	4700	20000		
F 60 3_ 84.0	10.7	2900	3.5	4700	20000	6.0	2900	1.9	4700	20000		
F 60 3_ 98.2	9.2	2900	3.0	4700	20000	5.1	2900	1.7	4700	20000		
F 60 3_ 106.4	8.5	2900	2.8	4700	20000	4.7	2900	1.5	4700	20000		
F 60 3_ 120.5	7.5	2900	2.4	4700	20000	4.1	2900	1.4	4700	20000		
F 60 3_ 130.5	6.9	2900	2.3	4700	20000	3.8	2900	1.3	4700	20000		
F 60 3_ 150.4	6.0	2900	2.0	4700	20000	3.3	2900	1.1	4700	20000		
F 60 3_ 162.9	5.5	2900	1.8	4700	20000	3.1	2900	1.0	4700	20000		
F 60 3_ 185.9	4.8	2900	1.6	4700	20000	2.7	2900	0.88	4700	20000		
F 60 3_ 201.4	4.5	2900	1.5	4700	20000	2.5	2900	0.81	4700	20000		
F 60 3_ 217.6	4.1	2900	1.4	4700	20000	2.3	2900	0.75	4700	20000		
F 60 3_ 235.8	3.8	2900	1.3	4700	20000	2.1	2900	0.69	4700	20000		
F 60 3_ 259.1	3.5	2900	1.1	4700	20000	1.9	2900	0.63	4700	20000		
F 60 3_ 280.7	3.2	2900	1.1	4700	20000	1.8	2900	0.58	4700	20000		
F 60 4_ 315.4	2.9	2900	0.96	3500	20000	1.6	2900	0.53	3500	20000		
F 60 4_ 341.7	2.6	2900	0.89	3500	20000	1.5	2900	0.49	3500	20000		
F 60 4_ 399.3	2.3	2900	0.76	3500	20000	1.3	2900	0.42	3500	20000		
F 60 4_ 432.6	2.1	2900	0.70	3500	20000	1.2	2900	0.39	3500	20000		
F 60 4_ 489.8	1.8	2900	0.62	3500	20000	1.0	2900	0.34	3500	20000		
F 60 4_ 530.7	1.7	2900	0.57	3500	20000	0.94	2900	0.32	3500	20000		
F 60 4_ 611.4	1.5	2900	0.50	3500	20000	0.82	2900	0.28	3500	20000		
F 60 4_ 662.4	1.4	2900	0.46	3500	20000	0.75	2900	0.25	3500	20000		
F 60 4_ 756.0	1.2	2900	0.40	3500	20000	0.66	2900	0.22	3500	20000		
F 60 4_ 819.0	1.1	2900	0.37	3500	20000	0.61	2900	0.21	3500	20000		
F 60 4_ 885.1	1.0	2900	0.34	3500	20000	0.56	2900	0.19	3500	20000		
F 60 4_ 958.9	0.94	2900	0.32	3500	20000	0.52	2900	0.18	3500	20000		
F 60 4_ 1054	0.85	2900	0.29	3500	20000	0.47	2900	0.16	3500	20000		
F 60 4_ 1141	0.79	2900	0.27	3500	20000	0.44	2900	0.15	3500	20000		

(-) Для получения точных сведений необходимо обратиться в отдел технической поддержки и сообщить данные о радиальной нагрузке (направление вращения вала, угол и расположение точки приложения нагрузки)

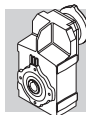

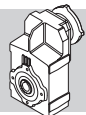

	i	n ₁ = 2800 мин ⁻¹					n ₁ = 1400 мин ⁻¹					
		n ₂ мин ⁻¹	M _{n2} Нм	P _{n1} кВт	R _{n1} Н	R _{n2} Н	n ₂ мин ⁻¹	M _{n2} Нм	P _{n1} кВт	R _{n1} Н	R _{n2} Н	
F 70 3_ 10.0		280	2600	82	1410	14770	140	3200	51	1750	18190	127
F 70 3_ 10.9		257	2800	81	1510	14710	128	3450	50	1840	18110	
F 70 3_ 12.8		219	2900	72	860	15710	109	3600	44	880	19280	
F 70 3_ 13.9		201	3150	72	810	15570	101	3900	44	880	19120	
F 70 3_ 16.3		172	3250	63	570	16630	86	4000	39	710	20480	
F 70 3_ 17.7		158	3550	63	430	16400	79	4350	39	630	20240	
F 70 3_ 20.9		134	3450	52	690	17990	67	4000	30	2090	22650	
F 70 3_ 22.6		124	3750	52	640	17800	62	4350	30	2010	22470	
F 70 3_ 24.6		114	3550	46	560	19040	57	4000	26	2510	24180	
F 70 3_ 27.7		101	3750	43	5070	19600	51	4650	27	6410	24060	
F 70 3_ 30.0		93	4050	43	5080	19440	47	5000	26	6420	23910	
F 70 3_ 35.4		79	4150	37	5070	20880	40	5000	22	6440	25930	
F 70 3_ 38.4		73	4500	37	5060	20650	36	5000	21	6540	26540	
F 70 3_ 45.2		62	4600	32	5080	22180	31	5000	17.5	6590	28650	
F 70 3_ 49.0		57	4600	30	5170	22710	28.6	5000	16.1	6680	29320	
F 70 3_ 57.7		49	5000	27	5090	23760	24.3	5000	13.7	6680	31570	
F 70 3_ 62.5		45	5000	25	5170	24330	22.4	5000	12.7	6760	32310	
F 70 3_ 67.9		41	5000	23	5110	25460	20.6	5000	11.6	6710	33640	
F 70 3_ 73.6		38	5000	21	5190	26070	19.0	5000	10.7	6790	34420	
F 70 3_ 85.4		33	5000	18.5	5190	27990	16.4	5000	9.3	6780	35000	
F 70 3_ 92.5		30	5000	17.1	5260	28650	15.1	5000	8.5	6860	35000	
F 70 3_ 101.2		27.7	5000	15.6	5220	29970	13.8	5000	7.8	6820	35000	
F 70 3_ 109.6		25.5	5000	14.4	5290	30670	12.8	5000	7.2	6890	35000	
F 70 3_ 122.7		22.8	5000	12.9	5250	32340	11.4	5000	6.4	6850	35000	
F 70 3_ 133.0		21.1	5000	11.9	5320	33100	10.5	5000	5.9	6920	35000	
F 70 3_ 153.8		18.2	5000	10.3	5280	35000	9.1	5000	5.1	6880	35000	
F 70 3_ 166.7		16.8	5000	9.5	5350	35000	8.4	5000	4.7	6950	35000	
F 70 3_ 180.9		15.5	5000	8.7	5310	35000	7.7	5000	4.4	6910	35000	
F 70 3_ 196.0		14.3	5000	8.1	5370	35000	7.1	5000	4.0	6970	35000	
F 70 4_ 216.5		12.9	5000	7.5	2130	35000	6.5	5000	3.7	2860	35000	
F 70 4_ 234.6		11.9	5000	6.9	2130	35000	6.0	5000	3.5	2860	35000	
F 70 4_ 280.9		10.0	5000	5.8	2200	35000	5.0	5000	2.9	2940	35000	
F 70 4_ 304.3		9.2	5000	5.3	2200	35000	4.6	5000	2.7	2940	35000	
F 70 4_ 372.5		7.5	5000	4.4	2260	35000	3.8	5000	2.2	3000	35000	
F 70 4_ 403.5		6.9	5000	4.0	2260	35000	3.5	5000	2.0	3000	35000	
F 70 4_ 471.2		5.9	5000	3.4	2300	35000	3.0	5000	1.7	3040	35000	
F 70 4_ 510.4		5.5	5000	3.2	2300	35000	2.7	5000	1.6	3040	35000	
F 70 4_ 606.8		4.6	5000	2.7	2340	35000	2.3	5000	1.3	3070	35000	
F 70 4_ 657.4		4.3	5000	2.5	2340	35000	2.1	5000	1.2	3070	35000	
F 70 4_ 759.0		3.7	5000	2.1	2360	35000	1.8	5000	1.1	3090	35000	
F 70 4_ 822.2		3.4	5000	2.0	2360	35000	1.7	5000	1.0	3090	35000	
F 70 4_ 899.4		3.1	5000	1.8	2370	35000	1.6	5000	0.90	3110	35000	
F 70 4_ 974.4		2.9	5000	1.7	2370	35000	1.4	5000	0.83	3110	35000	
F 70 4_ 1091		2.6	5000	1.5	2390	35000	1.3	5000	0.74	3120	35000	
F 70 4_ 1182		2.4	5000	1.4	2390	35000	1.2	5000	0.69	3120	35000	
F 70 4_ 1368		2.0	5000	1.2	2400	35000	1.0	5000	0.59	3130	35000	
F 70 4_ 1481		1.9	5000	1.1	2400	35000	0.95	5000	0.55	3130	35000	
F 70 4_ 1585		1.8	5000	1.0	2410	35000	0.88	5000	0.51	3140	35000	
F 70 4_ 1717		1.6	5000	0.95	2410	35000	0.82	5000	0.47	3140	35000	
F 70 4_ 2019		1.4	5000	0.80	2420	35000	0.69	5000	0.40	3150	35000	
F 70 4_ 2188		1.3	5000	0.74	2420	35000	0.64	5000	0.37	3150	35000	





F 70

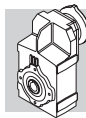

5000 Нм

	i	n ₁ = 900 мин ⁻¹					n ₁ = 500 мин ⁻¹					
		n ₂ мин ⁻¹	M _{n2} Нм	P _{n1} кВт	R _{n1} Н	R _{n2} Н	n ₂ мин ⁻¹	M _{n2} Нм	P _{n1} кВт	R _{n1} Н	R _{n2} Н	
F 70 3_ 10.0	90	3200	33	4870	21660	50	3200	18.1	7000	27010	127	
F 70 3_ 10.9	83	3450	32	4970	21670	46	3450	17.9	7000	27160		
F 70 3_ 12.8	70	3850	31	2540	22530	39	3600	15.9	7000	28320		
F 70 3_ 13.9	65	4200	31	2380	22350	36	3900	15.8	7000	28290		
F 70 3_ 16.3	55	4000	25	3830	24520	31	4000	13.9	7000	30730		
F 70 3_ 17.7	51	4350	25	3750	24380	28	4350	13.9	7000	30760		
F 70 3_ 20.9	43	4000	19.5	5210	26970	23.9	4000	10.8	7000	33650		
F 70 3_ 22.6	40	4350	19.6	5130	26900	22.1	4350	10.9	7000	33750		
F 70 3_ 24.6	37	4000	16.5	5630	28710	20.3	4000	9.2	7000	35000		
F 70 3_ 27.7	32	5000	18.4	7000	28090	18.1	4650	9.5	7000	35000		
F 70 3_ 30.0	30	5000	16.9	7000	28750	16.7	5000	9.4	7000	35000		
F 70 3_ 35.4	25.4	5000	14.4	7000	31010	14.1	5000	8.0	7000	35000		
F 70 3_ 38.4	23.4	5000	13.2	7000	31740	13.0	5000	7.4	7000	35000		
F 70 3_ 45.2	19.9	5000	11.2	7000	34090	11.1	5000	6.2	7000	35000		
F 70 3_ 49.0	18.4	5000	10.4	7000	34890	10.2	5000	5.8	7000	35000		
F 70 3_ 57.7	15.6	5000	8.8	7000	35000	8.7	5000	4.9	7000	35000		
F 70 3_ 62.5	14.4	5000	8.1	7000	35000	8.0	5000	4.5	7000	35000		
F 70 3_ 67.9	13.3	5000	7.5	7000	35000	7.4	5000	4.2	7000	35000		
F 70 3_ 73.6	12.2	5000	6.9	7000	35000	6.8	5000	3.8	7000	35000		
F 70 3_ 85.4	10.5	5000	6.0	7000	35000	5.9	5000	3.3	7000	35000		
F 70 3_ 92.5	9.7	5000	5.5	7000	35000	5.4	5000	3.1	7000	35000		
F 70 3_ 101.2	8.9	5000	5.0	7000	35000	4.9	5000	2.8	7000	35000		
F 70 3_ 109.6	8.2	5000	4.6	7000	35000	4.6	5000	2.6	7000	35000		
F 70 3_ 122.7	7.3	5000	4.1	7000	35000	4.1	5000	2.3	7000	35000		
F 70 3_ 133.0	6.8	5000	3.8	7000	35000	3.8	5000	2.1	7000	35000		
F 70 3_ 153.8	5.9	5000	3.3	7000	35000	3.3	5000	1.8	7000	35000		
F 70 3_ 166.7	5.4	5000	3.0	7000	35000	3.0	5000	1.7	7000	35000		
F 70 3_ 180.9	5.0	5000	2.8	7000	35000	2.8	5000	1.6	7000	35000		
F 70 3_ 196.0	4.6	5000	2.6	7000	35000	2.6	5000	1.4	7000	35000		
F 70 4_ 216.5	4.2	5000	2.4	3430	35000	2.3	5000	1.3	3500	35000		
F 70 4_ 234.6	3.8	5000	2.2	3430	35000	2.1	5000	1.2	3500	35000		
F 70 4_ 280.9	3.2	5000	1.9	3500	35000	1.8	5000	1.0	3500	35000		
F 70 4_ 304.3	3.0	5000	1.7	3500	35000	1.6	5000	0.95	3500	35000		
F 70 4_ 372.5	2.4	5000	1.4	3500	35000	1.3	5000	0.78	3500	35000		
F 70 4_ 403.5	2.2	5000	1.3	3500	35000	1.2	5000	0.72	3500	35000		
F 70 4_ 471.2	1.9	5000	1.1	3500	35000	1.1	5000	0.62	3500	35000		
F 70 4_ 510.4	1.8	5000	1.0	3500	35000	0.98	5000	0.57	3500	35000		
F 70 4_ 606.8	1.5	5000	0.86	3500	35000	0.82	5000	0.48	3500	35000		
F 70 4_ 657.4	1.4	5000	0.79	3500	35000	0.76	5000	0.44	3500	35000		
F 70 4_ 759.0	1.2	5000	0.69	3500	35000	0.66	5000	0.38	3500	35000		
F 70 4_ 822.2	1.1	5000	0.63	3500	35000	0.61	5000	0.35	3500	35000		
F 70 4_ 899.4	1.0	5000	0.58	3500	35000	0.56	5000	0.32	3500	35000		
F 70 4_ 974.4	0.92	5000	0.54	3500	35000	0.51	5000	0.30	3500	35000		
F 70 4_ 1091	0.82	5000	0.48	3500	35000	0.46	5000	0.27	3500	35000		
F 70 4_ 1182	0.76	5000	0.44	3500	35000	0.42	5000	0.25	3500	35000		
F 70 4_ 1368	0.66	5000	0.38	3500	35000	0.37	5000	0.21	3500	35000		
F 70 4_ 1481	0.61	5000	0.35	3500	35000	0.34	5000	0.20	3500	35000		
F 70 4_ 1585	0.57	5000	0.33	3500	35000	0.32	5000	0.18	3500	35000		
F 70 4_ 1717	0.52	5000	0.30	3500	35000	0.29	5000	0.17	3500	35000		
F 70 4_ 2019	0.45	5000	0.26	3500	35000	0.25	5000	0.14	3500	35000		
F 70 4_ 2188	0.41	5000	0.24	3500	35000	0.23	5000	0.13	3500	35000		

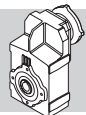

	i	n ₁ = 2800 мин ⁻¹					n ₁ = 1400 мин ⁻¹					
		n ₂ мин ⁻¹	M _{n2} Нм	P _{n1} кВт	R _{n1} Н	R _{n2} Н	n ₂ мин ⁻¹	M _{n2} Нм	P _{n1} кВт	R _{n1} Н	R _{n2} Н	
F 80 3_ 10.3		272	3250	100	610	17240	136	4100	63	220	21750	130
F 80 3_ 11.2		250	3520	99	620	17760	125	4440	63	230	21680	
F 80 3_ 12.9		217	3560	87	670	18880	109	4480	55	350	23080	
F 80 3_ 14.0		200	3850	87	700	18830	100	4860	55	310	22970	
F 80 3_ 16.2		173	3760	73	760	20320	86	4740	46	430	24840	
F 80 3_ 17.6		159	4000	72	730	20260	80	5140	46	410	24730	
F 80 3_ 20.3		138	4060	63	780	21680	69	5120	40	440	26480	
F 80 3_ 22.0		127	4400	63	780	21600	64	5540	40	470	26380	
F 80 3_ 25.2		111	4230	53	700	23290	56	5330	33	360	28470	
F 80 3_ 28.8		97	6550	72	4590	20500	49	8000	44	5890	25350	
F 80 3_ 31.3		89	7100	72	4590	20000	45	8000	40	6040	26000	
F 80 3_ 36.0		78	7250	64	4560	21450	39	8000	35	6110	28090	
F 80 3_ 39.0		72	6700	54	4890	23010	36	8000	32	6240	28790	
F 80 3_ 45.3		62	7900	55	4440	22740	31	8000	28	6240	31120	
F 80 3_ 49.1		57	8000	52	4750	23150	28.5	8000	26	6360	31880	
F 80 3_ 56.7		49	8000	45	4780	25150	24.7	8000	22	6390	34260	
F 80 3_ 61.5		46	8000	41	4890	25790	22.8	8000	21	6500	35080	
F 80 3_ 70.4		40	8000	36	4850	27800	19.9	8000	18.0	6460	37470	
F 80 3_ 76.3		37	8000	33	4950	28490	18.3	8000	16.6	6560	38360	
F 80 3_ 85.2		33	8000	30	4940	30280	16.4	8000	14.8	6550	40480	
F 80 3_ 92.3		30	8000	27	5040	31030	15.2	8000	13.7	6640	41450	
F 80 3_ 105.0		26.7	8000	24	5000	33150	13.3	8000	12.0	6610	43970	
F 80 3_ 113.8		24.6	8000	22	5090	33950	12.3	8000	11.1	6700	45000	
F 80 3_ 122.5		22.9	8000	21	5020	35370	11.4	8000	10.3	6630	45000	
F 80 3_ 132.7		21.1	8000	19.1	5110	36230	10.6	8000	9.5	6720	45000	
F 80 3_ 147.9		18.9	8000	17.1	5060	38230	9.5	8000	8.6	6660	45000	
F 80 3_ 160.2		17.5	8000	15.8	5140	39140	8.7	8000	7.9	6750	45000	
F 80 3_ 184.6		15.2	8000	13.7	5090	41790	7.6	8000	6.9	6700	45000	
F 80 3_ 200.0		14.0	8000	12.7	5180	42790	7.0	8000	6.3	6780	45000	
F 80 4_ 218.5		12.8	8000	11.9	1020	45000	6.4	8000	5.9	2400	45000	
F 80 4_ 273.9		10.2	8000	9.5	1470	45000	5.1	8000	4.7	2680	45000	
F 80 4_ 296.7		9.4	8000	8.8	1470	45000	4.7	8000	4.4	2680	45000	
F 80 4_ 353.7		7.9	8000	7.3	1850	45000	4.0	8000	3.7	2770	45000	
F 80 4_ 383.2		7.3	8000	6.8	1850	45000	3.7	8000	3.4	2770	45000	
F 80 4_ 451.5		6.2	8000	5.8	2040	45000	3.1	8000	2.9	2820	45000	
F 80 4_ 489.1		5.7	8000	5.3	2040	45000	2.9	8000	2.7	2820	45000	
F 80 4_ 563.9		5.0	8000	4.6	2130	45000	2.5	8000	2.3	2860	45000	
F 80 4_ 610.9		4.6	8000	4.3	2130	45000	2.3	8000	2.1	2860	45000	
F 80 4_ 714.9		3.9	8000	3.6	2160	45000	2.0	8000	1.8	2890	45000	
F 80 4_ 774.4		3.6	8000	3.4	2160	45000	1.8	8000	1.7	2890	45000	
F 80 4_ 897.3		3.1	8000	2.9	2200	45000	1.6	8000	1.4	2930	45000	
F 80 4_ 972.0		2.9	8000	2.7	2200	45000	1.4	8000	1.3	2930	45000	
F 80 4_ 1058		2.6	8000	2.5	2210	45000	1.3	8000	1.2	2950	45000	
F 80 4_ 1146		2.4	8000	2.3	2210	45000	1.2	8000	1.1	2950	45000	
F 80 4_ 1277		2.2	8000	2.0	2230	45000	1.1	8000	1.0	2960	45000	
F 80 4_ 1384		2.0	8000	1.9	2230	45000	1.0	8000	0.94	2960	45000	
F 80 4_ 1578		1.8	8000	1.6	2240	45000	0.89	8000	0.82	2970	45000	
F 80 4_ 1709		1.6	8000	1.5	2240	45000	0.82	8000	0.76	2970	45000	
F 80 4_ 1834		1.5	8000	1.4	2250	45000	0.76	8000	0.71	2980	45000	
F 80 4_ 1987		1.4	8000	1.3	2250	45000	0.70	8000	0.65	2980	45000	



	i	n ₁ = 900 мин ⁻¹					n ₁ = 500 мин ⁻¹					
		n ₂ мин ⁻¹	M _{n2} Нм	P _{n1} кВт	R _{n1} Н	R _{n2} Н	n ₂ мин ⁻¹	M _{n2} Нм	P _{n1} кВт	R _{n1} Н	R _{n2} Н	
F 80 3_ 10.3	87	4740	47	—	24730	49	5770	32	—	29310	130	
F 80 3_ 11.2	80	5140	47	—	24630	45	6250	32	—	29180		
F 80 3_ 12.9	70	5200	41	—	26210	39	6320	28	—	31060		
F 80 3_ 14.0	64	5620	41	—	26100	36	6800	27	—	30970		
F 80 3_ 16.2	56	5490	34	—	28220	31	6250	22	1540	34170		
F 80 3_ 17.6	51	5960	34	—	28080	28.4	6800	22	1410	30030		
F 80 3_ 20.3	44	5930	30	—	30090	24.6	6250	17.4	3710	37270		
F 80 3_ 22.0	41	6420	30	—	29960	22.7	6800	17.5	3590	37220		
F 80 3_ 25.2	36	6175	25	—	32360	19.8	6250	14.0	4660	40450		
F 80 3_ 28.8	31	8000	28	7000	30980	17.4	8000	15.7	7000	39620		
F 80 3_ 31.3	28.8	8000	26	7000	31740	16.0	8000	14.4	7000	40560		
F 80 3_ 36.0	25.0	8000	23	7000	34070	13.9	8000	12.6	7000	43270		
F 80 3_ 39.0	23.1	8000	21	7000	34890	12.8	8000	11.6	7000	44300		
F 80 3_ 45.3	19.9	8000	18.0	7000	37490	11.0	8000	10.0	7000	45000		
F 80 3_ 49.1	18.3	8000	16.6	7000	38390	10.2	8000	9.2	7000	45000		
F 80 3_ 56.7	15.9	8000	14.3	7000	41050	8.8	8000	8.0	7000	45000		
F 80 3_ 61.5	14.6	8000	13.2	7000	42030	8.1	8000	7.3	7000	45000		
F 80 3_ 70.4	12.8	8000	11.6	7000	44690	7.1	8000	6.4	7000	45000		
F 80 3_ 76.3	11.8	8000	10.7	7000	45000	6.6	8000	5.9	7000	45000		
F 80 3_ 85.2	10.6	8000	9.5	7000	45000	5.9	8000	5.3	7000	45000		
F 80 3_ 92.3	9.8	8000	8.8	7000	45000	5.4	8000	4.9	7000	45000		
F 80 3_ 105.0	8.6	8000	7.7	7000	45000	4.8	8000	4.3	7000	45000		
F 80 3_ 113.8	7.9	8000	7.1	7000	45000	4.4	8000	4.0	7000	45000		
F 80 3_ 122.5	7.3	8000	6.6	7000	45000	4.1	8000	3.7	7000	45000		
F 80 3_ 132.7	6.8	8000	6.1	7000	45000	3.8	8000	3.4	7000	45000		
F 80 3_ 147.9	6.1	8000	5.5	7000	45000	3.4	8000	3.1	7000	45000		
F 80 3_ 160.2	5.6	8000	5.1	7000	45000	3.1	8000	2.8	7000	45000		
F 80 3_ 184.6	4.9	8000	4.4	7000	45000	2.7	8000	2.4	7000	45000		
F 80 3_ 200.0	4.5	8000	4.1	7000	45000	2.5	8000	2.3	7000	45000		
F 80 4_ 218.5	4.1	8000	3.8	3130	45000	2.3	8000	2.1	3500	45000		
F 80 4_ 273.9	3.3	8000	3.0	3240	45000	1.8	8000	1.7	3500	45000		
F 80 4_ 296.7	3.0	8000	2.8	3240	45000	1.7	8000	1.6	3500	45000		
F 80 4_ 353.7	2.5	8000	2.4	3330	45000	1.4	8000	1.3	3500	45000		
F 80 4_ 383.2	2.3	8000	2.2	3330	45000	1.3	8000	1.2	3500	45000		
F 80 4_ 451.5	2.0	8000	1.8	3380	45000	1.1	8000	1.0	3500	45000		
F 80 4_ 489.1	1.8	8000	1.7	3380	45000	1.0	8000	0.95	3500	45000		
F 80 4_ 563.9	1.6	8000	1.5	3420	45000	0.89	8000	0.82	3500	45000		
F 80 4_ 610.9	1.5	8000	1.4	3420	45000	0.82	8000	0.76	3500	45000		
F 80 4_ 714.9	1.3	8000	1.2	3460	45000	0.70	8000	0.65	3500	45000		
F 80 4_ 774.4	1.2	8000	1.1	3460	45000	0.65	8000	0.60	3500	45000		
F 80 4_ 897.3	1.0	8000	0.93	3490	45000	0.56	8000	0.52	3500	45000		
F 80 4_ 972.0	0.93	8000	0.86	3490	45000	0.51	8000	0.48	3500	45000		
F 80 4_ 1058	0.85	8000	0.79	3500	45000	0.47	8000	0.44	3500	45000		
F 80 4_ 1146	0.79	8000	0.73	3500	45000	0.44	8000	0.40	3500	45000		
F 80 4_ 1277	0.70	8000	0.65	3500	45000	0.39	8000	0.36	3500	45000		
F 80 4_ 1384	0.65	8000	0.60	3500	45000	0.36	8000	0.34	3500	45000		
F 80 4_ 1578	0.57	8000	0.53	3500	45000	0.32	8000	0.29	3500	45000		
F 80 4_ 1709	0.53	8000	0.49	3500	45000	0.29	8000	0.27	3500	45000		
F 80 4_ 1834	0.49	8000	0.46	3500	45000	0.27	8000	0.25	3500	45000		
F 80 4_ 1987	0.45	8000	0.42	3500	45000	0.25	8000	0.23	3500	45000		

(-) Для получения точных сведений необходимо обратиться в отдел технической поддержки и сообщить данные о радиальной нагрузке (направление вращения вала, угол и расположение точки приложения нагрузки)

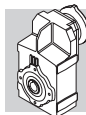

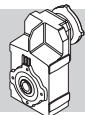

	i	n ₁ = 2800 мин ⁻¹					n ₁ = 1400 мин ⁻¹					
		n ₂ мин ⁻¹	M _{n2} Нм	P _{n1} кВт	R _{n1} Н	R _{n2} Н	n ₂ мин ⁻¹	M _{n2} Нм	P _{n1} кВт	R _{n1} Н	R _{n2} Н	
F 90 3_ 10.3		272	6500	200	5480	23780	136	8000	123	8000	29280	133
F 90 3_ 11.1		252	7150	204	5280	23290	126	8800	125	7770	28680	
F 90 3_ 13.4		209	7550	178	4880	24950	104	9300	110	7280	30710	
F 90 3_ 14.5		193	8100	177	5000	24650	97	10000	109	7400	30310	
F 90 3_ 16.5		170	8400	161	4540	25970	85	10300	99	6960	32040	
F 90 3_ 17.9		156	8950	158	4560	25700	78	11000	97	7180	31670	
F 90 3_ 20.6		136	9200	141	3980	27360	68	11300	87	6260	33720	
F 90 3_ 22.3		126	9750	138	4280	27120	63	12000	85	6590	33400	
F 90 3_ 25.4		110	10050	125	3620	28730	55	12000	75	6310	35980	
F 90 3_ 28.6		98	9750	108	9800	30870	49	12000	66	12390	38010	
F 90 3_ 31.0		90	10550	108	9800	30310	45	13000	66	12390	37290	
F 90 3_ 37.4		75	10950	93	9820	32820	37	13500	57	12420	40380	
F 90 3_ 40.5		69	11900	93	9820	32050	35	14000	55	12510	40550	
F 90 3_ 46.1		61	12050	83	9840	34290	30	14000	48	12560	43590	
F 90 3_ 49.9		56	13050	83	9840	33470	28.1	14000	44	12710	44670	
F 90 3_ 57.3		49	13050	72	9810	36320	24.4	14000	39	12680	48090	
F 90 3_ 62.1		45	14000	71	9830	35630	22.5	14000	36	12830	49260	
F 90 3_ 70.8		40	14000	63	9830	38520	19.8	14000	31	12830	52680	
F 90 3_ 76.7		37	14000	58	9960	39500	18.3	14000	29	12960	53950	
F 90 3_ 88.4		32	14000	50	9930	42780	15.8	14000	25	12930	55000	
F 90 3_ 95.8		29.2	14000	46	10050	43840	14.6	14000	23	13050	55000	
F 90 3_ 103.3		27.1	14000	43	9960	45920	13.6	14000	21	12960	55000	
F 90 3_ 111.9		25.0	14000	40	10080	47050	12.5	14000	19.8	13080	55000	
F 90 3_ 126.8		22.1	14000	35	10030	50250	11.0	14000	17.5	13030	55000	
F 90 3_ 137.3		20.4	14000	32	10140	51470	10.2	14000	16.1	13140	55000	
F 90 3_ 150.3		18.6	14000	29	10080	54040	9.3	14000	14.7	13080	55000	
F 90 3_ 162.8		17.2	14000	27	10220	55000	8.6	14000	13.6	13190	55000	
F 90 3_ 179.2		15.6	14000	25	10180	55000	7.8	14000	12.4	13100	55000	
F 90 3_ 194.2		14.4	14000	23	10220	55000	7.2	14000	11.4	13210	55000	
F 90 4_ 213.6		13.1	14000	21	—	55000	6.6	14000	10.6	—	55000	
F 90 4_ 231.4		12.1	14000	19.6	—	55000	6.1	14000	9.8	—	55000	
F 90 4_ 268.7		10.4	14000	16.9	—	55000	5.2	14000	8.5	420	55000	
F 90 4_ 291.1		9.6	14000	15.6	—	55000	4.8	14000	7.8	420	55000	
F 90 4_ 361.8		7.7	14000	12.6	—	55000	3.9	14000	6.3	990	55000	
F 90 4_ 392.0		7.1	14000	11.6	—	55000	3.6	14000	5.8	990	55000	
F 90 4_ 457.5		6.1	14000	9.9	—	55000	3.1	14000	5.0	1390	55000	
F 90 4_ 495.6		5.6	14000	9.2	—	55000	2.8	14000	4.6	1390	55000	
F 90 4_ 577.5		4.8	14000	7.9	—	55000	2.4	14000	3.9	1600	55000	
F 90 4_ 625.6		4.5	14000	7.3	—	55000	2.2	14000	3.6	1600	55000	
F 90 4_ 714.0		3.9	14000	6.4	—	55000	2.0	14000	3.2	1800	55000	
F 90 4_ 773.4		3.6	14000	5.9	—	55000	1.8	14000	2.9	1800	55000	
F 90 4_ 910.2		3.1	14000	5.0	—	55000	1.5	14000	2.5	2020	55000	
F 90 4_ 986.0		2.8	14000	4.6	—	55000	1.4	14000	2.3	2020	55000	
F 90 4_ 1112		2.5	14000	4.1	—	55000	1.3	14000	2.0	2110	55000	
F 90 4_ 1205		2.3	14000	3.8	—	55000	1.2	14000	1.9	2110	55000	
F 90 4_ 1318		2.1	14000	3.4	—	55000	1.1	14000	1.7	2220	55000	
F 90 4_ 1428		2.0	14000	3.2	—	55000	0.98	14000	1.6	2220	55000	
F 90 4_ 1571		1.8	14000	2.9	—	55000	0.89	14000	1.4	2260	55000	
F 90 4_ 1702		1.6	14000	2.7	—	55000	0.82	14000	1.3	2260	55000	
F 90 4_ 1937		1.4	14000	2.3	—	55000	0.72	14000	1.2	2300	55000	
F 90 4_ 2099		1.3	14000	2.2	—	55000	0.67	14000	1.1	2300	55000	

(-) Для получения точных сведений необходимо обратиться в отдел технической поддержки и сообщить данные о радиальной нагрузке (направление вращения вала, угол и расположение точки приложения нагрузки)



F 90

14000 Нм

	i	n ₁ = 900 мин ⁻¹					n ₁ = 500 мин ⁻¹					
		n ₂ мин ⁻¹	M _{n2} Нм	P _{n1} кВт	R _{n1} Н	R _{n2} Н	n ₂ мин ⁻¹	M _{n2} Нм	P _{n1} кВт	R _{n1} Н	R _{n2} Н	
F 90 3_ 10.3	87	9150	90	10010	33400	49	9600	53	15000	41900	133	
F 90 3_ 11.1	81	10050	92	9780	32740	45	10400	53	15000	41630		
F 90 3_ 13.4	67	10600	80	9270	35090	37	12500	53	12730	42090		
F 90 3_ 14.5	62	11400	80	9390	34630	34	13550	53	12720	41390		
F 90 3_ 16.5	55	11750	72	8890	36600	30	12300	42	14580	46420		
F 90 3_ 17.9	50	12550	71	9140	36180	27.9	13150	41	14820	46160		
F 90 3_ 20.6	44	12200	60	9100	39650	24.3	12200	33	15000	51030		
F 90 3_ 22.3	40	13200	60	9120	38970	22.4	13200	33	15000	50650		
F 90 3_ 25.4	35	12000	48	10430	43830	19.7	12000	27	15000	55000		
F 90 3_ 28.6	31	13700	49	14400	43400	17.5	14000	28	15000	55000		
F 90 3_ 31.0	29.0	14000	46	14540	43980	16.1	14000	26	15000	55000		
F 90 3_ 37.4	24.1	14000	38	14650	48390	13.4	14000	21	15000	55000		
F 90 3_ 40.5	22.2	14000	35	14820	49570	12.3	14000	19.5	15000	55000		
F 90 3_ 46.1	19.5	14000	31	14870	52960	10.8	14000	17.2	15000	55000		
F 90 3_ 49.9	18.0	14000	29	15000	54240	10.0	14000	15.8	15000	55000		
F 90 3_ 57.3	15.7	14000	25	14990	55000	8.7	14000	13.8	15000	55000		
F 90 3_ 62.1	14.5	14000	23	15000	55000	8.1	14000	12.7	15000	55000		
F 90 3_ 70.8	12.7	14000	20.1	15000	55000	7.1	14000	11.2	15000	55000		
F 90 3_ 76.7	11.7	14000	18.6	15000	55000	6.5	14000	10.3	15000	55000		
F 90 3_ 88.4	10.2	14000	16.1	15000	55000	5.7	14000	8.9	15000	55000		
F 90 3_ 95.8	9.4	14000	14.9	15000	55000	5.2	14000	8.3	15000	55000		
F 90 3_ 103.3	8.7	14000	13.8	15000	55000	4.8	14000	7.7	15000	55000		
F 90 3_ 111.9	8.0	14000	12.7	15000	55000	4.5	14000	7.1	15000	55000		
F 90 3_ 126.8	7.1	14000	11.2	15000	55000	3.9	14000	6.2	15000	55000		
F 90 3_ 137.3	6.6	14000	10.4	15000	55000	3.6	14000	5.8	15000	55000		
F 90 3_ 150.3	6.0	14000	9.5	15000	55000	3.3	14000	5.3	15000	55000		
F 90 3_ 162.8	5.5	14000	8.7	15000	55000	3.1	14000	4.9	15000	55000		
F 90 3_ 179.2	5.0	14000	7.9	15000	55000	2.8	14000	4.4	15000	55000		
F 90 3_ 194.2	4.6	14000	7.3	15000	55000	2.6	14000	4.1	15000	55000		
F 90 4_ 213.6	4.2	14000	6.8	810	55000	2.3	14000	3.8	2350	55000		
F 90 4_ 231.4	3.9	14000	6.3	810	55000	2.2	14000	3.5	2350	55000		
F 90 4_ 268.7	3.3	14000	5.4	1390	55000	1.9	14000	3.0	2920	55000		
F 90 4_ 291.1	3.1	14000	5.0	1390	55000	1.7	14000	2.8	2920	55000		
F 90 4_ 361.8	2.5	14000	4.0	1960	55000	1.4	14000	2.2	3390	55000		
F 90 4_ 392.0	2.3	14000	3.7	1960	55000	1.3	14000	2.1	3390	55000		
F 90 4_ 457.5	2.0	14000	3.2	2360	55000	1.1	14000	1.8	3490	55000		
F 90 4_ 495.6	1.8	14000	2.9	2360	55000	1.0	14000	1.6	3490	55000		
F 90 4_ 577.5	1.6	14000	2.5	2570	55000	0.87	14000	1.4	3500	55000		
F 90 4_ 625.6	1.4	14000	2.3	2570	55000	0.80	14000	1.3	3500	55000		
F 90 4_ 714.0	1.3	14000	2.0	2770	55000	0.70	14000	1.1	3500	55000		
F 90 4_ 773.4	1.2	14000	1.9	2770	55000	0.65	14000	1.0	3500	55000		
F 90 4_ 910.2	0.99	14000	1.6	2840	55000	0.55	14000	0.89	3500	55000		
F 90 4_ 986.0	0.91	14000	1.5	2840	55000	0.51	14000	0.82	3500	55000		
F 90 4_ 1112	0.81	14000	1.3	2860	55000	0.45	14000	0.73	3500	55000		
F 90 4_ 1205	0.75	14000	1.2	2860	55000	0.41	14000	0.67	3500	55000		
F 90 4_ 1318	0.68	14000	1.1	2890	55000	0.38	14000	0.62	3500	55000		
F 90 4_ 1428	0.63	14000	1.0	2890	55000	0.35	14000	0.57	3500	55000		
F 90 4_ 1571	0.57	14000	0.93	2900	55000	0.32	14000	0.52	3500	55000		
F 90 4_ 1702	0.53	14000	0.86	2900	55000	0.29	14000	0.48	3500	55000		
F 90 4_ 1937	0.46	14000	0.75	2910	55000	0.26	14000	0.42	3500	55000		
F 90 4_ 2099	0.43	14000	0.70	2910	55000	0.24	14000	0.39	3500	55000		

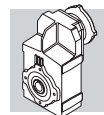

28 – ВОЗМОЖНЫЕ КОМБИНАЦИИ ЭЛЕКТРОДВИГАТЕЛЕЙ С РЕДУКТОРАМИ

В таблицах (B18) и (B19) ниже приведены физически возможные комбинации электродвигателей с редукторами.

Для правильного выбора комбинации электродвигателя и редуктора, исходя из их технических характеристик, необходимо следовать рекомендациям по процедуре выбора, данным в разделе 11 настоящего каталога («Выбор изделия»), обращая особое внимание на необходимость соблюдения условия $S \geq f_s$.

(B19)

		 IEC (IM B5)											
		P63	P71	P80	P90	P100	P112	P132	P160	P180	P200	P225	P250
F 10 2		7.4_127.1	7.4_127.1	7.4_91.5	7.4_91.5	7.4_91.5	7.4_91.5						
F 20 2		8.7_132.2 ⊖ (14.8_18.1)	8.7_132.2 ⊖ (14.8_18.1)	6.4_114.3	6.4_114.3	6.4_114.3	6.4_114.3						
F 20 3		156.3_545.3	156.3_545.3	156.3_545.3	156.3_545.3	156.3_545.3	156.3_545.3						
F 25 2		9.4_44.4 ⊖ (10.6_13.0)	9.4_44.4 ⊖ (10.6_13.0)	6.9_44.4	6.9_44.4	6.9_44.4	6.9_44.4						
F 25 3		50.8_333.1	50.8_333.1	45.6_288.1	45.6_288.1	45.6_288.1	45.6_288.1						
F 25 4		393.9_1374	393.9_1374	393.9_1374	393.9_1374	393.9_1374	393.9_1374						
F 31 2		18.5_44.6	18.5_44.6	6.9_44.6	6.9_44.6	6.9_44.6	6.9_44.6						
F 31 3		69.1_374.4	69.1_374.4	47.5_374.4	47.5_374.4	47.5_374.4	47.5_374.4						
F 31 4		418.9_1539	418.9_1539	418.9_1539	418.9_1539	418.9_1539	418.9_1539						
F 41 2		24.1_47.9	24.1_47.9	6.7_47.9	6.7_47.9	6.7_47.9	6.7_47.9	6.7_47.9					
F 41 3		84.9_344.8	84.9_344.8	51.5_344.8	51.5_344.8	51.5_344.8	51.5_344.8	51.5_168.7					
F 41 4	i =	433.7_1411	433.7_1411	433.7_1411	433.7_1411	433.7_1411	433.7_1411						
F 51 2		30.0_37.1	30.0_37.1	7.2_37.1	7.2_37.1	7.2_37.1	7.2_37.1	7.2_37.1					
F 51 3		105.1_352.5	105.1_352.5	48.9_352.5	48.9_352.5	48.9_352.5	48.9_352.5	48.9_202.4					
F 51 4		429.1_1439	429.1_1439	429.1_1439	429.1_1439	429.1_1439	429.1_1439						
F 60 3		98.2_280.7	98.2_280.7	11.8_280.7 ⊖ (29.6_32.1)	11.8_280.7 ⊖ (29.6_32.1)	11.8_280.7 ⊖ (29.6_32.1)	11.8_280.7 ⊖ (29.6_32.1)	9.0_201.4	9.0_201.4	9.0_201.4			
F 60 4		315.4_1141	315.4_1141	315.4_1141	315.4_1141	315.4_1141	315.4_1141						
F 70 3				85.4_196.0	85.4_196.0	85.4_196.0	85.4_196.0	16.3_196.0 ⊖ (27.7_38.4)	10.0_196.0	10.0_196.0	10.0_49.0 ⊖ (20.9_24.6)		
F 70 4		372.5_2188	372.5_2188	216.5_2188	216.5_2188	216.5_2188	216.5_2188	216.5_822.2					
F 80 3				105.0_200.0	105.0_200.0	105.0_200.0	105.0_200.0	20.3_200 ⊖ (28.8_49.1)	12.9_200 ⊖ (28.8_31.3)	10.3_200.0	10.3_132.7	10.3_132.7	
F 80 4		451.5_1987	451.5_1987	218.5_1987	218.5_1987	218.5_1987	218.5_1987	218.5_972					
F 90 3				126.8_194.2	126.8_194.2	126.8_194.2	126.8_194.2	25.4_194.2 ⊖ (28.6_62.1)	20.6_194.2 ⊖ (28.6_40.5)	10.3_194.2	10.3_162.8	10.3_162.8	10.3_162.8
F 90 4		577.5_2099	577.5_2099	213.6_2099	213.6_2099	213.6_2099	213.6_2099	213.6_1205	213.6_1205	213.6_1205			

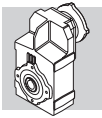

(B20)

								
		M05	M1	M2	M3	M4	M5	
F 10 2	i =	7.4_127.1	7.4_127.1	7.4_91.5	7.4_91.5			
F 20 2		8.7_132.2 ⊖(14.8_18.1)	8.7_132.2 ⊖(14.8_18.1)	6.4_114.3	6.4_114.3			
F 20 3		156.3_545.3	156.3_545.3	156.3_545.3	156.3_545.3			
F 25 2		9.4_44.4 ⊖(10.6_13.0)	9.4_44.4 ⊖(10.6_13.0)	6.9_44.4	6.9_44.4			
F 25 3		50.8_333.1	50.8_333.1	45.6_288.1	45.6_288.1			
F 25 4		393.9_1374	393.9_1374	393.9_1374	393.9_1374			
F 31 2			18.5_44.6	6.9_44.6	6.9_44.6			
F 31 3			69.1_374.4	47.5_374.4	47.5_374.4			
F 31 4		418.9_1539	418.9_1539	418.9_1539	418.9_1539			
F 41 2			24.1_47.9	6.7_47.9	6.7_47.9	6.7_47.9		
F 41 3			84.9_344.8	51.5_344.8	51.5_344.8	51.5_168.7		
F 41 4		433.7_1411	433.7_1411	433.7_1411	433.7_1411			
F 51 2			30.0_37.1	7.2_37.1	7.2_37.1	7.2_37.1		
F 51 3			105.1_352.5	48.9_352.5	48.9_352.5	48.9_202.4		
F 51 4			429.1_1439	429.1_1439	429.1_1439			
F 60 3				11.8_280.7 ⊖(29.6_32.1)	11.8_280.7 ⊖(29.6_32.1)	9_201.4	9_201.4	
F 60 4			315.4_1141	315.4_1141	315.4_1141	315.4_1141		
F 70 3				85.4_196	85.4_196	16.3_196.0 ⊖(27.7_38.4)	10.0_196.0	
F 70 4			372.5_2188	216.5_2188	216.5_2188	216.5_822.2		
F 80 3						20.3_200.0 ⊖(28.8_49.1)	12.9_200.0 ⊖(28.8_31.3)	
F 80 4		451.5_1987	218.5_1987	218.5_1987	218.5_972.0			
F 90 3					25.4_194.2 ⊖(28.6_62.1)	16.5_194.2 ⊖(28.6_40.5)		
F 90 4			213.6_2099	213.6_2099	213.6_1205			

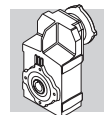

Адаптеры для двигателей соответствующие большинству распространенных типов сервомоторов доступны для типоразмеров редукторов F 10 ... F 60. Входные размеры сервомоторов представлены в чертежах для каждого типоразмера.

Код **SK** применяется для входного вала, обозначая шпоночный паз, в то время как обозначение **SC** означает входной вал с зажимным устройством.

(B21a)

		SERVO INPUT							
		SK60A	SK60B	SK80A	SK80B	SK80C	SK95A	SK95B	SK95C
		SC60A	SC60B	SC80A	SC80B	SC80C	SC95A	SC95B	SC95C
F 10 2	i =	7.4_127.1	7.4_71.1	7.4_71.1		7.4_91.5	7.4_71.1	7.4_91.5	7.4_91.5
F 20 2		8.7_132.2 ⌀(14.8_18.1)	8.7_90.4 ⌀(14.8_18.1)	8.7_90.4 ⌀(14.8_18.1)		6.4_114.3	8.7_90.4 ⌀(14.8_18.1)	6.4_114.3	6.4_114.3
F 20 3		156.3_545.3	156.3_545.3	156.3_545.3		156.3_545.3	156.3_545.3	156.3_545.3	156.3_545.3
F 25 2		9.4_44.4 ⌀(10.6_13.0)	9.4_44.4 ⌀(10.6_13.0)	9.4_44.4 ⌀(10.6_13.0)		6.9_44.4	9.4_44.4 ⌀(10.6_13.0)	6.9_44.4	6.9_44.4
F 25 3		45.6_333.1	45.6_227.8	45.6_227.8		45.6_288.1	45.6_227.8	45.6_288.1	45.6_288.1
F 25 4		393.9_1374	393.9_1374	393.9_1374		393.9_1374	393.9_1374	393.9_1374	393.9_1374
F 31 2		18.5_44.6	18.5_44.6	18.5_44.6		6.9_44.6	18.5_44.6	6.9_44.6	6.9_44.6
F 31 3		69.1_374.4	69.1_293.8	69.1_293.8		47.5_374.4	69.1_293.8	47.5_374.4	47.5_374.4
F 31 4		418.9_1539	418.9_1539	418.9_1539		418.9_1539	418.9_1539	418.9_1539	418.9_1539
F 41 2					24.1_47.9	6.7_47.9	24.1_47.9	6.7_47.9	6.7_47.9
F 41 3					84.9_344.8	51.5_344.8	84.9_344.8	51.5_344.8	51.5_344.8
F 41 4		433.7_1411	433.7_1411	433.7_1411		433.7_1411	433.7_1411	433.7_1411	433.7_1411
F 51 2					30.0_37.1	7.2_37.1	30.0_37.1	7.2_37.1	7.2_37.1
F 51 3					105.1_352.5	48.9_352.5	105.1_352.5	48.9_352.5	48.9_352.5
F 51 4		429.1_1439	429.1_1439	429.1_1439		429.1_1439	429.1_1439	429.1_1439	429.1_1439
F 60 3						11.8_280.7 ⌀(29.6_32.1)	106.4_280.7	11.8_280.7 ⌀(29.6_32.1)	11.8_280.7 ⌀(29.6_32.1)
F 60 4					315.4_1141	315.4_1141	315.4_1141	315.4_1141	315.4_1141

(B21b)

		SERVO INPUT					
		SK110A	SK110B	SK130A	SK130B	SK180A	SK180B
		SC110A	SC110B	SC130A	SC130B	SC180A	SC180B
F 10 2	i =	7.4_91.5	7.4_91.5				
F 20 2		6.4_114.3	6.4_114.3				
F 20 3		156.3_545.3	156.3_545.3				
F 25 2		6.9_44.4	6.9_44.4				
F 25 3		45.6_288.1	45.6_288.1				
F 25 4		393.9_1374	393.9_1374				
F 31 2		6.9_44.6	6.9_44.6	6.9_44.6			
F 31 3		47.5_374.4	47.5_374.4	47.5_374.4			
F 31 4		418.9_1539	418.9_1539				
F 41 2		6.7_47.9	6.7_47.9	6.7_47.9	6.7_47.9	6.7_47.9	6.7_47.9
F 41 3		51.5_344.8	51.5_344.8	51.5_344.8	51.5_168.7	51.5_168.7	51.5_168.7
F 41 4		433.7_1411	433.7_1411				
F 51 2		7.2_37.1	7.2_37.1	7.2_37.1	7.2_37.1	7.2_37.1	7.2_37.1
F 51 3		48.9_352.5	48.9_352.5	48.9_352.5	48.9_202.4	48.9_202.4	48.9_202.4
F 51 4		429.1_1439	429.1_1439	429.1_1439			
F 60 3		11.8_280.7 ⌀(29.6_32.1)	11.8_280.7 ⌀(29.6_32.1)	11.8_280.7 ⌀(29.6_32.1)	9.0_201.4	9.0_201.4	9.0_201.4
F 60 4		315.4_1141	315.4_1141	315.4_1141			

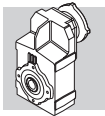

29 – МОМЕНТ ИНЕРЦИИ

В таблицах ниже приведены значения момента инерции J_r [кг м²] на входном валу редуктора.

Обозначения, используемые в таблице:



Значения для компактных редукторов (без учета инерции электродвигателя). Для получения значения момента инерции мотор-редуктора в целом следует к приведенному значению прибавить момент инерции соответствующего электродвигателя серии M, приведенный в таблице характеристик электродвигателей.



Значения для мотор-редукторов с электродвигателями IEC (без учета инерции электродвигателя).



Значения для редукторов с цельным входным валом.

F 10

	i	j (•10 ⁻⁴) [кгм ²]						
			63	71	80	90	100	
F 10 2_7.4	1.0	1.8	1.8	3.8	3.7	4.9	4.9	1.7
F 10 2_8.6	0.77	1.5	1.5	3.6	3.5	4.7	4.7	1.5
F 10 2_9.8	0.64	1.4	1.4	3.4	3.3	4.5	4.5	1.3
F 10 2_14.6	0.61	1.4	1.4	3.4	3.3	4.5	4.5	1.3
F 10 2_17.0	0.48	1.3	1.2	3.3	3.2	4.4	4.4	1.2
F 10 2_11.5	0.48	1.2	1.2	3.3	3.2	4.4	4.4	1.2
F 10 2_19.3	0.41	1.2	1.2	3.2	3.1	4.3	4.3	1.1
F 10 2_13.0	0.38	1.1	1.1	3.2	3.1	4.3	4.3	1.1
F 10 2_22.8	0.32	1.1	1.1	3.1	3.0	4.2	4.2	1.0
F 10 2_25.8	0.25	1.0	1.0	3.1	2.9	4.1	4.1	0.93
F 10 2_29.6	0.19	1.0	0.95	3.0	2.9	4.1	4.1	0.87
F 10 2_33.0	0.16	0.93	0.92	3.0	2.8	4.1	4.1	0.84
F 10 2_35.3	0.14	0.92	0.90	3.0	2.8	4.0	4.0	0.83
F 10 2_39.6	0.12	0.90	0.88	2.9	2.8	4.0	4.0	0.80
F 10 2_44.7	0.10	0.88	0.86	2.9	2.8	4.0	4.0	0.79
F 10 2_48.7	0.09	0.86	0.85	2.9	2.8	4.0	4.0	0.77
F 10 2_56.7	0.07	0.84	0.83	2.9	2.7	4.0	4.0	0.75
F 10 2_63.0	0.06	0.83	0.82	2.9	2.7	3.9	3.9	0.74
F 10 2_71.1	0.05	0.82	0.81	2.8	2.7	3.9	3.9	0.73
F 10 2_81.3	0.04	0.78	0.77	2.8	2.7	3.9	3.9	0.67
F 10 2_91.5	0.03	0.78	0.76	2.8	2.7	3.9	3.9	0.66
F 10 2_106.0	0.03	0.77	0.76	—	—	—	—	0.66
F 10 2_127.1	0.02	0.76	0.75	—	—	—	—	0.65

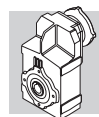





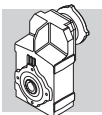

F 20

	i	j ($\cdot 10^{-4}$) [kV ²]						
			63	71	80	90	100	
F 20 2_6.4	2.2	—	—	5.0	4.8	6.0	6.0	3.9
F 20 2_7.8	1.5	—	—	4.3	4.2	5.4	5.4	3.3
F 20 2_8.7	1.3	2.0	2.0	4.1	3.9	5.2	5.2	3.0
F 20 2_10.0	1.0	1.8	1.7	3.8	3.7	4.9	4.9	2.7
F 20 2_11.2	0.88	1.6	1.6	3.6	3.5	4.7	4.7	2.6
F 20 2_14.8	1.2	—	—	4.0	3.9	5.1	5.1	2.9
F 20 2_18.1	0.90	—	—	3.7	3.5	4.7	4.7	2.6
F 20 2_20.2	0.78	1.5	1.5	3.5	3.4	4.6	4.6	2.5
F 20 2_23.1	0.64	1.4	1.3	3.4	3.3	4.5	4.5	2.4
F 20 2_25.9	0.57	1.3	1.3	3.3	3.2	4.4	4.4	2.3
F 20 2_30.4	0.41	1.1	1.1	3.2	3.0	4.3	4.3	2.1
F 20 2_33.1	0.36	1.1	1.1	3.1	3.0	4.2	4.2	2.1
F 20 2_37.9	0.30	1.0	1.0	3.1	2.9	4.1	4.1	2.0
F 20 2_41.8	0.27	1.0	1.0	3.0	2.9	4.1	4.1	2.0
F 20 2_44.8	0.24	1.0	1.0	3.0	2.9	4.1	4.1	2.0
F 20 2_50.7	0.21	0.93	0.92	3.0	2.8	4.1	4.1	1.9
F 20 2_56.7	0.18	0.91	0.90	2.9	2.8	4.0	4.0	1.9
F 20 2_61.9	0.16	0.89	0.88	2.9	2.8	4.0	4.0	1.9
F 20 2_69.1	0.14	0.87	0.86	2.9	2.8	4.0	4.0	1.8
F 20 2_76.8	0.12	0.86	0.85	2.9	2.8	4.0	4.0	1.8
F 20 2_90.4	0.10	0.84	0.82	2.9	2.7	3.9	3.9	1.8
F 20 2_101.6	0.09	0.80	0.79	2.8	2.7	3.9	3.9	1.8
F 20 2_114.3	0.08	0.79	0.77	2.8	2.7	3.9	3.9	1.8
F 20 2_132.2	0.03	0.78	0.77	—	—	—	—	1.8
F 20 3_156.3	0.04	0.81	0.80	2.8	2.7	3.9	3.9	0.72
F 20 3_172.6	0.04	0.81	0.80	2.8	2.7	3.9	3.9	0.72
F 20 3_184.9	0.04	0.81	0.80	2.8	2.7	3.9	3.9	0.72
F 20 3_209.3	0.03	0.81	0.79	2.8	2.7	3.9	3.9	0.72
F 20 3_234.0	0.03	0.81	0.79	2.8	2.7	3.9	3.9	0.71
F 20 3_255.3	0.03	0.80	0.79	2.8	2.7	3.9	3.9	0.71
F 20 3_285.2	0.03	0.80	0.79	2.8	2.7	3.9	3.9	0.71
F 20 3_316.9	0.03	0.80	0.79	2.8	2.7	3.9	3.9	0.71
F 20 3_372.9	0.03	0.80	0.79	2.8	2.7	3.9	3.9	0.71
F 20 3_419.3	0.03	0.80	0.79	2.8	2.7	3.9	3.9	0.66
F 20 3_471.7	0.03	0.80	0.79	2.8	2.7	3.9	3.9	0.66
F 20 3_545.3	0.03	0.80	0.79	2.8	2.7	3.9	3.9	0.66



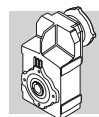

F 25

	i	j ($\cdot 10^{-4}$) [kgm ²]						
								
F 25 2_6.9	2.7	—	—	5.4	5.3	6.5	6.5	4.4
F 25 2_8.4	1.9	—	—	4.6	4.5	5.7	5.7	3.6
F 25 2_9.4	1.6	2.3	2.3	4.3	4.2	5.4	5.4	3.3
F 25 2_10.6	1.9	—	—	4.6	4.5	5.7	5.7	3.6
F 25 2_13.0	1.3	—	—	4.1	4.0	5.2	5.2	3.0
F 25 2_14.5	1.1	1.8	1.8	3.9	3.8	5.0	5.0	2.8
F 25 2_16.6	0.90	1.6	1.6	3.7	3.5	4.7	4.7	2.6
F 25 2_18.6	0.77	1.5	1.5	3.5	3.4	4.6	4.6	2.5
F 25 2_21.8	0.57	1.3	1.3	3.3	3.2	4.4	4.4	2.3
F 25 2_23.8	0.48	1.2	1.2	3.2	3.1	4.3	4.3	2.2
F 25 2_27.2	0.40	1.1	1.1	3.2	3.0	4.2	4.2	2.1
F 25 2_30.0	0.35	1.1	1.1	3.1	3.0	4.2	4.2	2.1
F 25 2_32.2	0.31	1.0	1.0	3.1	2.9	4.2	4.2	2.0
F 25 2_36.4	0.26	1.0	1.0	3.0	2.9	4.1	4.1	2.0
F 25 2_40.7	0.22	1.0	0.94	3.0	2.9	4.1	4.1	1.9
F 25 2_44.4	0.20	0.93	0.92	3.0	2.8	4.0	4.0	1.9
F 25 3_45.6	0.79	—	—	3.6	3.4	4.6	4.6	2.5
F 25 3_50.8	0.70	1.4	1.4	3.5	3.3	4.5	4.5	2.4
F 25 3_58.3	0.58	1.3	1.3	3.3	3.2	4.4	4.4	2.3
F 25 3_65.3	0.52	1.2	1.2	3.3	3.1	4.4	4.4	2.2
F 25 3_76.6	0.38	1.1	1.1	3.1	3.0	4.2	4.2	2.1
F 25 3_83.4	0.32	1.0	1.0	3.1	3.0	4.2	4.2	2.0
F 25 3_95.5	0.28	1.0	1.0	3.0	2.9	4.1	4.1	2.0
F 25 3_105.4	0.25	1.0	1.0	3.0	2.9	4.1	4.1	2.0
F 25 3_113.0	0.23	0.95	0.94	3.0	2.9	4.1	4.1	1.9
F 25 3_127.8	0.20	0.92	0.91	3.0	2.8	4.0	4.0	1.9
F 25 3_143.0	0.17	0.90	0.89	2.9	2.8	4.0	4.0	1.9
F 25 3_155.9	0.15	0.88	0.87	2.9	2.8	4.0	4.0	1.9
F 25 3_174.2	0.13	0.87	0.86	2.9	2.8	4.0	4.0	1.8
F 25 3_193.6	0.12	0.85	0.84	2.9	2.7	4.0	4.0	1.8
F 25 3_227.8	0.10	0.83	0.82	2.9	2.7	3.9	3.9	1.8
F 25 3_256.1	0.09	0.79	0.78	2.8	2.7	3.9	3.9	1.8
F 25 3_288.1	0.08	0.78	0.77	2.8	2.7	3.9	3.9	1.8
F 25 3_333.1	0.03	0.78	0.76	—	—	—	—	1.8
F 25 4_393.9	0.02	0.80	0.78	2.8	2.7	3.9	3.9	0.70
F 25 4_434.9	0.02	0.79	0.78	2.8	2.7	3.9	3.9	0.70
F 25 4_466.0	0.02	0.79	0.78	2.8	2.7	3.9	3.9	0.70
F 25 4_527.3	0.02	0.79	0.78	2.8	2.7	3.9	3.9	0.70
F 25 4_589.7	0.02	0.79	0.78	2.8	2.7	3.9	3.9	0.70
F 25 4_643.3	0.02	0.79	0.78	2.8	2.7	3.9	3.9	0.70
F 25 4_718.7	0.02	0.79	0.78	2.8	2.7	3.9	3.9	0.70
F 25 4_798.5	0.01	0.79	0.77	2.8	2.7	3.9	3.9	0.70
F 25 4_939.8	0.01	0.79	0.77	2.8	2.7	3.9	3.9	0.69
F 25 4_1057	0.01	0.79	0.77	2.8	2.7	3.9	3.9	0.64
F 25 4_1189	0.01	0.78	0.77	2.8	2.7	3.9	3.9	0.64
F 25 4_1374	0.01	0.78	0.77	2.8	2.7	3.9	3.9	0.64



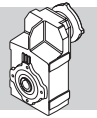

F 31

	i	j (•10 ⁻⁴) [krm ²]							
			63	71	80	90	100		112
F 31 2_6.9	5.0	—	—	—	7.8	7.6	8.9	8.9	7.1
F 31 2_8.2	3.7	—	—	—	6.5	6.3	7.5	7.5	5.8
F 31 2_9.0	3.2	—	—	—	6.0	5.8	7.0	7.0	5.3
F 31 2_10.7	3.5	—	—	—	6.3	6.2	7.4	7.4	5.6
F 31 2_12.7	2.6	—	—	—	5.4	5.3	6.5	6.5	4.7
F 31 2_13.9	2.3	—	—	—	5.1	4.9	6.2	6.2	4.4
F 31 2_16.8	1.8	—	—	—	4.6	4.4	5.6	5.6	3.9
F 31 2_18.5	1.5	2.2	2.2	—	4.2	4.1	5.3	5.3	3.5
F 31 2_21.1	1.1	1.8	1.8	—	3.9	3.7	5.0	5.0	3.2
F 31 2_23.4	1.0	1.7	1.7	—	3.7	3.6	4.8	4.8	3.0
F 31 2_27.3	0.78	1.5	1.5	—	3.5	3.4	4.6	4.6	2.8
F 31 2_30.1	0.65	1.4	1.4	—	3.4	3.3	4.5	4.5	2.7
F 31 2_34.4	0.53	1.3	1.2	—	3.3	3.2	4.4	4.4	2.6
F 31 2_37.7	0.47	1.2	1.2	—	3.2	3.1	4.3	4.3	2.5
F 31 2_40.4	0.42	1.1	1.1	—	3.2	3.0	4.3	4.3	2.5
F 31 2_44.6	0.37	1.1	1.1	—	3.1	3.0	4.2	4.2	2.4
F 31 3_47.5	1.6	—	—	—	4.3	4.2	5.4	5.4	3.6
F 31 3_52.1	1.4	—	—	—	4.2	4.0	5.3	5.3	3.5
F 31 3_62.8	1.2	—	—	—	3.9	3.8	5.0	5.0	3.2
F 31 3_69.1	1.0	1.7	1.7	—	3.7	3.6	4.8	4.8	3.0
F 31 3_78.9	0.72	1.4	1.4	—	3.5	3.4	4.6	4.6	2.8
F 31 3_87.4	0.66	1.4	1.4	—	3.4	3.3	4.5	4.5	2.7
F 31 3_101.9	0.54	1.3	1.2	—	3.3	3.2	4.4	4.4	2.6
F 31 3_112.5	0.46	1.2	1.2	—	3.2	3.1	4.3	4.3	2.5
F 31 3_128.4	0.38	1.1	1.1	—	3.1	3.0	4.2	4.2	2.4
F 31 3_140.7	0.35	1.1	1.1	—	3.1	3.0	4.2	4.2	2.4
F 31 3_150.8	0.31	1.0	1.0	—	3.1	2.9	4.2	4.2	2.4
F 31 3_166.8	0.28	1.0	1.0	—	3.0	2.9	4.1	4.1	2.3
F 31 3_185.4	0.24	1.0	1.0	—	3.0	2.9	4.1	4.1	2.3
F 31 3_202.3	0.21	0.94	0.93	—	3.0	2.8	4.1	4.1	2.3
F 31 3_228.2	0.18	0.92	0.90	—	2.9	2.8	4.0	4.0	2.2
F 31 3_253.6	0.16	0.89	0.88	—	2.9	2.8	4.0	4.0	2.2
F 31 3_293.8	0.13	0.86	0.85	—	2.9	2.8	4.0	4.0	2.2
F 31 3_332.8	0.11	0.82	0.81	—	2.9	2.7	4.0	4.0	2.2
F 31 3_374.4	0.10	0.81	0.79	—	2.9	2.7	3.9	3.9	2.2
F 31 4_418.9	0.09	0.86	0.85	—	2.9	2.8	3.9	3.9	0.77
F 31 4_462.6	0.08	0.86	0.84	—	2.9	2.7	3.9	3.9	0.77
F 31 4_527.8	0.08	0.85	0.84	—	2.9	2.7	3.9	3.9	0.76
F 31 4_578.6	0.08	0.85	0.84	—	2.9	2.7	3.9	3.9	0.76
F 31 4_619.9	0.07	0.85	0.83	—	2.9	2.7	3.9	3.9	0.76
F 31 4_685.6	0.07	0.85	0.83	—	2.9	2.7	3.9	3.9	0.76
F 31 4_762.3	0.07	0.84	0.83	—	2.9	2.7	3.9	3.9	0.75
F 31 4_831.6	0.07	0.84	0.83	—	2.9	2.7	3.9	3.9	0.75
F 31 4_938.2	0.07	0.84	0.83	—	2.9	2.7	3.9	3.9	0.75
F 31 4_1042	0.07	0.84	0.83	—	2.9	2.7	3.9	3.9	0.75
F 31 4_1208	0.06	0.84	0.82	—	2.9	2.7	3.9	3.9	0.75
F 31 4_1368	0.06	0.84	0.82	—	2.9	2.7	3.9	3.9	0.75
F 31 4_1539	0.06	0.84	0.82	—	2.9	2.7	3.9	3.9	0.75



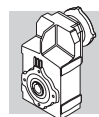

F 41

	i	j ($\cdot 10^{-4}$) [kgm ²]							
			63	71	80	90	100	112	
F 41 2_6.7	12	—	—	15	15	18	18	29	21
F 41 2_9.1	7.2	—	—	10	9.8	13	13	24	16
F 41 2_10.8	8.0	—	—	11	11	13	13	25	17
F 41 2_14.6	5.0	—	—	7.7	7.6	10	10	21	14
F 41 2_17.1	3.5	—	—	6.3	6.2	8.9	8.9	20	12
F 41 2_18.9	3.1	—	—	5.8	5.7	8.5	8.5	20	12
F 41 2_24.1	2.1	2.8	2.8	4.9	4.8	7.5	7.5	19	11
F 41 2_30.1	1.5	2.2	2.2	4.3	4.2	6.9	6.9	18	10
F 41 2_38.2	0.95	1.7	1.7	3.7	3.6	6.3	6.3	17	9.7
F 41 2_47.9	0.67	1.4	1.4	3.4	3.3	6.0	6.0	17	9.5
F 41 3_51.5	3.0	—	—	5.7	5.6	8.4	8.4	19	12
F 41 3_60.2	2.1	—	—	4.9	4.7	7.5	7.5	19	11
F 41 3_66.5	1.9	—	—	4.7	4.5	7.3	7.3	18	11
F 41 3_84.9	1.4	2.1	2.1	4.2	4.0	6.8	6.8	18	10
F 41 3_106.0	1.1	1.8	1.7	3.8	3.7	6.4	6.4	18	9.8
F 41 3_134.4	0.66	1.4	1.4	3.4	3.3	6.0	6.0	17	9.4
F 41 3_168.7	0.49	1.2	1.2	3.2	3.1	5.9	5.9	17	9.3
F 41 3_180.7	0.43	1.1	1.1	3.2	3.1	5.8	5.8	—	9.2
F 41 3_198.9	0.39	1.1	1.1	3.1	3.0	5.8	5.8	—	9.2
F 41 3_220.1	0.36	1.1	1.1	3.1	3.0	5.7	5.7	—	9.1
F 41 3_240.1	0.31	1.0	1.0	3.1	2.9	5.7	5.7	—	9.1
F 41 3_266.9	0.28	1.0	1.0	3.0	2.9	5.7	5.7	—	9.1
F 41 3_296.6	0.23	1.0	1.0	3.0	2.9	5.6	5.6	—	9.0
F 41 3_344.8	0.19	0.92	0.91	2.9	2.8	5.6	5.6	—	9.0
F 41 4_433.7	0.21	0.94	0.93	3.0	2.8	4.1	4.1	—	1.9
F 41 4_549.8	0.19	0.92	0.90	2.9	2.8	4.0	4.0	—	1.9
F 41 4_690.1	0.18	0.91	0.89	2.9	2.8	4.0	4.0	—	1.9
F 41 4_739.4	0.17	0.90	0.89	2.9	2.8	4.0	4.0	—	1.9
F 41 4_813.8	0.17	0.90	0.89	2.9	2.8	4.0	4.0	—	1.9
F 41 4_900.5	0.17	0.90	0.89	2.9	2.8	4.0	4.0	—	1.9
F 41 4_982.4	0.17	0.90	0.88	2.9	2.8	4.0	4.0	—	1.9
F 41 4_1092	0.16	0.89	0.88	2.9	2.8	4.0	4.0	—	1.9
F 41 4_1213	0.16	0.89	0.88	2.9	2.8	4.0	4.0	—	1.9
F 41 4_1411	0.16	0.89	0.88	2.9	2.8	4.0	4.0	—	1.9



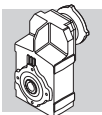

F 51

	i	j ($\cdot 10^{-4}$) [kNm ²]							
			63	71	80	90	100	112	
F 51 2_7.2	25	—	—	28	28	30	30	42	34
F 51 2_9.1	17	—	—	20	19	22	22	33	26
F 51 2_11.1	16	—	—	19	19	22	22	33	25
F 51 2_14.0	11	—	—	14	14	17	17	28	20
F 51 2_18.8	7.0	—	—	9.8	9.6	12	12	24	16
F 51 2_23.8	4.5	—	—	7.3	7.2	9.9	9.9	21	13
F 51 2_30.0	3.1	3.8	3.8	5.9	5.8	8.5	8.5	20	12
F 51 2_37.1	2.2	3.0	3.0	5.0	4.9	7.6	7.6	19	11
F 51 3_48.9	6.2	—	—	8.9	8.8	12	12	23	15
F 51 3_65.8	4.2	—	—	6.9	6.8	9.6	9.6	21	13
F 51 3_83.2	2.7	—	—	5.5	5.4	8.1	8.1	19	12
F 51 3_105.1	2.0	2.7	2.7	4.8	4.6	7.4	7.4	19	11
F 51 3_129.9	1.5	2.2	2.2	4.3	4.1	6.9	6.9	18	10
F 51 3_165.6	0.95	1.7	1.7	3.7	3.6	6.3	6.3	17	9.7
F 51 3_202.4	0.72	1.4	1.4	3.5	3.3	6.1	6.1	17	9.5
F 51 3_216.9	0.64	1.4	1.3	3.4	3.3	6.0	6.0	—	9.4
F 51 3_239.8	0.60	1.3	1.3	3.4	3.2	6.0	6.0	—	9.4
F 51 3_262.1	0.53	1.3	1.3	3.3	3.2	5.9	5.9	—	9.3
F 51 3_285.9	0.46	1.2	1.2	3.2	3.1	5.8	5.8	—	9.2
F 51 3_317.3	0.39	1.1	1.1	3.2	3.0	5.8	5.8	—	9.2
F 51 3_352.5	0.28	1.1	1.1	3.1	3.0	5.7	5.7	—	9.1
F 51 4_429.1	0.36	1.1	1.1	3.1	3.0	5.7	5.7	—	2.4
F 51 4_530.5	0.33	1.1	1.0	3.1	3.0	5.7	5.7	—	2.4
F 51 4_676.3	0.30	1.0	1.0	3.1	2.9	5.7	5.7	—	2.4
F 51 4_826.4	0.28	1.0	1.0	3.0	2.9	5.7	5.7	—	2.3
F 51 4_885.5	0.28	1.0	1.0	3.0	2.9	5.7	5.7	—	2.3
F 51 4_979.4	0.28	1.0	1.0	3.0	2.9	5.7	5.7	—	2.3
F 51 4_1070	0.27	1.0	1.0	3.0	2.9	5.6	5.6	—	2.3
F 51 4_1168	0.27	1.0	1.0	3.0	2.9	5.6	5.6	—	2.3
F 51 4_1296	0.26	1.0	1.0	3.0	2.9	5.6	5.6	—	2.3
F 51 4_1439	0.26	1.0	1.0	3.0	2.9	5.6	5.6	—	2.3



F 60

	i	j ($\cdot 10^{-4}$) [kgm ²]										
			63	71	80	90	100	112	132	160	180	
F 60 3_9.0	40	—	—	—	—	—	—	—	59	118	116	61
F 60 3_9.7	38	—	—	—	—	—	—	—	57	116	114	59
F 60 3_11.8	25	—	—	28	28	29	29	44	103	101	46	
F 60 3_12.7	24	—	—	27	27	28	28	43	102	100	45	
F 60 3_14.5	18	—	—	21	20	22	22	37	96	94	39	
F 60 3_15.7	17	—	—	20	20	21	21	36	95	93	38	
F 60 3_19.1	10	—	—	13	13	14	14	29	89	86	31	
F 60 3_20.7	9.9	—	—	13	13	14	14	29	88	86	31	
F 60 3_23.5	7.3	—	—	10	10	11	11	26	86	83	28	
F 60 3_25.4	7.1	—	—	9.9	9.9	11	11	26	85	83	28	
F 60 3_29.6	15	—	—	—	—	—	—	34	93	91	36	
F 60 3_32.1	15	—	—	—	—	—	—	34	93	91	36	
F 60 3_38.8	11	—	—	14	13	15	15	30	89	87	32	
F 60 3_42.1	11	—	—	13	13	15	15	29	89	87	31	
F 60 3_47.8	8.2	—	—	11	11	12	12	27	86	84	29	
F 60 3_51.8	8.1	—	—	11	11	12	12	27	86	84	29	
F 60 3_63.0	4.9	—	—	7.7	7.6	8.9	8.9	24	83	81	26	
F 60 3_68.3	4.8	—	—	7.7	7.6	8.9	8.9	24	83	81	26	
F 60 3_77.6	3.7	—	—	6.6	6.5	7.8	7.8	23	82	80	25	
F 60 3_84.0	3.7	—	—	6.5	6.5	7.8	7.8	23	82	80	25	
F 60 3_98.2	2.7	4.2	4.2	5.6	5.5	6.8	6.8	22	81	79	24	
F 60 3_106.4	2.7	4.2	4.2	5.5	5.4	6.8	6.8	22	81	79	24	
F 60 3_120.5	1.8	3.2	3.2	4.6	4.6	5.9	5.9	21	80	78	23	
F 60 3_130.5	1.8	3.2	3.2	4.6	4.6	5.8	5.8	21	80	78	23	
F 60 3_150.4	1.3	2.7	2.7	4.1	4.1	5.4	5.4	20	80	77	22	
F 60 3_162.9	1.3	2.7	2.7	4.1	4.1	5.4	5.4	20	80	77	22	
F 60 3_185.9	0.90	2.4	2.4	3.8	3.7	5.0	5.0	20	79	77	22	
F 60 3_201.4	0.90	2.4	2.4	3.8	3.7	5.0	5.0	20	79	77	22	
F 60 3_217.6	0.70	2.2	2.2	3.6	3.5	4.8	4.8	—	—	—	22	
F 60 3_235.8	0.70	2.2	2.2	3.6	3.5	4.8	4.8	—	—	—	22	
F 60 3_259.1	0.50	2.0	2.0	3.4	3.3	4.6	4.6	—	—	—	22	
F 60 3_280.7	0.50	2.0	2.0	3.4	3.3	4.6	4.6	—	—	—	22	

Для получения сведений о моменте инерции редукторов с 4 ступенями редукции необходимо обратиться в отдел технической поддержки компании.

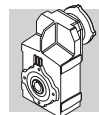

F 70

	i	j ($\cdot 10^{-4}$) [кГМ ²]									
		80	90	100	112	132	160	180	200		
F 70 3_10.0	—	—	—	—	—	—	169	167	176	133	
F 70 3_10.9	—	—	—	—	—	—	166	163	173	129	
F 70 3_12.8	—	—	—	—	—	—	139	137	146	102	
F 70 3_13.9	—	—	—	—	—	—	137	135	144	100	
F 70 3_16.3	39	—	—	—	—	58	117	115	124	80	
F 70 3_17.7	37	—	—	—	—	56	116	113	123	79	
F 70 3_20.9	26	—	—	—	—	45	105	102	—	68	
F 70 3_22.6	26	—	—	—	—	44	104	102	—	67	
F 70 3_24.6	21	—	—	—	—	40	99	97	—	62	
F 70 3_27.7	—	—	—	—	—	—	128	126	135	73	
F 70 3_30.0	—	—	—	—	—	—	127	125	134	73	
F 70 3_35.4	—	—	—	—	—	—	114	112	121	77	
F 70 3_38.4	—	—	—	—	—	—	114	111	121	77	
F 70 3_45.2	23	—	—	—	—	42	101	99	108	65	
F 70 3_49.0	23	—	—	—	—	42	101	99	108	65	
F 70 3_57.7	17	—	—	—	—	36	95	93	—	58	
F 70 3_62.5	17	—	—	—	—	36	95	93	—	58	
F 70 3_67.9	14	—	—	—	—	33	92	90	—	55	
F 70 3_73.6	14	—	—	—	—	33	92	90	—	55	
F 70 3_85.4	9.0	11	11	13	13	28	87	85	—	50	
F 70 3_92.5	9.0	11	11	13	13	28	87	85	—	50	
F 70 3_101.2	6.3	8.9	8.8	10	10	25	85	82	—	47	
F 70 3_109.6	6.3	8.9	8.8	10	10	25	85	82	—	47	
F 70 3_122.7	5.1	7.9	7.8	9.1	9.1	24	83	81	—	46	
F 70 3_133.0	5.1	7.9	7.8	9.1	9.1	24	83	81	—	46	
F 70 3_153.8	3.2	6.0	6.0	7.3	7.3	22	81	79	—	44	
F 70 3_166.7	3.2	6.0	6.0	7.3	7.3	22	81	79	—	44	
F 70 3_180.9	2.3	5.1	5.1	6.3	6.3	21	81	78	—	43	
F 70 3_196.0	2.3	5.1	5.0	6.3	6.3	21	81	78	—	43	

Для получения сведений о моменте инерции редукторов с 4 ступенями редукции необходимо обратиться в отдел технической поддержки компании.

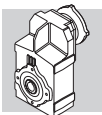

F 80

	i	j ($\cdot 10^{-4}$) [кГм ²]										
			80	90	100	112	132	160	180	200	225	
F 80 3_10.3	—	—	—	—	—	—	—	—	286	300	578	252
F 80 3_11.2	—	—	—	—	—	—	—	—	277	291	569	244
F 80 3_12.9	—	—	—	—	—	—	—	217	218	231	509	184
F 80 3_14.0	—	—	—	—	—	—	—	212	212	226	504	178
F 80 3_16.2	—	—	—	—	—	—	—	173	171	180	464	136
F 80 3_17.6	—	—	—	—	—	—	—	170	167	177	461	133
F 80 3_20.3	60	—	—	—	—	79	139	136	146	431	102	
F 80 3_22.0	58	—	—	—	—	77	136	134	143	429	100	
F 80 3_25.2	43	—	—	—	—	62	121	119	150	413	84	
F 80 3_28.8	—	—	—	—	—	—	—	189	203	480	155	
F 80 3_31.3	—	—	—	—	—	—	—	188	201	479	154	
F 80 3_36.0	—	—	—	—	—	—	155	155	169	447	121	
F 80 3_39.0	—	—	—	—	—	—	154	154	168	446	121	
F 80 3_45.3	—	—	—	—	—	—	133	132	141	425	97	
F 80 3_49.1	—	—	—	—	—	—	133	131	140	425	97	
F 80 3_56.7	35	—	—	—	—	54	113	111	120	406	77	
F 80 3_61.5	35	—	—	—	—	54	113	111	120	406	76	
F 80 3_70.4	27	—	—	—	—	46	105	103	133	397	68	
F 80 3_76.3	27	—	—	—	—	45	105	103	133	396	68	
F 80 3_85.2	20	—	—	—	—	39	99	96	126	389	62	
F 80 3_92.3	20	—	—	—	—	39	99	96	126	389	61	
F 80 3_105.0	14	16	16	17	17	32	92	90	119	383	55	
F 80 3_113.8	14	16	16	17	17	32	92	90	119	382	55	
F 80 3_122.5	13	15	15	17	17	32	91	89	118	381	54	
F 80 3_132.7	13	15	15	16	16	31	91	89	118	381	54	
F 80 3_147.9	8.5	11	11	13	13	27	87	85	114	377	50	
F 80 3_160.2	8.5	11	11	13	13	27	87	84	—	—	50	
F 80 3_184.6	5.1	7.9	7.8	9.1	9.1	24	83	81	—	—	46	
F 80 3_200.0	5.0	7.9	7.8	9.1	9.1	24	83	81	—	—	46	

Для получения сведений о моменте инерции редукторов с 4 ступенями редукции необходимо обратиться в отдел технической поддержки компании.

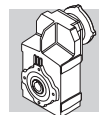

F 90

	i	j ($\cdot 10^{-4}$) [кГМ ²]											
		80	90	100	112	132	160	180	200	225	250		
F 90 3_10.3	—	—	—	—	—	—	—	—	—	—	843	870	510
F 90 3_11.1	—	—	—	—	—	—	—	—	—	—	823	850	489
F 90 3_13.4	—	—	—	—	—	—	—	—	—	—	667	694	333
F 90 3_14.5	—	—	—	—	—	—	—	—	—	—	655	682	321
F 90 3_16.5	—	—	—	—	—	—	—	—	—	—	580	607	246
F 90 3_17.9	—	—	—	—	—	—	—	—	—	—	572	599	238
F 90 3_20.6	—	—	—	—	—	—	—	224	222	232	516	542	184
F 90 3_22.3	—	—	—	—	—	—	—	220	217	227	511	537	179
F 90 3_25.4	103	—	—	—	—	—	122	181	179	188	474	500	142
F 90 3_28.6	—	—	—	—	—	—	—	—	—	—	585	613	252
F 90 3_31.0	—	—	—	—	—	—	—	—	—	—	583	610	250
F 90 3_37.4	—	—	—	—	—	—	—	—	—	—	516	543	182
F 90 3_40.5	—	—	—	—	—	—	—	—	—	—	514	541	181
F 90 3_46.1	—	—	—	—	—	—	—	—	—	—	480	507	147
F 90 3_49.9	—	—	—	—	—	—	—	—	—	—	479	506	146
F 90 3_57.3	73	—	—	—	—	—	—	161	158	168	452	479	120
F 90 3_62.1	72	—	—	—	—	—	—	160	158	167	451	478	120
F 90 3_70.8	61	—	—	—	—	—	80	139	137	146	432	458	100
F 90 3_76.7	60	—	—	—	—	—	79	139	136	146	431	458	100
F 90 3_88.4	44	—	—	—	—	—	63	123	120	151	414	441	83
F 90 3_95.8	44	—	—	—	—	—	63	122	120	151	414	441	83
F 90 3_103.3	41	—	—	—	—	—	59	119	117	146	410	436	78
F 90 3_111.9	40	—	—	—	—	—	59	119	116	146	409	436	78
F 90 3_126.8	26	29	29	30	30	45	105	102	132	395	422	64	
F 90 3_137.3	26	29	29	30	30	45	104	102	132	395	422	64	
F 90 3_150.3	21	24	24	25	25	40	100	97	127	390	417	59	
F 90 3_162.8	21	24	24	25	25	40	100	97	127	390	417	59	
F 90 3_179.2	14	16	16	18	18	33	92	90	—	—	—	51	
F 90 3_194.2	14	16	16	17	17	33	92	90	—	—	—	51	

Для получения сведений о моменте инерции редукторов с 4 ступенями редукции необходимо обратиться в отдел технической поддержки компании.

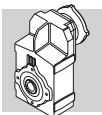

31.0 – ТОЧНЫЕ ЗНАЧЕНИЯ ПЕРЕДАТОЧНЫХ ЧИСЕЛ

i_N	F 10	F 20	F 25	F 31	F 41	F 51	F 60	F 70	F 80	F 90
6.3		6.41210								
7.1	7.40443		6.86957	6.94907	6.72727	7.19408				
8.0		7.83478	8.39375	8.22917						
9.0	8.58204	8.73227	9.35526	9.01630	9.13580	9.05114	8.96000			
10.0	9.76974	10.03069	10.62451	10.74747			9.70667	10.01538	10.33846	10.26577
11.2	11.53759	11.23370			10.77273	11.11005	11.75320	10.85000	11.20000	11.12125
12.5	13.02632		12.98182	12.72727		13.97796	12.73263	12.81731	12.90240	13.41346
14.0	14.64777	14.79842	14.46890	13.94466	14.62963		14.47385	13.88542	13.97760	14.53125
16.0	16.97738		16.62032	16.80000	17.11667		15.68000	16.34455	16.24615	16.52538
18.0		18.08182	18.61364	18.48804	18.89130	18.82155	19.06872	17.70660	17.60000	17.90250
20.0	19.32692	20.15311	21.81818	21.11230			20.65778	20.86538	20.33231	20.56731
22.4	22.82418	23.14973	23.75758	23.38636		23.79447	23.46381	22.60417	22.02667	22.28125
25.0	25.76923	25.92614	27.20455	27.27273	24.11579		25.41913	24.55695	25.22585	25.38622
28.0	29.63462	30.38961	30.03636	30.12121	30.11875	30.03828	29.61538	27.69231	28.84615	28.61169
31.5	32.98462	33.09091	32.18182	34.36364			32.08333	30.00000	31.25000	30.99600
35.5	35.34066	37.89205	36.41958	37.67273	38.18333	37.13636	38.84771	35.43956	36.00000	37.38462
40.0	39.64497	41.83636	40.72727	40.36364			42.08502	38.39286	39.00000	40.50000
45.0	44.66667	44.82468	45.56607	44.64336	47.92667		47.84024	45.19231	45.32967	46.05785
50.0	48.72727	50.72727	50.78571	47.54630	51.49270	48.89965	51.82692	48.95833	49.10714	49.89600
56.0	56.69231	56.72727	58.33718	52.09420	60.24646		63.02761	57.69231	56.73077	57.32308
63.0	62.99145	61.88430	65.33371	62.76111	66.49275	65.84416	68.27991	62.50000	61.45833	62.10000
71.0	71.12308	69.13636	76.58163	69.06725			77.55467	73.55769	70.38462	70.75385
80.0	81.31624	76.81818	83.38889	78.87092	84.88166	83.24111	84.01756	85.38462	76.25000	76.65000
90.0	91.48077	90.40909	95.48772	87.36632			98.19838	92.50000	92.30769	88.39385
100.0	106.02198	101.63636	105.42738	101.88492	106.01061	105.08407	106.38158	101.18343	105.00000	103.33491
112.2		114.34091	112.95791	112.52623			120.45488	109.61538	113.75000	111.94615
125.5	127.12821	132.19481	127.83242	128.37500	134.39596	129.91558	130.49279	122.72727	122.48521	126.77538
140.0		156.30469	142.95238	140.73704			150.35503	132.95455	132.69231	150.30533
160.0		172.57500	155.94805	166.77778	168.69010	165.62338	162.88462	166.66667	160.22727	162.83077
180.0		184.90179	174.22321	185.43056	180.73939	202.39481	185.89349	180.94406	184.61538	179.21958
200.0		209.25000	193.58135	202.28788	198.92028	216.85158	201.38462	196.02273	200.00000	194.15455
225.0		234.00000	227.83036	228.22222	220.13131	239.84416	217.64679	216.52422	218.49174	213.59178
250.0		255.27273	256.12302	253.58025	240.14325	262.11039	259.08284	234.56790	273.89277	231.39109
280.0		285.18750	288.13839	293.83611	266.93818	285.93861	280.67308	280.93645	296.71717	268.72770
315.0		316.87500	333.13010	332.82407	296.59798	317.26753	315.38899	304.34783	353.67893	291.12168
355.0		372.93750		374.42708	344.79515	352.51948	341.67140	372.46964	383.15217	361.84615
400.0		419.25000	393.88686	418.86023		429.09330	399.34008	403.50877	451.49061	392.00000
450.0		471.65625	434.88795	462.60785	433.67975		432.61842	471.15385	489.11483	457.45099
500.0			465.95137	527.76389			489.84985	510.41667	563.87675	495.57191
560.0		545.30357	527.30872	578.58560	549.80165	530.48864	530.67067	606.83761	610.86648	577.48888
630.0			589.67857	619.91314	690.09587	676.29545	611.44379	657.40741	714.86014	625.61296
710.0			643.28571	685.64198	739.38843	826.44545	755.96686	758.97436	774.43182	713.95030
800.0			718.67076	762.32562	813.76478	885.47727	818.96410	822.22222	897.27273	773.44615
900.0			798.52307	831.62795	900.53719	979.36364	885.09695	899.40828	972.04545	910.18225
1000.0			939.80022	938.24691	982.40421	1070.28409	958.85503	974.35897	1058.06885	986.03077
1125.0			1056.50744	1042.49657	1092.01983	1167.58264	1053.60355	1090.90909	1146.24126	1112.25941
1250.0			1188.57087	1207.99290	1213.35537	1295.50909	1141.40385	1181.81818	1277.33630	1204.94769
1400.0			1374.16167	1368.27675	1410.52562	1439.45455		1367.52137	1383.78099	1427.90059
1600.0				1539.31134				1584.61538	1577.62238	1571.37386
1800.0								1716.66667	1709.09091	1702.32168
2000.0								2019.23077	1833.98601	1937.26864
2250.0								2187.50000	1986.81818	2098.70769



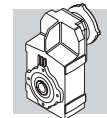

32 - РАЗМЕРЫ

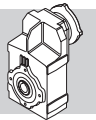

F 10...M

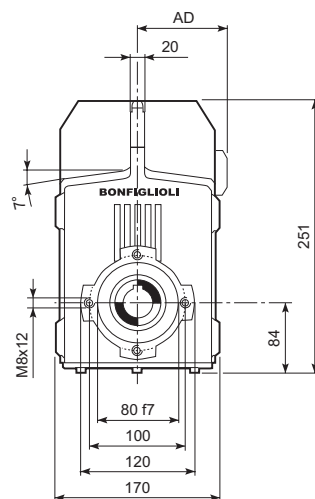
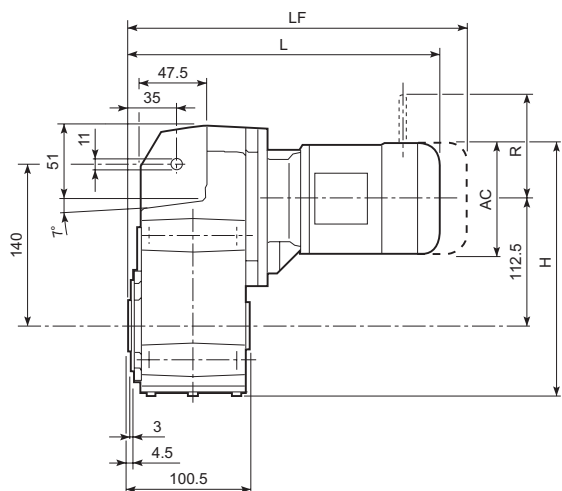

G	D	E	AC	H	L	AD		M_FD M_FA		M_FD		M_FA	
								LF		R	AD	R	AD
F 10 2	S05	M05	121	220.5	311.5	95	12	377.5	13	96	119	116	95
F 10 2	S1	M1S	138	265.5	316.5	108	12	379.5	15	103	132	124	108
F 10 2	S1	M1L	138	265.5	340.5	108	14	401.5	17	103	132	124	108
F 10 2	S2	M2S	156	274.5	369.5	119	18	439.5	21	129	143	134	119
F 10 2	S3	M3S	195	294	412.5	142	22	508.5	30	160	155	160	142
F 10 2	S3	M3L	195	294	444.5	142	24	535.5	31	160	155	160	142

F 10...P(IEC)

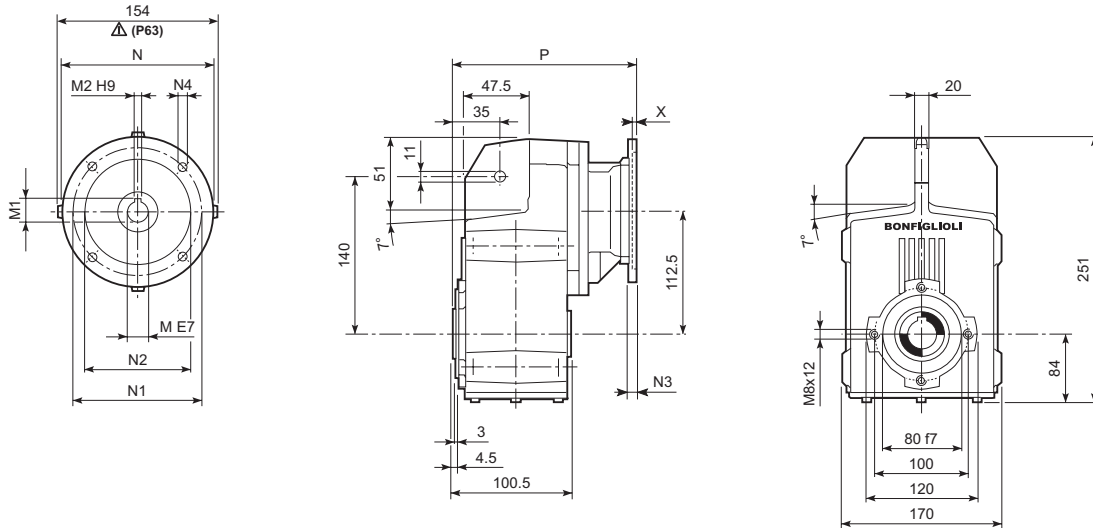
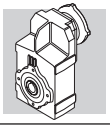

		M	M1	M2	N	N1	N2	N3	N4	X	P	
		11	12.8	4	140	115	95	—	M8x19	4	185.5	8
		14	16.3	5	160	130	110	—	M8x16	4.5	185.5	8
		19	21.8	6	200	165	130	—	M10x12	4	205	9
		24	27.3	8	200	165	130	—	M10x12	4	205	9
		28	31.3	8	250	215	180	—	M12x16	4.5	215	13
		28	31.3	8	250	215	180	—	M12x16	4.5	215	13

F 10...HS

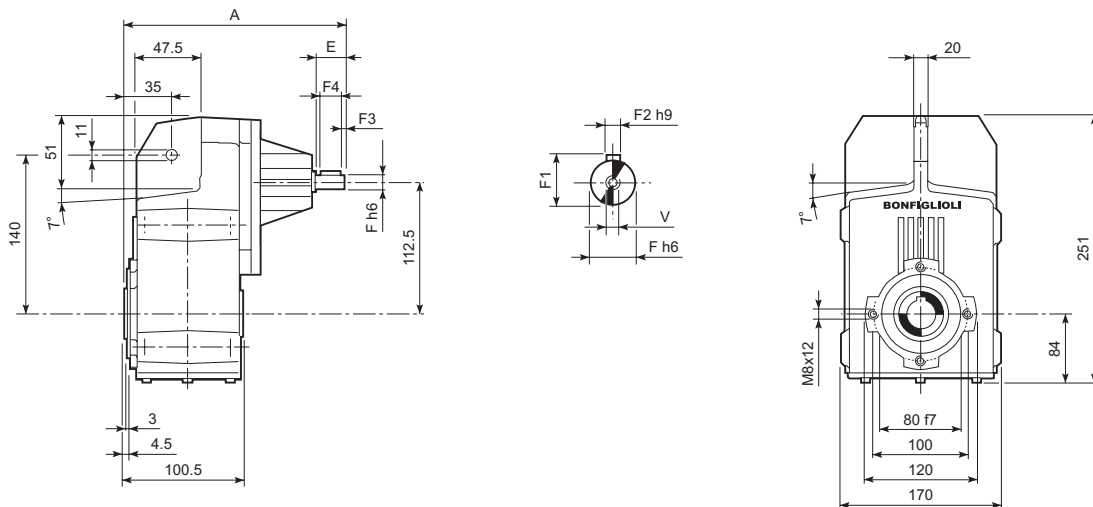

		A	E	F	F1	F2	F3	F4	V	
		192	40	16	18	5	2.5	35	M6x16	7.5

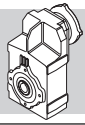

F 10...SK / SC

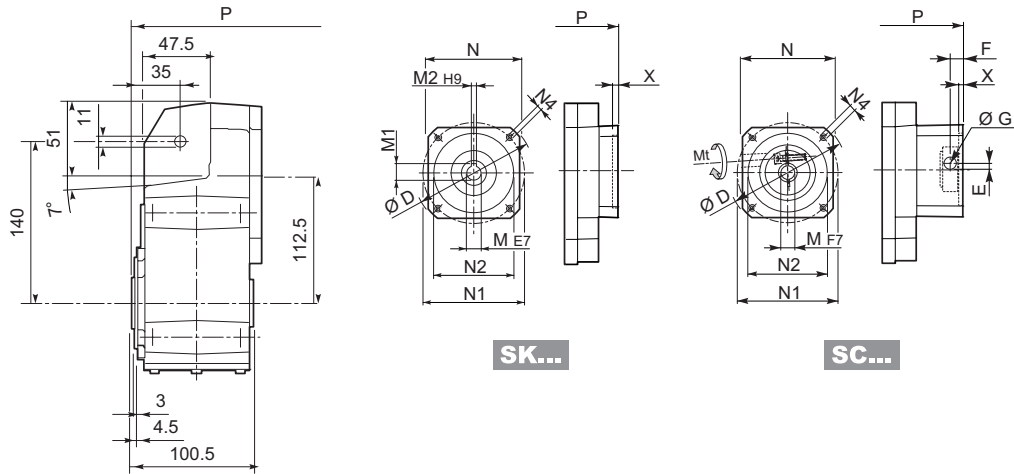

		D	M	M1	M2	N	N1	N2	N4	X	P	
F 10 2	SK 60A	102	11	12.8	4	82	75	60	M5x10	3.5	157	8
F 10 2	SK 60B	102	14	16.3	5	82	75	60	M5x10	4	164	8
F 10 2	SK 80A	115	14	16.3	5	90	100	80	M6x12	4	164	8
F 10 2	SK 80C	120	19	21.8	6	96	100	80	M6x12	4	205	9
F 10 2	SK 95A	130	14	16.3	5	102	115	95	M8x12	4	205	9
F 10 2	SK 95B	130	19	21.8	6	102	115	95	M8x12	4	205	9
F 10 2	SK 95C	130	24	27.3	8	102	115	95	M8x12	4	205	9
F 10 2	SK 110A	150	19	21.8	6	120	130	110	M8x12	5	205	9
F 10 2	SK 110B	150	24	27.3	8	120	130	110	M8x12	5	205	9

		Mt		D	E	F	G	M	N	N1	N2	N4	X	P	
F 10 2	SC 60A	M6	15 Nm	102	7	12.5	12.5	11	82	75	60	M5x10	4	184	8
F 10 2	SC 60B	M6	15 Nm	102	7	12.5	12.5	14	82	75	60	M5x10	4	184	9
F 10 2	SC 80A	M6	15 Nm	115	6	12.5	12.5	14	90	100	80	M6x12	4	184	9
F 10 2	SC 80C	M6	15 Nm	120	15.5	14.5	17.75	19	96	100	80	M6x12	4	228.5	10
F 10 2	SC 95A	M6	15 Nm	130	16.5	15	17.75	14	102	115	95	M8x16	4	228.5	10
F 10 2	SC 95B	M6	15 Nm	130	16.5	15	17.75	19	102	115	95	M8x16	4	228.5	10
F 10 2	SC 95C	M6	15 Nm	130	16.5	15	17.75	24	102	115	95	M8x16	4	228.5	10
F 10 2	SC 110A	M6	15 Nm	150	16.5	16	17.75	19	120	130	110	M8x16	5	228.5	11
F 10 2	SC 110B	M6	15 Nm	150	16.5	16	17.75	24	120	130	110	M8x16	5	228.5	11

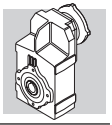

F 10...H

H25 STANDARD

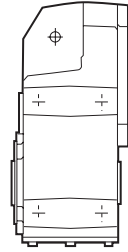
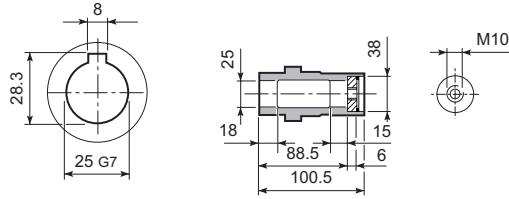

F 10...S

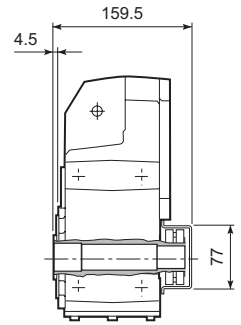
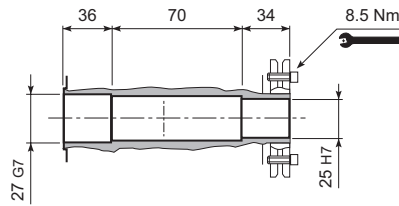

F 10...R

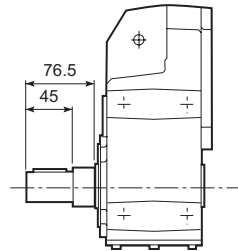
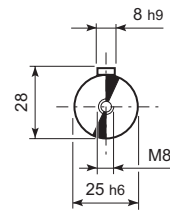

F 10...QF

	Ø
QF25	25
QF30	30

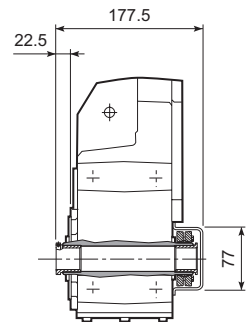
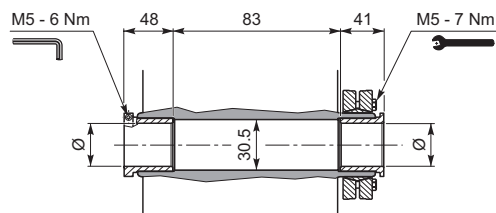

F 10...F...

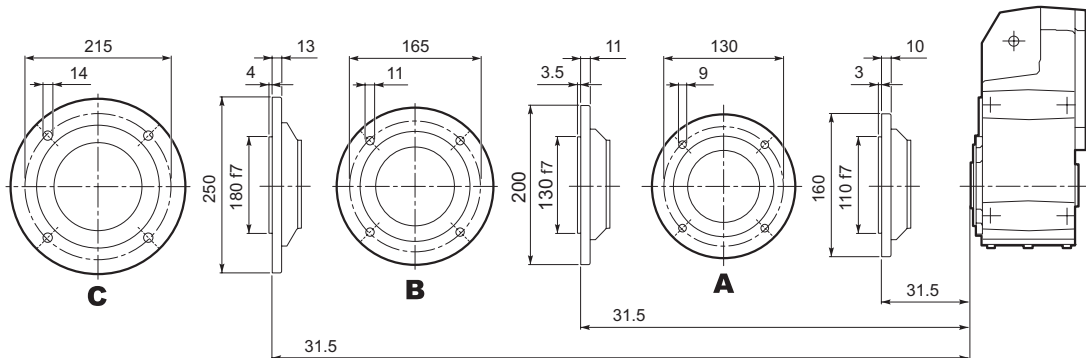

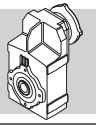

F 20...M

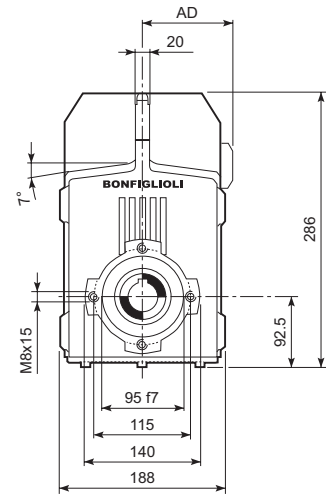
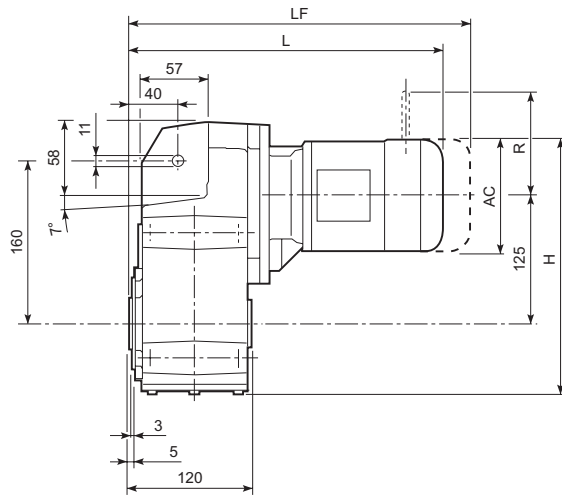

								M_FD M_FA		M_FD		M_FA	
			AC	H	L	AD		LF		R	AD	R	AD
F 20 2	S05	M05	121	278.2	323.5	95	15	389.5	17	96	119	116	95
F 20 2	S1	M1S	138	286.7	328.5	108	16	391.5	19	103	132	124	108
F 20 2	S1	M1L	138	286.7	352.5	108	17	413.5	20	103	132	124	108
F 20 2	S2	M2S	156	295.7	381.5	119	21	451.5	25	129	143	134	119
F 20 2	S3	M3S	195	315.2	424.5	142	26	520.5	33	160	155	160	142
F 20 2	S3	M3L	195	315.2	456.5	142	31	547.5	38	160	155	160	142
F 20 3	S05	M05	121	278.2	379	95	17	445	18	96	119	116	95
F 20 3	S1	M1S	138	286.7	384	108	18	447	20	103	132	124	108
F 20 3	S1	M1L	138	286.7	408	108	19	469	21	103	132	124	108
F 20 3	S2	M2S	156	295.7	437	119	22	507	26	129	143	134	119
F 20 3	S3	M3S	195	315.2	480	142	27	576	34	160	155	160	142
F 20 3	S3	M3L	195	315.2	512	142	32	603	39	160	155	160	142

F 20...P(IEC)

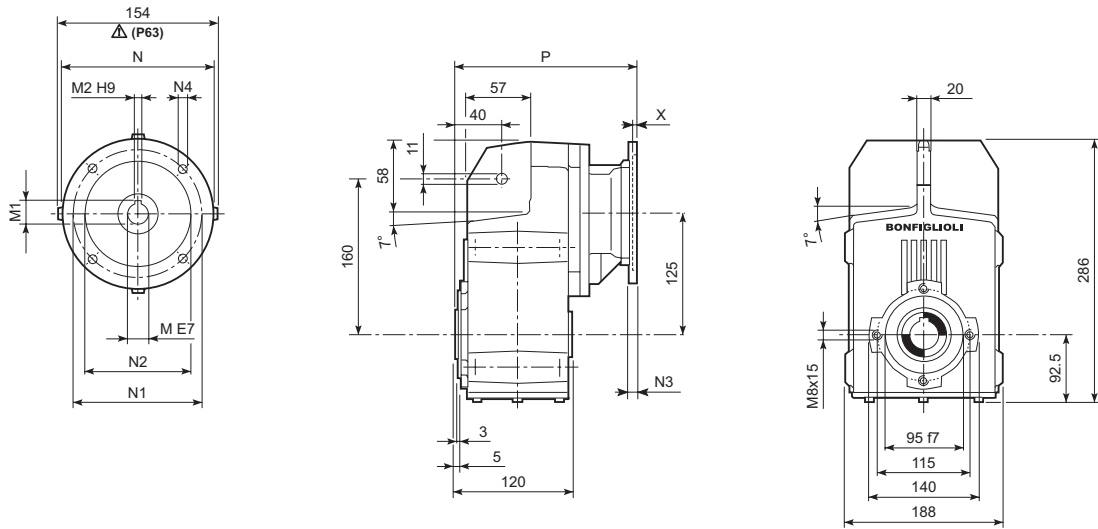
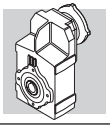

		M	M1	M2	N	N1	N2	N3	N4	X	P	
F 20 2	P63	11	12.8	4	140	115	95	—	M8x19	4	197.5	12
F 20 2	P71	14	16.3	5	160	130	110	—	M8x16	4.5	197.5	12
F 20 2	P80	19	21.8	6	200	165	130	—	M10x12	4	217	13
F 20 2	P90	24	27.3	8	200	165	130	—	M10x12	4	217	12
F 20 2	P100	28	31.3	8	250	215	180	—	M12x16	4.5	227	16
F 20 2	P112	28	31.3	8	250	215	180	—	M12x16	4.5	227	16
F 20 3	P63	11	12.8	4	140	115	95	—	M8x19	4	253	13
F 20 3	P71	14	16.3	5	160	130	110	—	M8x16	4.5	253	13
F 20 3	P80	19	21.8	6	200	165	130	—	M10x12	4	272.5	14
F 20 3	P90	24	27.3	8	200	165	130	—	M10x12	4	272.5	14
F 20 3	P100	28	31.3	8	250	215	180	—	M12x16	4.5	282.5	18
F 20 3	P112	28	31.3	8	250	215	180	—	M12x16	4.5	282.5	18

F 20...HS

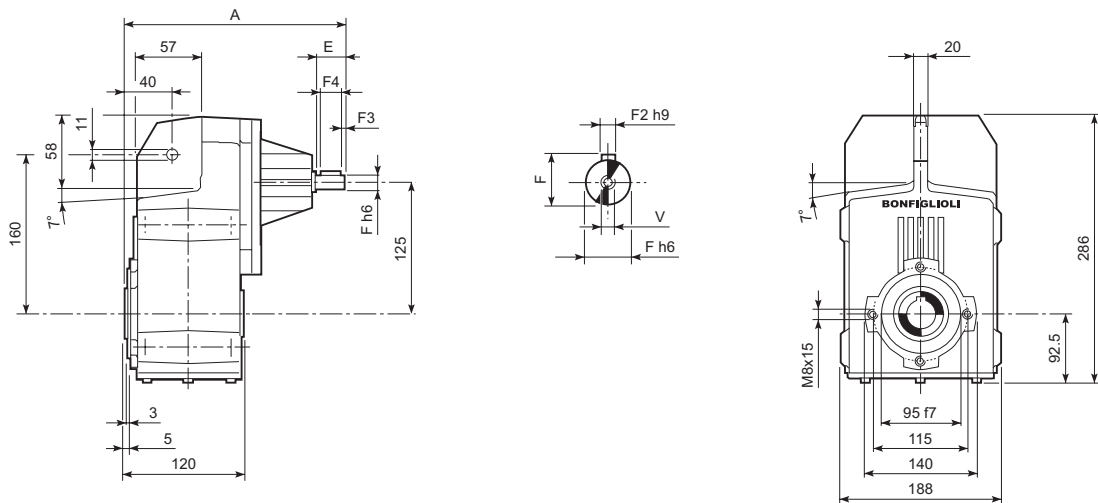

		A	E	F	F1	F2	F3	F4	V	
F 20 2	HS	247.5	40	19	21.5	6	2.5	35	M6x16	11.5
F 20 3		260	40	16	18	5	2.5	35	M6x16	12.4

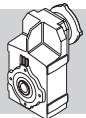

F 20...SK / SC

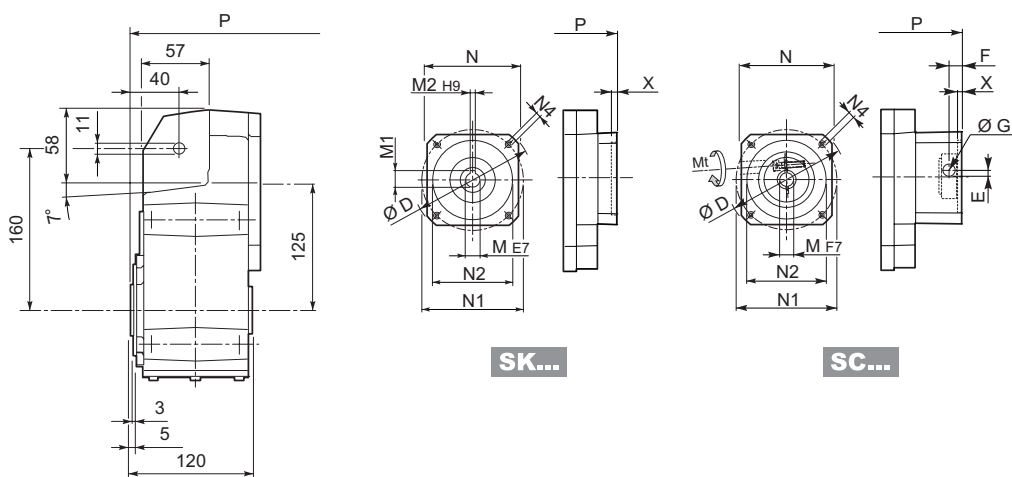

SK...

SC...

C	D	M	M1	M2	N	N1	N2	N4	X	2x		3x		
										P		P		
F 20 2/3	SK 60A	102	11	12.8	4	82	75	60	M5x10	3.5	169	11	224.5	12
F 20 2/3	SK 60B	102	14	16.3	5	82	75	60	M5x10	4	176	12	231.5	13
F 20 2/3	SK 80A	115	14	16.3	5	90	100	80	M6x12	4	217	12	231.5	13
F 20 2/3	SK 80C	120	19	21.8	6	96	100	80	M6x12	4	217	13	272.5	14
F 20 2/3	SK 95A	130	14	16.3	5	102	115	95	M8x12	4	217	13	272.5	14
F 20 2/3	SK 95B	130	19	21.8	6	102	115	95	M8x12	4	217	13	272.5	14
F 20 2/3	SK 95C	130	24	27.3	8	102	115	95	M8x12	4	217	13	272.5	14
F 20 2/3	SK 110A	150	19	21.8	6	120	130	110	M8x12	5	217	13	272.5	14
F 20 2/3	SK 110B	150	24	27.3	8	120	130	110	M8x12	5	217	13	272.5	14

C	D	E	F	G	M	N	N1	N2	N4	X	2x		3x				
											P		P				
F 20 2/3	SC 60A	M6	15 Nm	102	7	12.5	12.5	11	82	75	60	M5x10	4	196	12	251.5	13
F 20 2/3	SC 60B	M6	15 Nm	102	7	12.5	12.5	14	82	75	60	M5x10	4	196	13	251.5	14
F 20 2/3	SC 80A	M6	15 Nm	115	6	12.5	12.5	14	90	100	80	M6x12	4	196	13	251.5	14
F 20 2/3	SC 80C	M6	15 Nm	120	15.5	14.5	17.75	19	96	100	80	M6x12	4	240.5	14	296	15
F 20 2/3	SC 95A	M6	15 Nm	130	16.5	15	17.75	14	102	115	95	M8x16	4	240.5	14	296	15
F 20 2/3	SC 95B	M6	15 Nm	130	16.5	15	17.75	19	102	115	95	M8x16	4	240.5	14	296	15
F 20 2/3	SC 95C	M6	15 Nm	130	16.5	15	17.75	24	102	115	95	M8x16	4	240.5	14	296	15
F 20 2/3	SC 110A	M6	15 Nm	150	16.5	16	17.75	19	120	130	110	M8x16	5	240.5	15	296	16
F 20 2/3	SC 110B	M6	15 Nm	150	16.5	16	17.75	24	120	130	110	M8x16	5	240.5	15	296	16

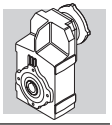

F 20...H

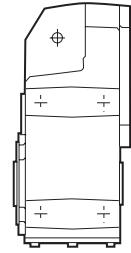
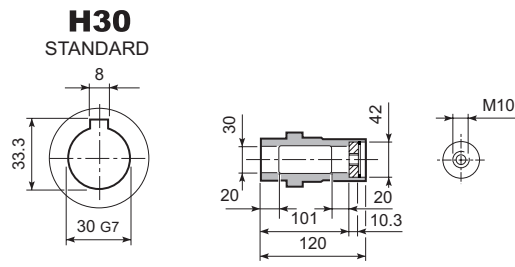

F 20...S

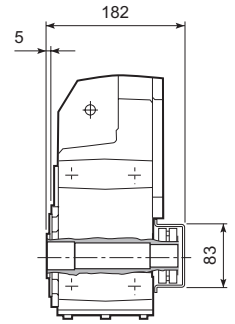
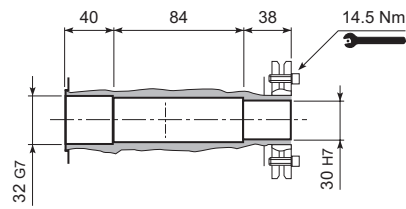

F 20...R

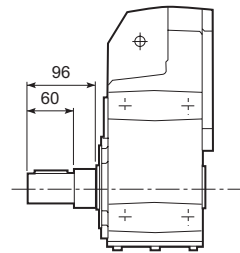
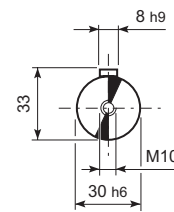

F 20...QF

	Ø
QF25	25
QF30	30

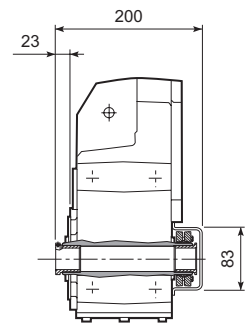
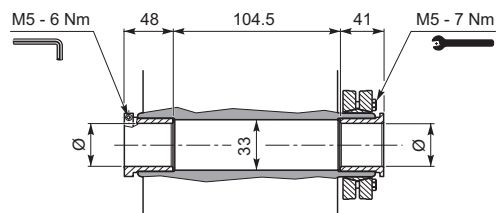

F 20...F...

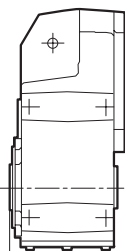
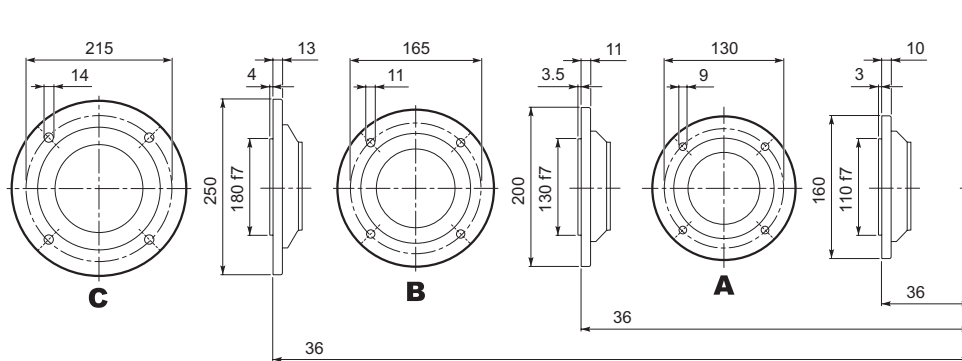

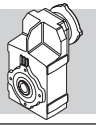

F 25...M

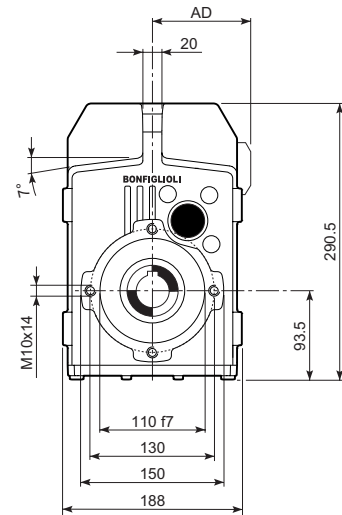
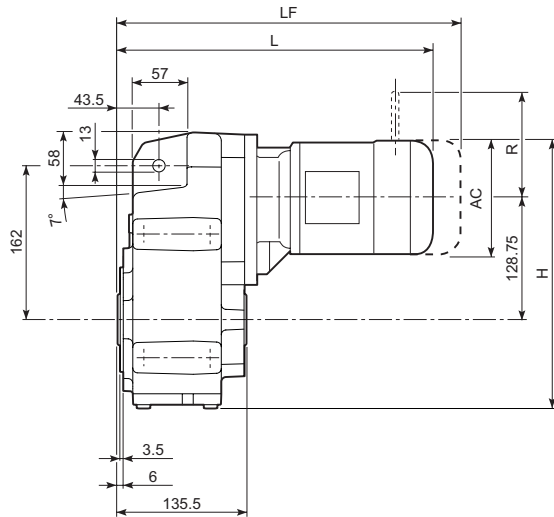

								M_FD M_FA		M_FD		M_FA	
			AC	H	L	AD		LF		R	AD	R	AD
F 25 2/3	S05	M05	121	283	339	95	15	405	17	96	119	116	95
F 25 2/3	S1	M1S	138	291.5	344	108	16	407	19	103	132	124	108
F 25 2/3	S1	M1L	138	291.5	368	108	17	429	20	103	132	124	108
F 25 2/3	S2	M2S	156	300.5	397	119	21	467	25	129	143	134	119
F 25 2/3	S3	M3S	195	320	440	142	26	536	33	160	155	160	142
F 25 2/3	S3	M3L	195	320	472	142	31	563	38	160	155	160	142
F 25 4	S05	M05	121	283	394.5	95	17	460.5	18	96	119	116	95
F 25 4	S1	M1S	138	291.5	399.5	108	18	462.5	20	103	132	124	108
F 25 4	S1	M1L	138	291.5	423.5	108	19	484.5	21	103	132	124	108
F 25 4	S2	M2S	156	300.5	452.5	119	22	522.5	26	129	143	134	119
F 25 4	S3	M3S	195	320	495.5	142	27	591.5	34	160	155	160	142
F 25 4	S3	M3L	195	320	527.5	142	32	618.5	39	160	155	160	142

F 25...P(IEC)

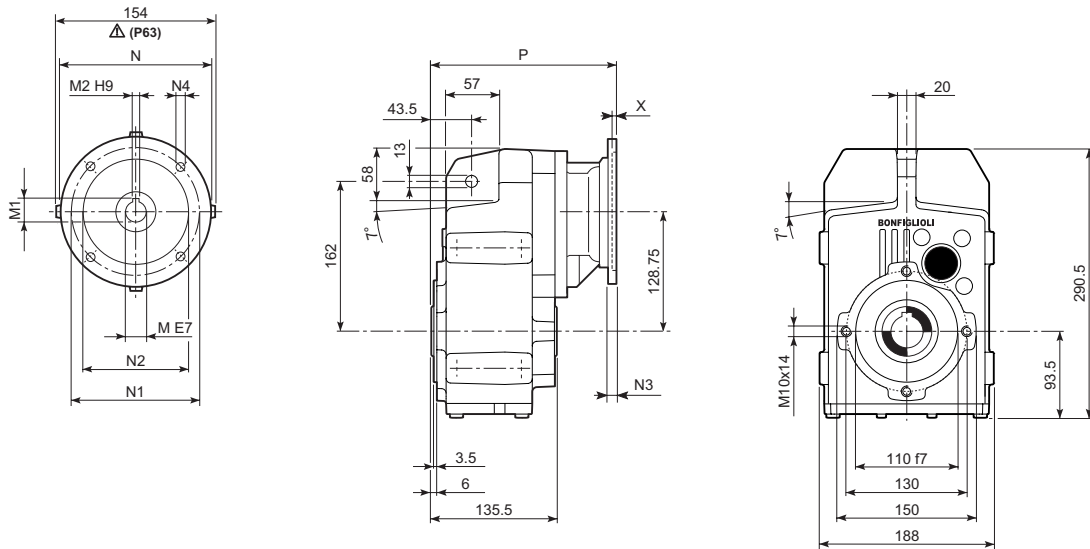
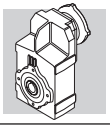

		M	M1	M2	N	N1	N2	N3	N4	X	P	
F 25 2/3	P63	11	12.8	4	140	115	95	—	M8x19	4	213	12
F 25 2/3	P71	14	16.3	5	160	130	110	—	M8x16	4.5	213	12
F 25 2/3	P80	19	21.8	6	200	165	130	—	M10x12	4	232.5	13
F 25 2/3	P90	24	27.3	8	200	165	130	—	M10x12	4	232.5	13
F 25 2/3	P100	28	31.3	8	250	215	180	—	M12x16	4.5	242.5	16
F 25 2/3	P112	28	31.3	8	250	215	180	—	M12x16	4.5	242.5	16
F 25 4	P63	11	12.8	4	140	115	95	—	M8x19	4	268.5	13
F 25 4	P71	14	16.3	5	160	130	110	—	M8x16	4.5	268.5	13
F 25 4	P80	19	21.8	6	200	165	130	—	M10x12	4	288	14
F 25 4	P90	24	27.3	8	200	165	130	—	M10x12	4	288	14
F 25 4	P100	28	31.3	8	250	215	180	—	M12x16	4.5	298	18
F 25 4	P112	28	31.3	8	250	215	180	—	M12x16	4.5	298	18

F 25...HS

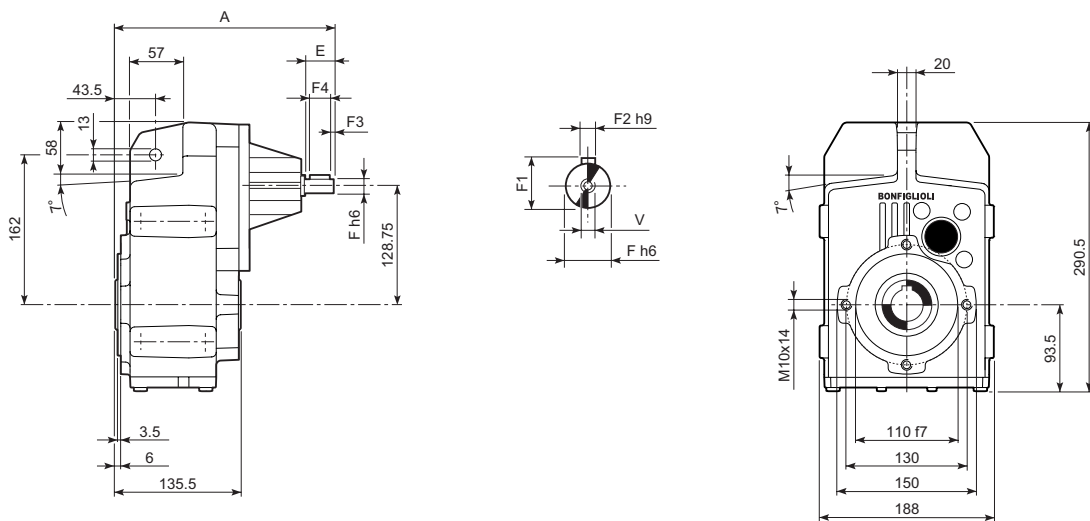

		A	E	F	F1	F2	F3	F4	V	
F 25 2	HS	263	40	19	21.5	6	2.5	35	M6x16	11.5
F 25 3		263	40	19	21.5	6	2.5	35	M6x16	11.5
F 25 4		275.5	40	16	18	5	2.5	35	M6x16	12.5

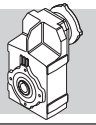

F 25...SK / SC

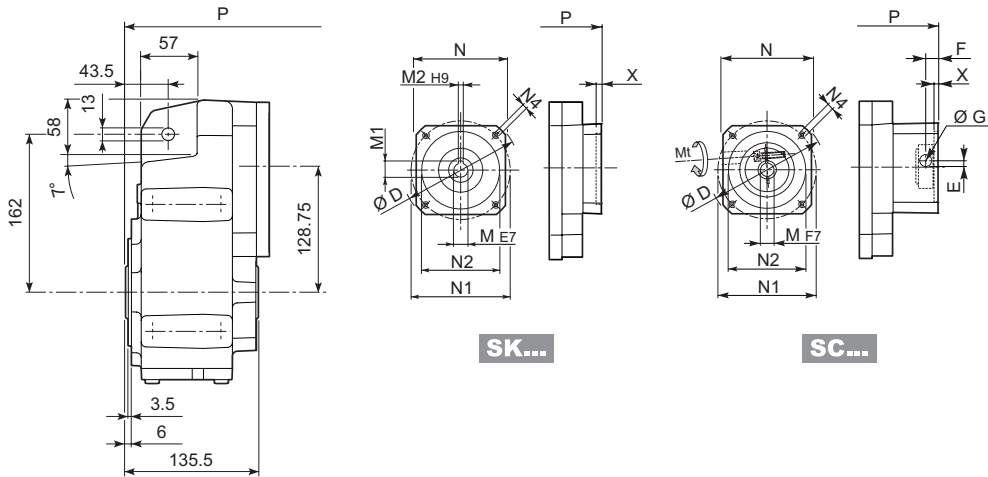

SK...

SC...

C	I	D	M	M1	M2	N	N1	N2	N4	X	2/3x		4x	
											P		P	
F 25 2/3/4	SK 60A	102	11	12.8	4	82	75	60	M5x10	3.5	184.5	11	240	12
F 25 2/3/4	SK 60B	102	14	16.3	5	82	75	60	M5x10	4	191.5	12	247	13
F 25 2/3/4	SK 80A	115	14	16.3	5	90	100	80	M6x12	4	191.5	12	247	13
F 25 2/3/4	SK 80C	120	19	21.8	6	96	100	80	M6x12	4	232.5	13	288	14
F 25 2/3/4	SK 95A	130	14	16.3	5	102	115	95	M8x12	4	232.5	13	288	14
F 25 2/3/4	SK 95B	130	19	21.8	6	102	115	95	M8x12	4	232.5	13	288	14
F 25 2/3/4	SK 95C	130	24	27.3	8	102	115	95	M8x12	4	232.5	13	288	14
F 25 2/3/4	SK 110A	150	19	21.8	6	120	130	110	M8x12	5	232.5	13	288	14
F 25 2/3/4	SK 110B	150	24	27.3	8	120	130	110	M8x12	5	232.5	13	288	14

C	I		Mt	D	E	F	G	M	N	N1	N2	N4	X	2/3x		4x	
														P		P	
F 25 2/3/4	SC 60A	M6	15 Nm	102	7	12.5	12.5	11	82	75	60	M5x10	4	211.5	12	267	13
F 25 2/3/4	SC 60B	M6	15 Nm	102	7	12.5	12.5	14	82	75	60	M5x10	4	211.5	13	267	14
F 25 2/3/4	SC 80A	M6	15 Nm	115	6	12.5	12.5	14	90	100	80	M6x12	4	211.5	13	267	14
F 25 2/3/4	SC 80C	M6	15 Nm	120	15.5	14.5	17.75	19	96	100	80	M6x12	4	256	14	311.5	15
F 25 2/3/4	SC 95A	M6	15 Nm	130	16.5	15	17.75	14	102	115	95	M8x16	4	256	14	311.5	15
F 25 2/3/4	SC 95B	M6	15 Nm	130	16.5	15	17.75	19	102	115	95	M8x16	4	256	14	311.5	15
F 25 2/3/4	SC 95C	M6	15 Nm	130	16.5	15	17.75	24	102	115	95	M8x16	4	256	14	311.5	15
F 25 2/3/4	SC 110A	M6	15 Nm	150	16.5	16	17.75	19	120	130	110	M8x16	5	256	15	311.5	16
F 25 2/3/4	SC 110B	M6	15 Nm	150	16.5	16	17.75	24	120	130	110	M8x16	5	256	15	311.5	16

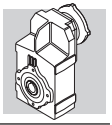

F 25...H

H35 STANDARD

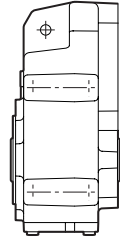
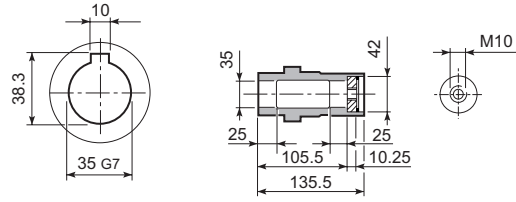

F 25...S

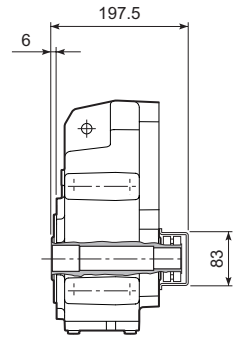
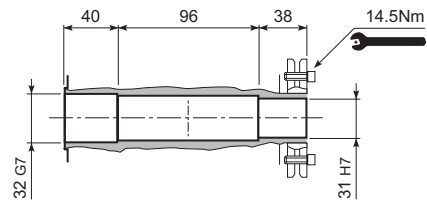

F 25...R

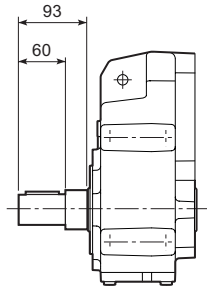
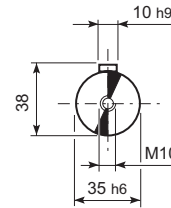

F 25...QF

	Ø
QF30	30
QF32	32

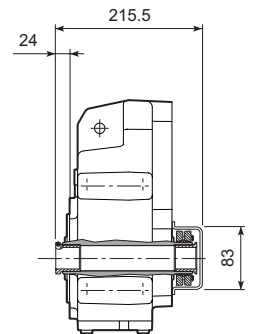
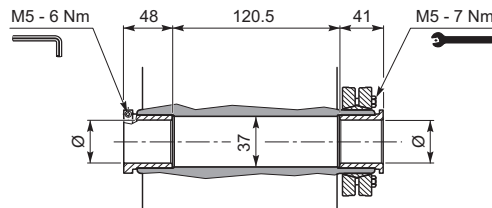

F 25...F...

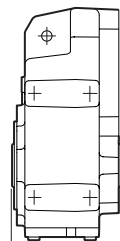
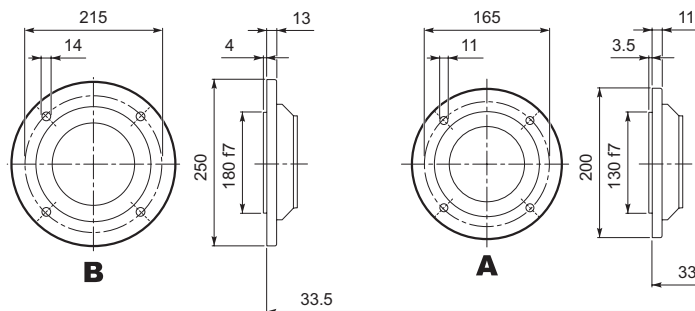

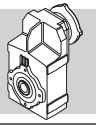

F 31...M

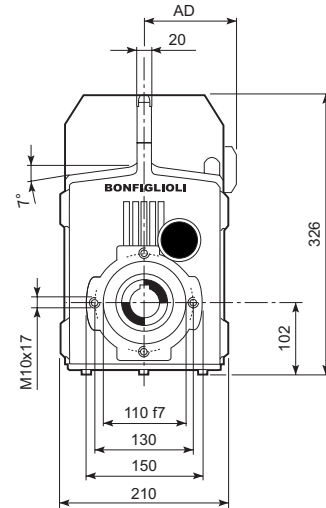
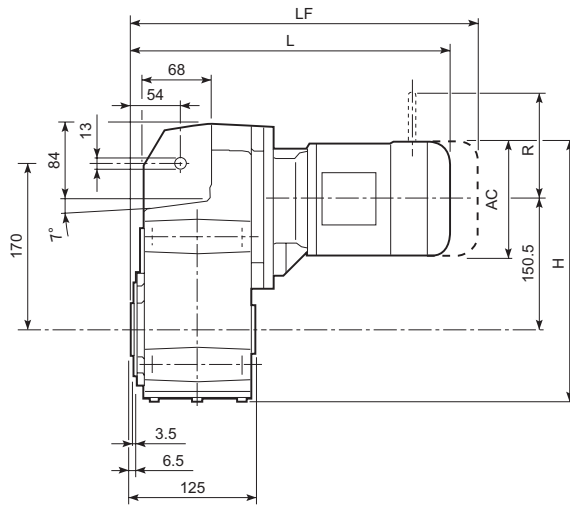

C	D	E	AC	H	L	AD	Kg	M_FD M_FA		M_FD		M_FA	
								LF	Kg	R	AD	R	AD
F 31 2/3	S1	M1S	138	321.3	356.5	108	21	419.5	23	103	132	124	108
F 31 2/3	S1	M1L	138	321.3	380.5	108	22	441.5	25	103	132	124	108
F 31 2/3	S2	M2S	156	330.3	409.5	119	26	479.5	30	129	143	134	119
F 31 2/3	S3	M3S	195	349.8	452.5	142	31	548.5	38	160	155	160	142
F 31 2/3	S3	M3L	195	349.8	484.5	142	38	575.5	45	160	155	160	142
F 31 4	S05	M05	121	312.8	409	95	20	475	22	96	119	116	95
F 31 4	S1	M1S	138	321.3	414	108	21	477	24	103	132	124	108
F 31 4	S1	M1L	138	321.3	438	108	22	499	25	103	132	124	108
F 31 4	S2	M2S	156	330.3	467	119	26	537	31	129	143	134	119
F 31 4	S3	M3S	195	349.8	510	142	31	606	39	160	155	160	142
F 31 4	S3	M3L	195	349.8	542	142	38	633	46	160	155	160	142

F 31...P(IEC)

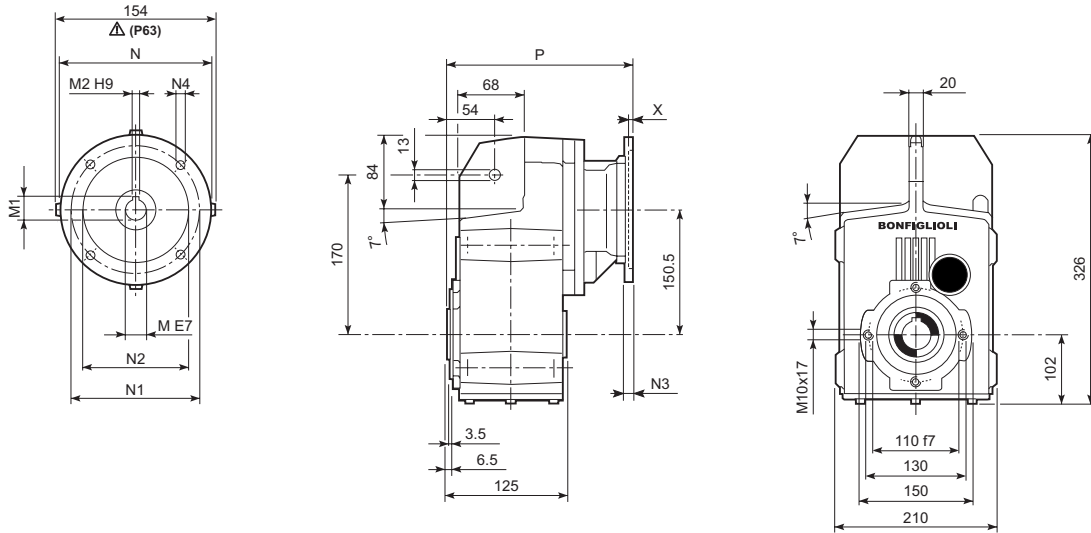
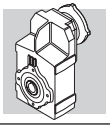

		M	M1	M2	N	N1	N2	N3	N4	X	P			
		F 31 2/3	P63	11	12.8	4	140	115	95	—	M8x19	4	225.5	17
		F 31 2/3	P71	14	16.3	5	160	130	110	—	M8x16	4.5	225.5	17
		F 31 2/3	P80	19	21.8	6	200	165	130	—	M10x12	4	245	18
		F 31 2/3	P90	24	27.3	8	200	165	130	—	M10x12	4	245	17
		F 31 2/3	P100	28	31.3	8	250	215	180	—	M12x16	4.5	255	21
		F 31 2/3	P112	28	31.3	8	250	215	180	—	M12x16	4.5	255	21
		F 31 4	P63	11	12.8	4	140	115	95	—	M8x19	4	283	17
		F 31 4	P71	14	16.3	5	160	130	110	—	M8x16	4.5	283	17
		F 31 4	P80	19	21.8	6	200	165	130	—	M10x12	4	302.5	18
		F 31 4	P90	24	27.3	8	200	165	130	—	M10x12	4	302.5	18
		F 31 4	P100	28	31.3	8	250	215	180	—	M12x16	4.5	312.5	22
		F 31 4	P112	28	31.3	8	250	215	180	—	M12x16	4.5	312.5	22

F 31...HS

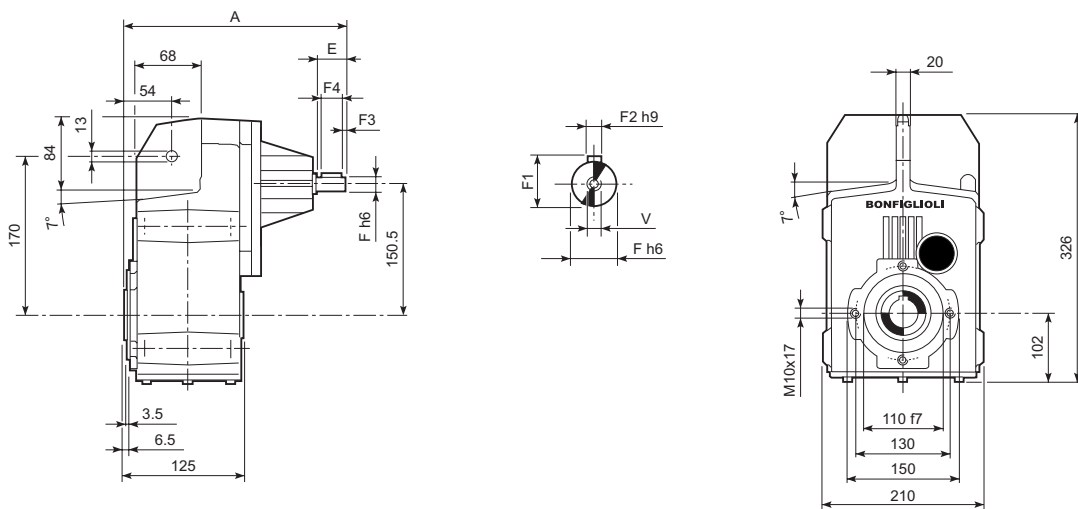

		A	E	F	F1	F2	F3	F4	V		
		F 31 2	275.5	40	19	21.5	6	2.5	35	M6x16	16.7
		F 31 3	275.5	40	19	21.5	6	2.5	35	M6x16	16.7
		F 31 4	290	40	16	18	5	2.5	35	M6x16	16.5

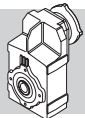

F 31...SK / SC

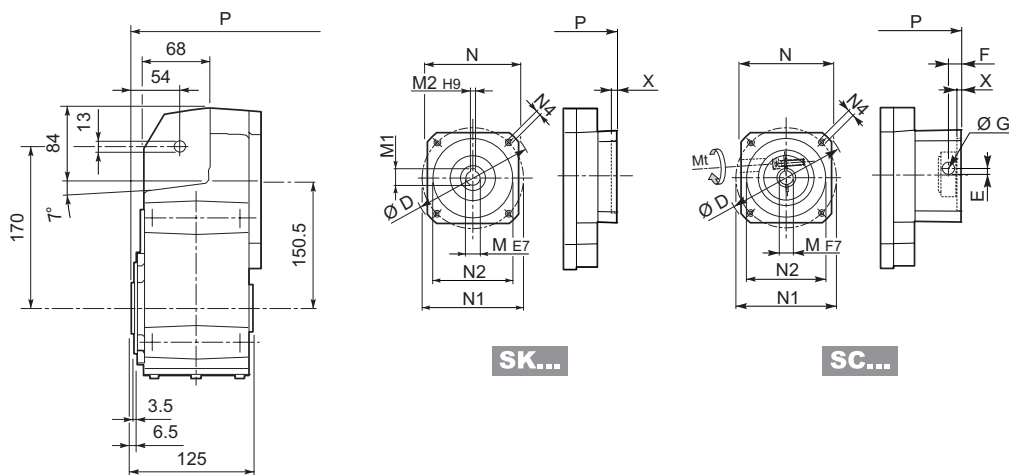

SK...

SC...

C	D	M	M1	M2	N	N1	N2	N4	X	2/3x		4x	
										P		P	
F 31 2/3/4 SK 60A	102	11	12.8	4	82	75	60	M5x10	3.5	197	16	254.5	16
F 31 2/3/4 SK 60B	102	14	16.3	5	82	75	60	M5x10	4	204	17	261.5	17
F 31 2/3/4 SK 80A	115	14	16.3	5	90	100	80	M6x12	4	204	17	261.5	17
F 31 2/3/4 SK 80C	120	19	21.8	6	96	100	80	M6x12	4	245	18	302.5	18
F 31 2/3/4 SK 95A	130	14	16.3	5	102	115	95	M8x12	4	245	18	302.5	18
F 31 2/3/4 SK 95B	130	19	21.8	6	102	115	95	M8x12	4	245	18	302.5	18
F 31 2/3/4 SK 95C	130	24	27.3	8	102	115	95	M8x12	4	245	18	302.5	18
F 31 2/3/4 SK 110A	150	19	21.8	6	120	130	110	M8x12	5	245	18	302.5	18
F 31 2/3/4 SK 110B	150	24	27.3	8	120	130	110	M8x12	5	245	18	302.5	18
F 31 2/3 SK 130A	188	24	27.3	8	142	165	130	M10x20	5	245	18	—	—

C	D	M	Mt	D	E	F	G	M	N	N1	N2	N4	X	2/3x		4x	
														P		P	
F 31 2/3/4 SC 60A	M6	15 Nm	102	7	12.5	12.5	11	82	75	60	M5x10	4	224	17	281.5	17	
F 31 2/3/4 SC 60B	M6	15 Nm	102	7	12.5	12.5	14	82	75	60	M5x10	4	224	18	281.5	18	
F 31 2/3/4 SC 80A	M6	15 Nm	115	6	12.5	12.5	14	90	100	80	M6x12	4	224	18	281.5	18	
F 31 2/3/4 SC 80C	M6	15 Nm	120	15.5	14.5	17.75	19	96	100	80	M6x12	4	268.5	19	326	19	
F 31 2/3/4 SC 95A	M6	15 Nm	130	16.5	15	17.75	14	102	115	95	M8x16	4	268.5	19	326	19	
F 31 2/3/4 SC 95B	M6	15 Nm	130	16.5	15	17.75	19	102	115	95	M8x16	4	268.5	19	326	19	
F 31 2/3/4 SC 95C	M6	15 Nm	130	16.5	15	17.75	24	102	115	95	M8x16	4	268.5	19	326	19	
F 31 2/3/4 SC 110A	M6	15 Nm	150	16.5	16	17.75	19	120	130	110	M8x16	5	268.5	20	326	20	
F 31 2/3/4 SC 110B	M6	15 Nm	150	16.5	16	17.75	24	120	130	110	M8x16	5	268.5	20	326	20	
F 31 2/3 SC 130A	M6	15 Nm	188	19	16	17.75	24	142	165	130	M10x20	5	268.5	21	—	—	

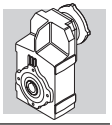

F 31...H

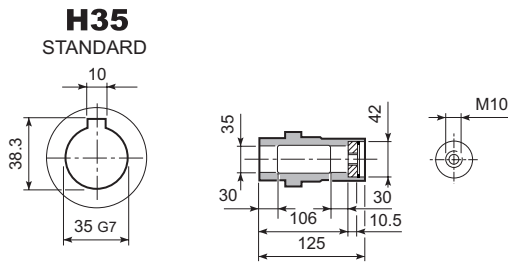

F 31...S

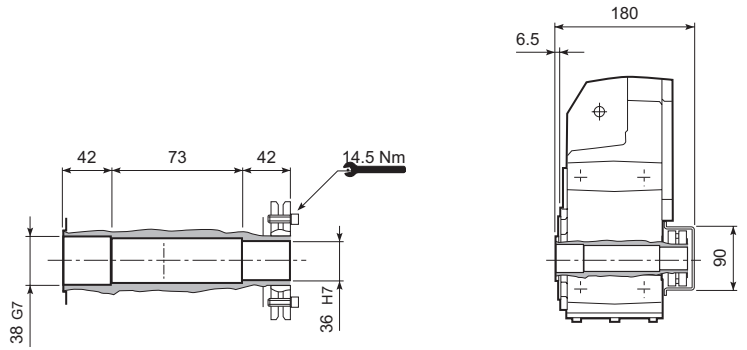

F 31...R

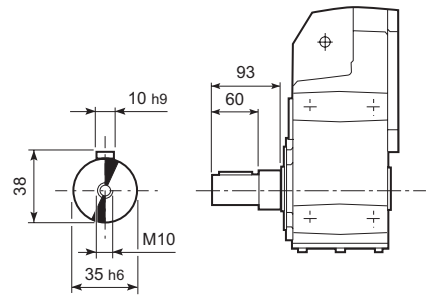

F 31...QF

	Ø
QF35	35
QF40	40

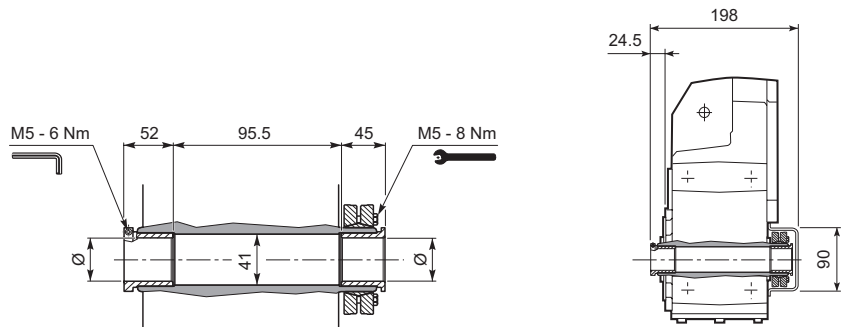

F 31...F...

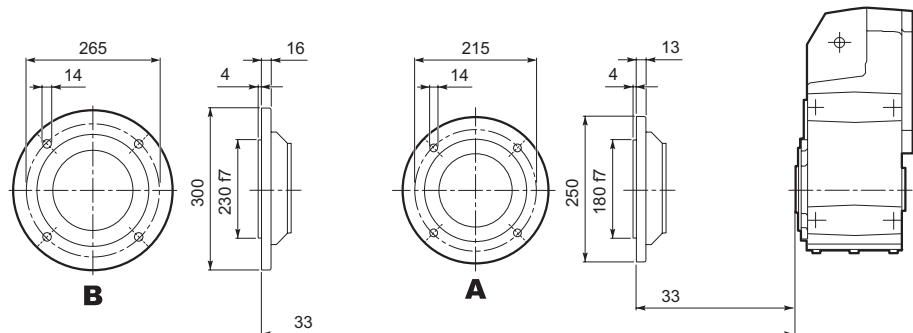

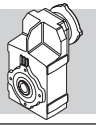

F 41...M

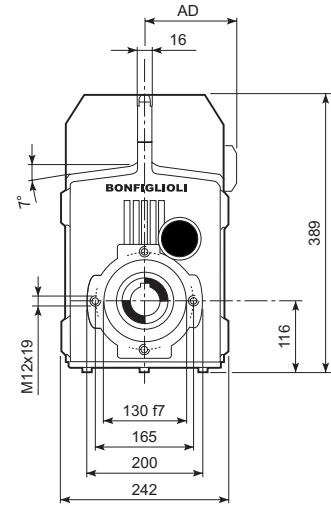
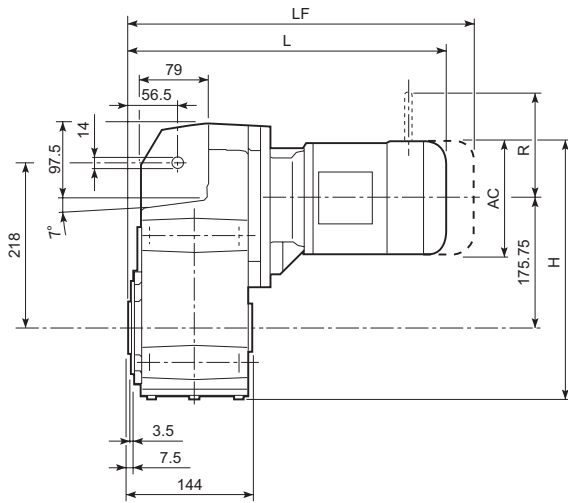

C	D	E						M_FD M_FA		M_FD		M_FA	
			AC	H	L	AD		LF		R	AD	R	AD
F 41 2/3	S1	M1S	138	360.8	377	108	44	440	47	103	132	124	108
F 41 2/3	S1	M1L	138	360.8	401	108	46	462	48	103	132	124	108
F 41 2/3	S2	M2S	156	369.8	430	119	49	500	53	129	143	134	119
F 41 2/3	S3	M3S	195	389.3	473	142	54	569	62	160	155	160	142
F 41 2/3	S3	M3L	195	389.3	505	142	62	596	69	160	155	160	142
F 41 2/3	S4	M4	258	420.8	613	193	96	722	114	226	193	217	193
F 41 2/3	S4	M4LC	258	420.8	648	193	104	747	122	226	193	217	193
F 41 4	S05	M05	231	352.3	433.5	95	45	499.5	46	96	119	116	95
F 41 4	S1	M1S	138	360.8	438.5	108	45	501.5	48	103	132	124	108
F 41 4	S1	M1L	138	360.8	462.5	108	47	523.5	49	103	132	124	108
F 41 4	S2	M2S	156	369.8	491.5	119	50	561.5	58	129	143	134	119
F 41 4	S3	M3S	195	389.3	534.5	142	55	630.5	62	160	155	160	142
F 41 4	S3	M3L	195	389.3	566.5	142	63	657.5	70	160	155	160	142

F 41...P(IEC)

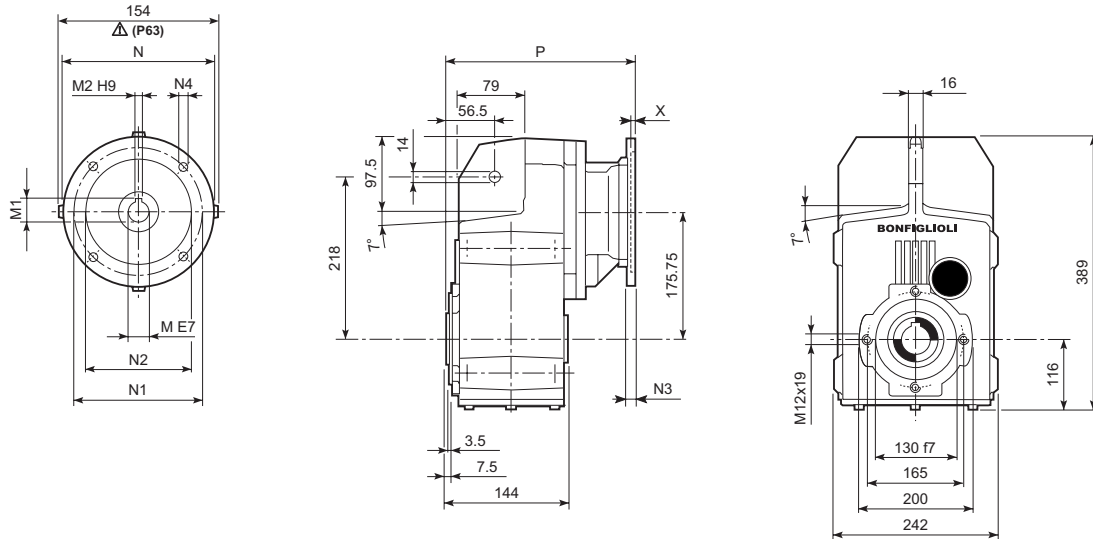
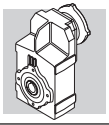

		M	M1	M2	N	N1	N2	N3	N4	X	P			
		F 41 2/3	P63	11	12.8	4	140	115	95	—	M8x19	4	246	42
		F 41 2/3	P71	14	16.3	5	160	130	110	—	M8x16	4.5	246	42
		F 41 2/3	P80	19	21.8	6	200	165	130	—	M10x12	4	265.5	43
		F 41 2/3	P90	24	27.3	8	200	165	130	—	M10x12	4	265.5	43
		F 41 2/3	P100	28	31.3	8	250	215	180	—	M12x16	4.5	275.5	47
		F 41 2/3	P112	28	31.3	8	250	215	180	—	M12x16	4.5	275.5	47
		F 41 2/3	P132	38	41.3	10	300	265	230	16	14	5	312	50
		F 41 4	P63	11	12.8	4	140	115	95	—	M8x19	4	307.5	44
		F 41 4	P71	14	16.3	5	160	130	110	—	M8x16	4.5	307.5	44
		F 41 4	P80	19	21.8	6	200	165	130	—	M10x12	4	327	45
		F 41 4	P90	24	27.3	8	200	165	130	—	M10x12	4	327	45
		F 41 4	P100	28	31.3	8	250	215	180	—	M12x16	4.5	337	49
		F 41 4	P112	28	31.3	8	250	215	180	—	M12x16	4.5	337	49

F 41...HS

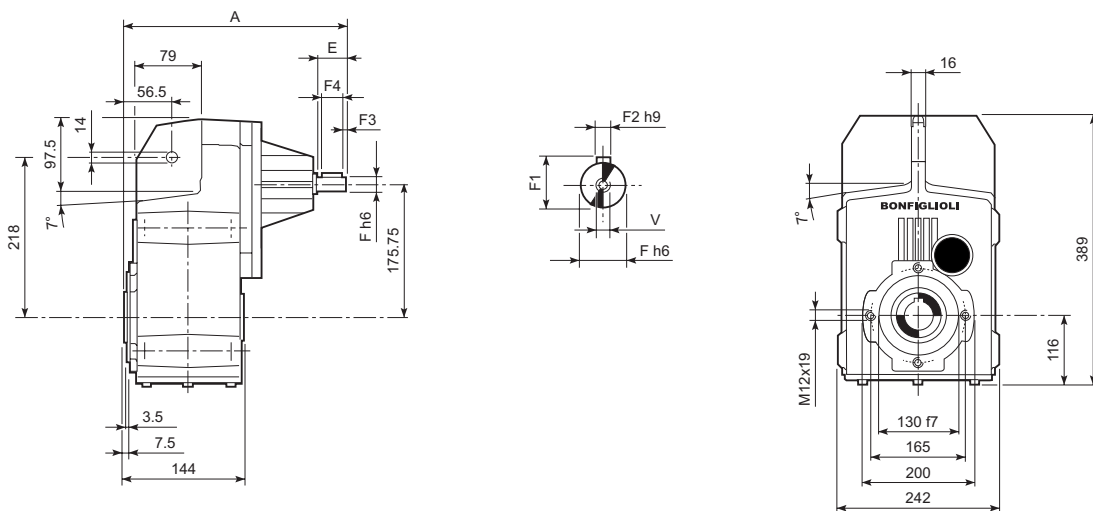

		A	E	F	F1	F2	F3	F4	V			
		F 41 2	HS	335.5	50	24	27	8	2.5	45	M8x19	44.9
		F 41 3		335.5	50	24	27	8	2.5	45	M8x19	46.4
		F 41 4		357.5	40	19	21.5	6	2.5	35	M6x16	43.5

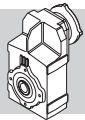

F 41...SK / SC

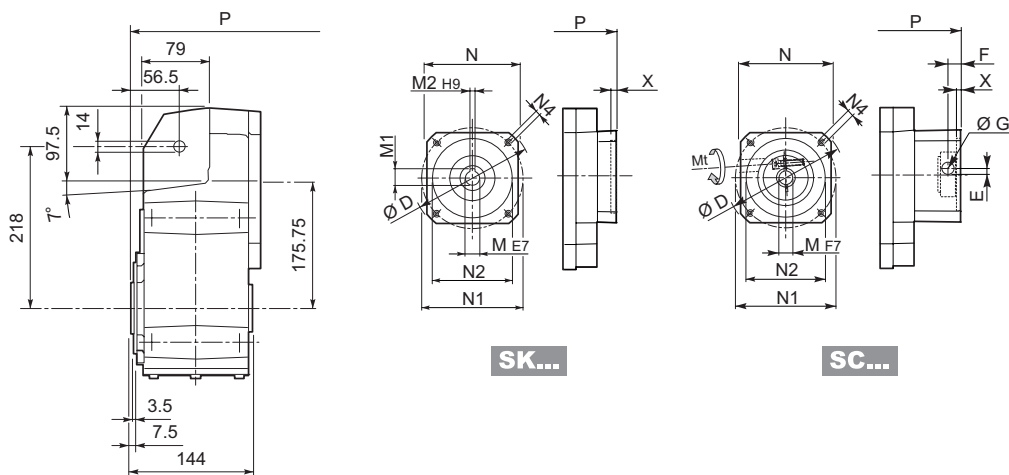

SK...

SC...

C	I	D	M	M1	M2	N	N1	N2	N4	X	2/3x		4x	
											P		P	
F 41 4	SK 60A	102	11	12.8	4	82	75	60	M5x10	3.5	—	—	279	43
F 41 4	SK 60B	102	14	16.3	5	82	75	60	M5x10	4	—	—	286	44
F 41 4	SK 80A	115	14	16.3	5	90	100	80	M6x12	4	—	—	286	44
F 41 2/3	SK 80B	120	14	16.3	5	96	100	80	M6x12	4	265.5	43	—	—
F 41 2/3/4	SK 80C	120	19	21.8	6	96	100	80	M6x12	4	265.5	43	327	45
F 41 2/3/4	SK 95A	130	14	16.3	5	102	115	95	M8x12	4	265.5	43	327	45
F 41 2/3/4	SK 95B	130	19	21.8	6	102	115	95	M8x12	4	265.5	43	327	45
F 41 2/3/4	SK 95C	130	24	27.3	8	102	115	95	M8x12	4	265.5	43	327	45
F 41 2/3/4	SK 110A	150	19	21.8	6	120	130	110	M8x12	5	265.5	43	327	45
F 41 2/3/4	SK 110B	150	24	27.3	8	120	130	110	M8x12	5	265.5	43	327	45
F 41 2/3	SK 130A	188	24	27.3	8	142	165	130	M10x20	5	265.5	45	—	—
F 41 2/3	SK 130B	189	32	35.3	10	160	165	130	M10x20	5	312	47	—	—
F 41 2/3	SK 180A	240	32	35.3	10	192	215	180	M12x19	5	312	47	—	—
F 41 2/3	SK 180B	240	38	41.3	10	192	215	180	M12x19	5	312	47	—	—

C	I		Mt	D	E	F	G	M	N	N1	N2	N4	X	2/3x		4x	
														P		P	
F 41 4	SC 60A	M6	15 Nm	102	7	12.5	12.5	11	82	75	60	M5x10	4	—	—	306	44
F 41 4	SC 60B	M6	15 Nm	102	7	12.5	12.5	14	82	75	60	M5x10	4	—	—	306	45
F 41 4	SC 80A	M6	15 Nm	115	6	12.5	12.5	14	90	100	80	M6x12	4	—	—	306	45
F 41 2/3	SC 80B	M6	15 Nm	120	15.5	14.5	17.75	14	96	100	80	M6x12	4	289	44	—	—
F 41 2/3/4	SC 80C	M6	15 Nm	120	15.5	14.5	17.75	19	96	100	80	M6x12	4	289	44	350.5	46
F 41 2/3/4	SC 95A	M6	15 Nm	130	16.5	15	17.75	14	102	115	95	M8x16	4	289	44	350.5	46
F 41 2/3/4	SC 95B	M6	15 Nm	130	16.5	15	17.75	19	102	115	95	M8x16	4	289	44	350.5	46
F 41 2/3/4	SC 95C	M6	15 Nm	130	16.5	15	17.75	24	102	115	95	M8x16	4	289	44	350.5	46
F 41 2/3/4	SC 110A	M6	15 Nm	150	16.5	16	17.75	19	120	130	110	M8x16	5	289	45	350.5	47
F 41 2/3/4	SC 110B	M6	15 Nm	150	16.5	16	17.75	24	120	130	110	M8x16	5	289	45	350.5	47
F 41 2/3	SC 130A	M6	15 Nm	188	19	16	17.75	24	142	165	130	M10x20	5	289	46	—	—
F 41 2/3	SC 130B	M8	36 Nm	189	20	17	17.75	32	160	165	130	M10x20	5	335	50	—	—
F 41 2/3	SC 180A	M8	36 Nm	240	20	17.5	17.75	32	192	215	180	M12x24	5	339	50	—	—
F 41 2/3	SC 180B	M8	36 Nm	240	20	17.5	17.75	38	192	215	180	M12x24	5	339	50	—	—

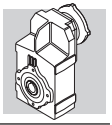

F 41...H

H40 STANDARD

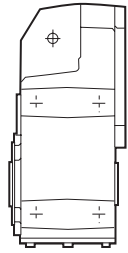
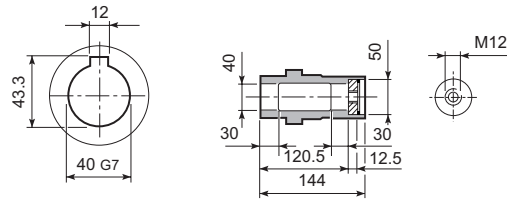

F 41...S

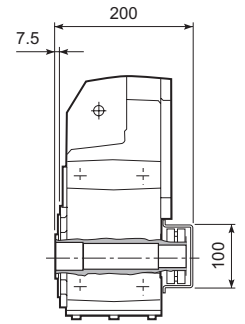
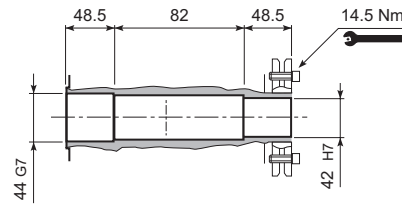

F 41...R

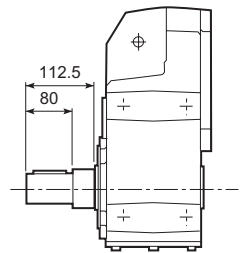
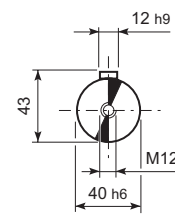

F 41...QF

	Ø
QF42	42
QF45	45

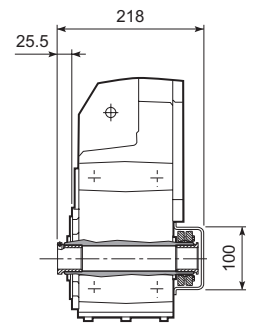
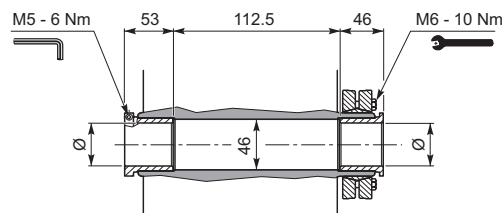

F 41...F...

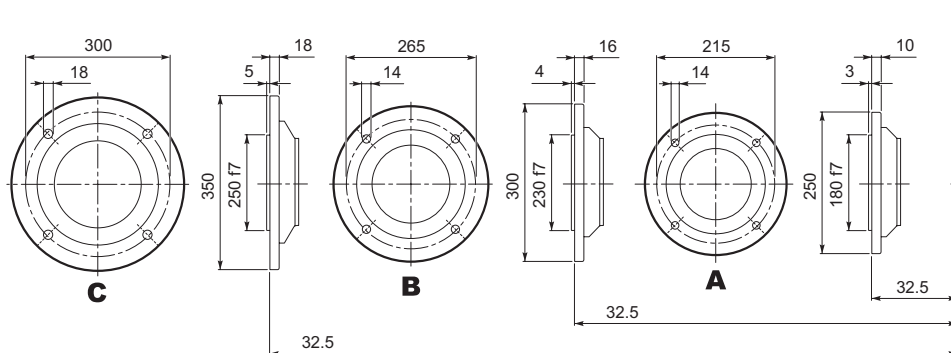

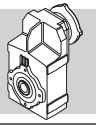

F 51...M

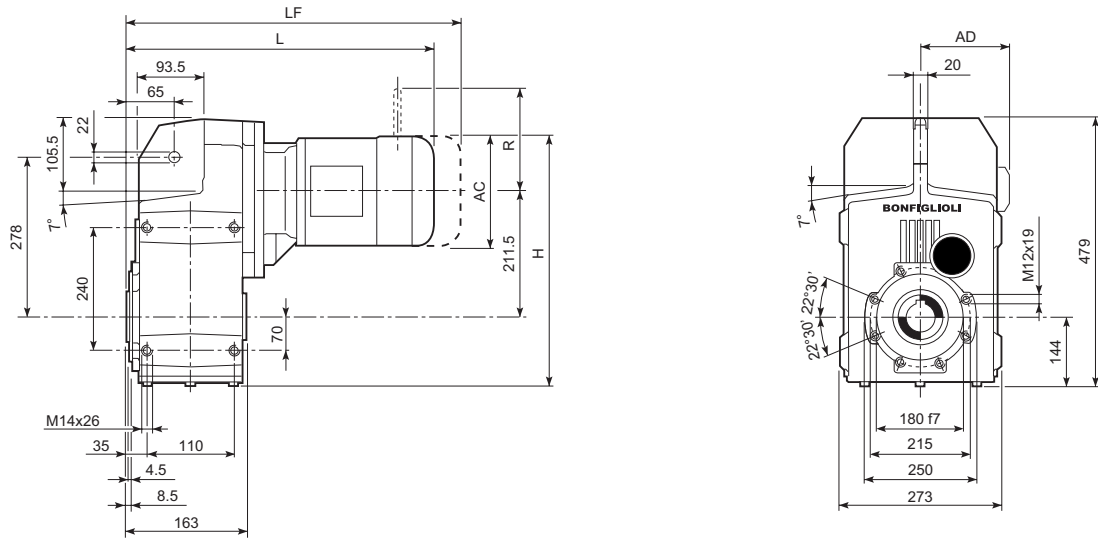

C	D	E	AC	H	L	AD	K	M_FD M_FA		M_FD		M_FA	
								LF	K	R	AD	R	AD
F 51 2/3	S1	M1S	138	424	399	108	72	462	75	103	132	124	108
F 51 2/3	S1	M1L	138	424	423	108	73	484	76	103	132	124	108
F 51 2/3	S2	M2S	156	433	452	119	73	522	76	129	143	134	119
F 51 2/3	S3	M3S	195	452.5	495	142	77	591	85	160	155	160	142
F 51 2/3	S3	M3L	195	452.5	527	142	85	618	92	160	155	160	142
F 51 2/3	S4	M4	258	484	635	193	119	744	137	226	193	217	193
F 51 2/3	S4	M4LC	258	484	670	193	127	769	145	226	193	217	193
F 51 4	S1	M1S	138	424	470.5	108	74	533.5	77	103	132	124	108
F 51 4	S1	M1L	138	424	494.5	108	75	555.5	78	103	132	124	108
F 51 4	S2	M2S	156	433	523.5	119	79	593.5	83	129	143	134	119
F 51 4	S3	M3S	195	452.5	566.5	142	84	662.5	91	160	155	160	142
F 51 4	S3	M3L	195	452.5	598.5	142	91	689.5	98	160	155	160	142

F 51...P(IEC)

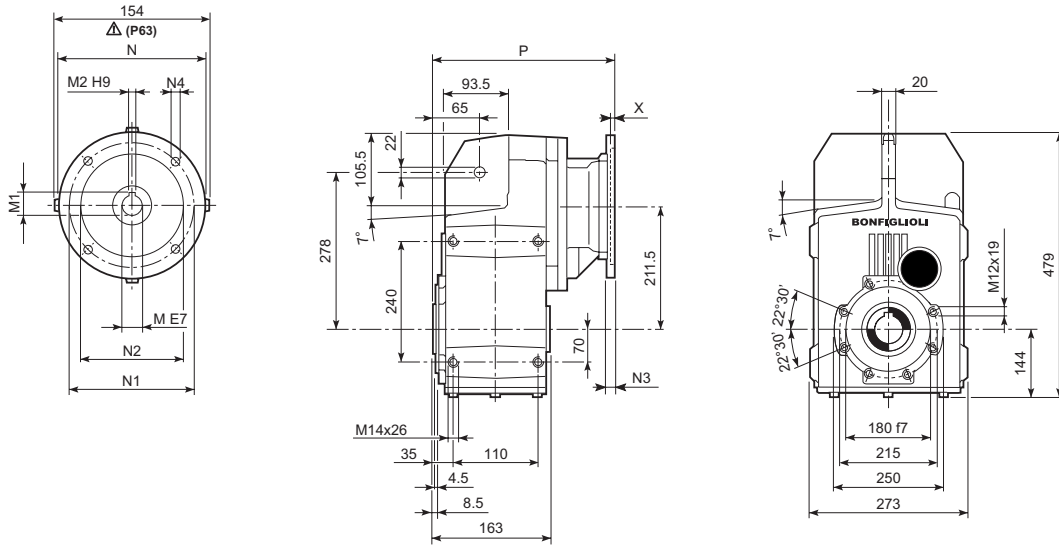
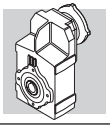

		M	M1	M2	N	N1	N2	N3	N4	X	P	
F 51 2/3	P63	11	12.8	4	140	115	95	—	M8x19	4	268	65
F 51 2/3	P71	14	16.3	5	160	130	110	—	M8x16	4.5	268	65
F 51 2/3	P80	19	21.8	6	200	165	130	—	M10x12	4	287.5	67
F 51 2/3	P90	24	27.3	8	200	165	130	—	M10x12	4	287.5	67
F 51 2/3	P100	28	31.3	8	250	215	180	—	M12x16	4.5	297.5	71
F 51 2/3	P112	28	31.3	8	250	215	180	—	M12x16	4.5	297.5	71
F 51 2/3	P132	38	41.3	10	300	265	230	16	14	5	334	74
F 51 2/3	P160	42	45.3	12	350	300	250	23	18	5.5	384.5	78
F 51 2/3	P180	48	51.8	14	350	300	250	23	18	5.5	384.5	78
F 51 4	P63	11	12.8	4	140	115	95	—	M8x19	4	339.5	70
F 51 4	P71	14	16.3	5	160	130	110	—	M8x16	4.5	339.5	70
F 51 4	P80	19	21.8	6	200	165	130	—	M10x12	4	359	71
F 51 4	P90	24	27.3	8	200	165	130	—	M10x12	4	359	71
F 51 4	P100	28	31.3	8	250	215	180	—	M12x16	4.5	369	75
F 51 4	P112	28	31.3	8	250	215	180	—	M12x16	4.5	369	75

F 51...HS

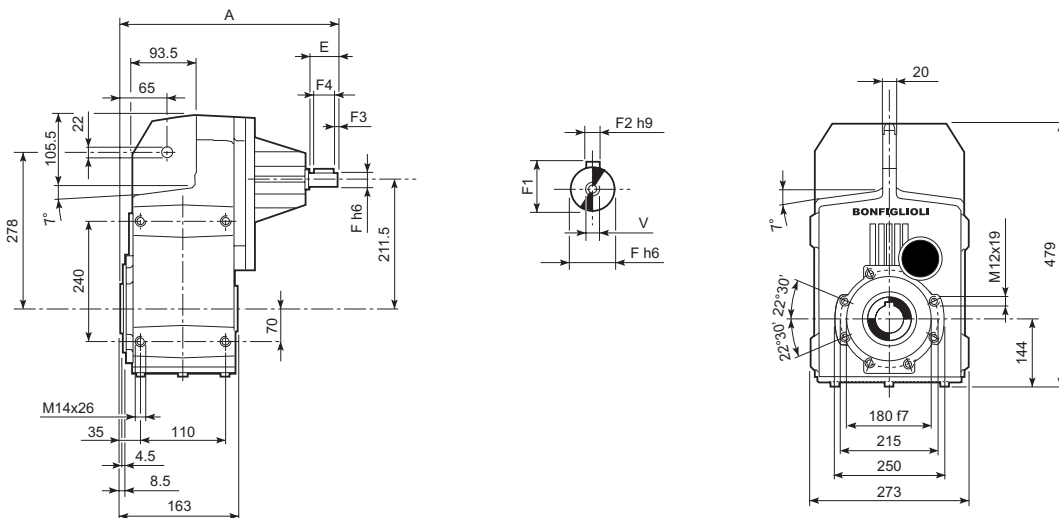

		A	E	F	F1	F2	F3	F4	V	
F 51 2	HS	357.5	50	24	27	8	2.5	45	M8x19	65
F 51 3		357.5	50	24	27	8	2.5	45	M8x19	68
F 51 4		389.5	40	19	21.5	6	2.5	35	M6x16	70

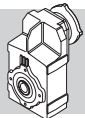

F 51...SK / SC

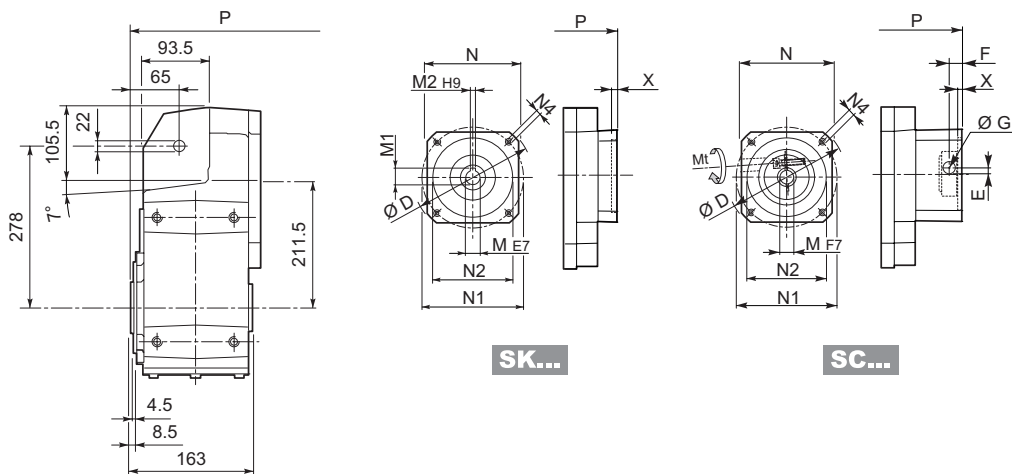

SK...

SC...

C	I	D	M	M1	M2	N	N1	N2	N4	X	2/3x		4x	
											P		P	
F 51 4	SK 60A	102	11	12.8	4	82	75	60	M5x10	3.5	—	—	311	70
F 51 4	SK 60B	102	14	16.3	5	82	75	60	M5x10	4	—	—	318	70
F 51 4	SK 80A	115	14	16.3	5	90	100	80	M6x12	4	—	—	318	70
F 51 2/3	SK 80B	120	14	16.3	5	96	100	80	M6x12	4	287.5	67	—	—
F 51 2/3/4	SK 80C	120	19	21.8	6	96	100	80	M6x12	4	287.5	67	359	71
F 51 2/3/4	SK 95A	130	14	16.3	5	102	115	95	M8x12	4	287.5	67	359	71
F 51 2/3/4	SK 95B	130	19	21.8	6	102	115	95	M8x12	4	287.5	67	359	71
F 51 2/3/4	SK 95C	130	24	27.3	8	102	115	95	M8x12	4	287.5	67	359	71
F 51 2/3/4	SK 110A	150	19	21.8	6	120	130	110	M8x12	5	287.5	67	359	71
F 51 2/3/4	SK 110B	150	24	27.3	8	120	130	110	M8x12	5	287.5	67	359	71
F 51 2/3/4	SK 130A	188	24	27.3	8	142	165	130	M10x20	5	287.5	69	359	73
F 51 2/3	SK 130B	189	32	35.3	10	160	165	130	M10x20	5	334	75	—	—
F 51 2/3	SK 180A	240	32	35.3	10	192	215	180	M12x19	5	334	75	—	—
F 51 2/3	SK 180B	240	38	41.3	10	192	215	180	M12x19	5	334	75	—	—

C	I		Mt	D	E	F	G	M	N	N1	N2	N4	X	2/3x		4x	
														P		P	
F 51 4	SC 60A	M6	15 Nm	102	7	12.5	12.5	11	82	75	60	M5x10	4	—	—	338	70
F 51 4	SC 60B	M6	15 Nm	102	7	12.5	12.5	14	82	75	60	M5x10	4	—	—	338	71
F 51 4	SC 80A	M6	15 Nm	115	6	12.5	12.5	14	90	100	80	M6x12	4	—	—	338	71
F 51 2/3	SC 80B	M6	15 Nm	120	15.5	14.5	17.75	14	96	100	80	M6x12	4	311	70	—	—
F 51 2/3/4	SC 80C	M6	15 Nm	120	15.5	14.5	17.75	19	96	100	80	M6x12	4	311	70	382.5	74
F 51 2/3/4	SC 95A	M6	15 Nm	130	16.5	15	17.75	14	102	115	95	M8x16	4	311	70	382.5	74
F 51 2/3/4	SC 95B	M6	15 Nm	130	16.5	15	17.75	19	102	115	95	M8x16	4	311	70	382.5	74
F 51 2/3/4	SC 95C	M6	15 Nm	130	16.5	15	17.75	24	102	115	95	M8x16	4	311	70	382.5	74
F 51 2/3/4	SC 110A	M6	15 Nm	150	16.5	16	17.75	19	120	130	110	M8x16	5	311	71	382.5	75
F 51 2/3/4	SC 110B	M6	15 Nm	150	16.5	16	17.75	24	120	130	110	M8x16	5	311	71	382.5	75
F 51 2/3/4	SC 130A	M6	15 Nm	188	19	16	17.75	24	142	165	130	M10x20	5	311	72	382.5	76
F 51 2/3	SC 130B	M8	36 Nm	189	20	17	17.75	32	160	165	130	M10x20	5	357	75	—	—
F 51 2/3	SC 180A	M8	36 Nm	240	20	17.5	17.75	32	192	215	180	M12x24	5	361	75	—	—
F 51 2/3	SC 180B	M8	36 Nm	240	20	17.5	17.75	38	192	215	180	M12x24	5	361	75	—	—

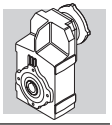

F 51...H

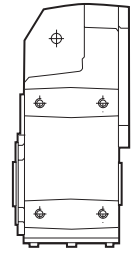
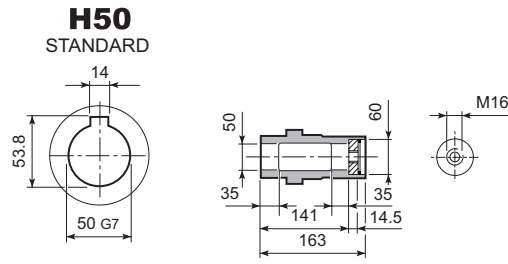

F 51...S

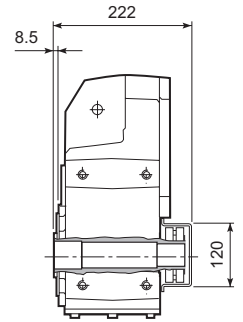
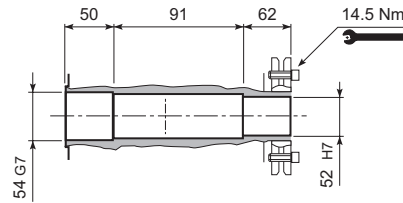

F 51...R

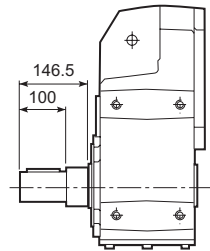
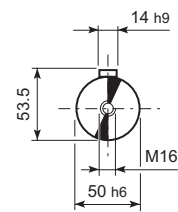

F 51...QF

	Ø
QF50	50
QF55	55

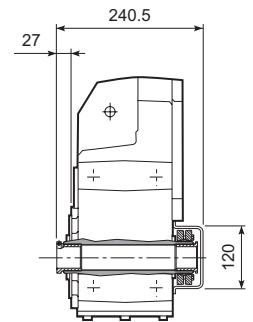
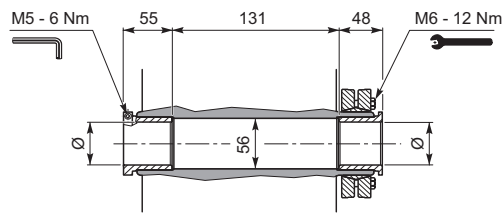

F 51...F...

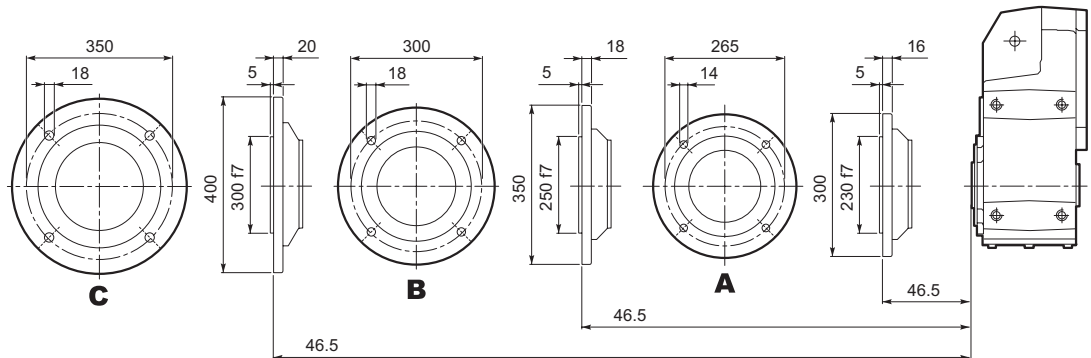

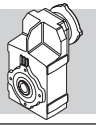

F 60...M

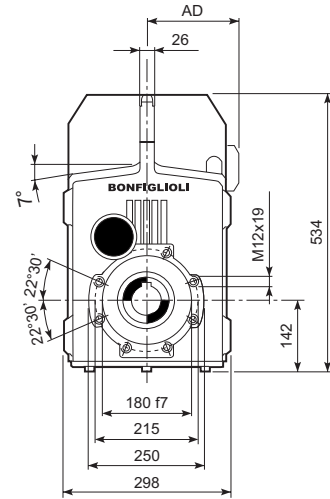
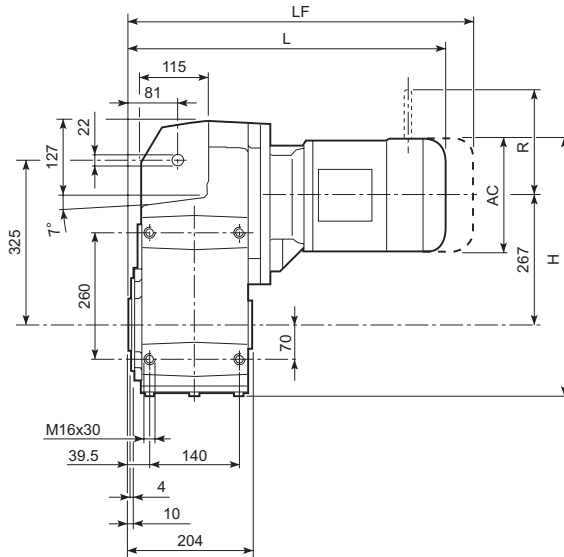

									M_FD M_FA		M_FD		M_FA	
			AC	H	L	AD		LF		R	AD	R	AD	
F 60 3	S2	M2S	156	487	486.5	119	114	556.5	121	129	143	134	119	
F 60 3	S3	M3S	195	506.5	529.5	142	114	625.5	122	160	155	160	142	
F 60 3	S3	M3L	195	506.5	561.5	142	122	652.5	129	160	155	160	142	
F 60 3	S4	M4	258	538	669.5	193	156	777.5	174	226	193	217	193	
F 60 3	S4	M4LC	258	538	704.5	193	164	802.5	182	226	193	217	193	
F 60 3	S5	M5S	310	564	756	245	184	896	214	266	245	247	245	
F 60 3	S5	M5L	310	564	800	245	200	940	230	266	245	247	245	
F 60 4	S1	M1S	138	478	504	108	112	567	114	103	132	124	108	
F 60 4	S1	M1L	138	478	528	108	113	589	116	103	132	124	108	
F 60 4	S2	M2S	156	487	557	119	117	627	121	129	143	134	119	
F 60 4	S3	M3S	195	506.5	600	142	122	696	129	160	155	160	142	
F 60 4	S3	M3L	195	506.5	632	142	129	723	136	160	155	160	142	
F 60 4	S4	M4	258	538	740	193	156	849	174	226	193	217	193	
F 60 4	S4	M4LC	258	538	775	193	164	874	182	226	193	217	193	

F 60...P(IEC)

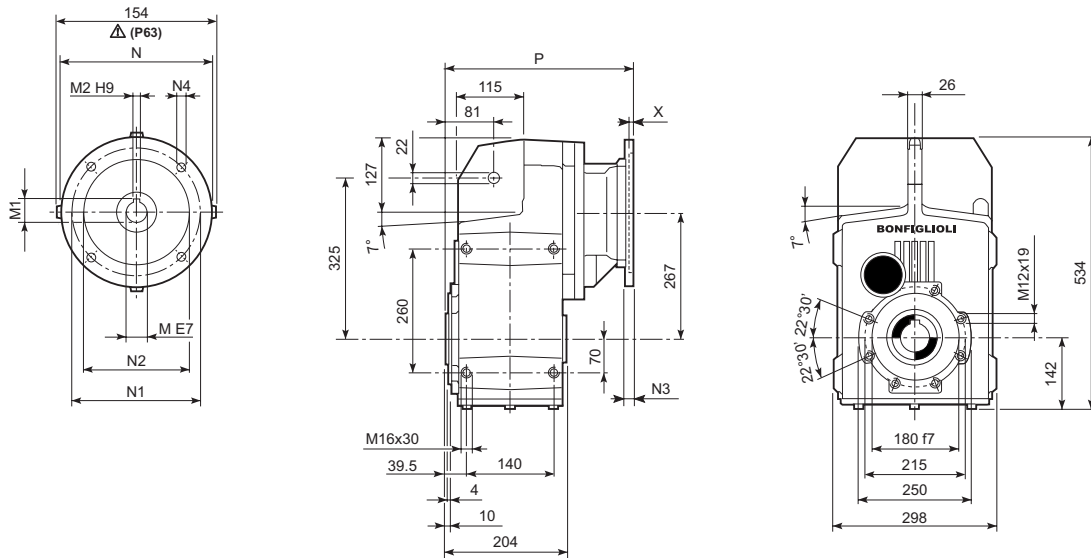
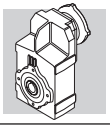

		M	M1	M2	N	N1	N2	N3	N4	X	P	
F 60 3	P63	11	12.8	4	140	115	95	—	M8x19	4	302.5	103
F 60 3	P71	14	16.3	5	160	130	110	—	M8x16	4.5	302.5	103
F 60 3	P80	19	21.8	6	200	165	130	—	M10x12	4	322	104
F 60 3	P90	24	27.3	8	200	165	130	—	M10x12	4	322	104
F 60 3	P100	28	31.3	8	250	215	180	—	M12x16	4.5	331	108
F 60 3	P112	28	31.3	8	250	215	180	—	M12x16	4.5	331	108
F 60 3	P132	38	41.3	10	300	265	230	16	14	5	367.5	111
F 60 3	P160	42	45.3	12	350	300	250	23	18	5.5	419	116
F 60 3	P180	48	51.8	14	350	300	250	23	18	5.5	419	116
F 60 4	P63	11	12.8	4	140	115	95	—	M8x19	4	373	108
F 60 4	P71	14	16.3	5	160	130	110	—	M8x16	4.5	373	108
F 60 4	P80	19	21.8	6	200	165	130	—	M10x12	4	392.5	110
F 60 4	P90	24	27.3	8	200	165	130	—	M10x12	4	392.5	110
F 60 4	P100	28	31.3	8	250	215	180	—	M12x16	4.5	402.5	114
F 60 4	P112	28	31.3	8	250	215	180	—	M12x16	4.5	402.5	114

F 60...HS

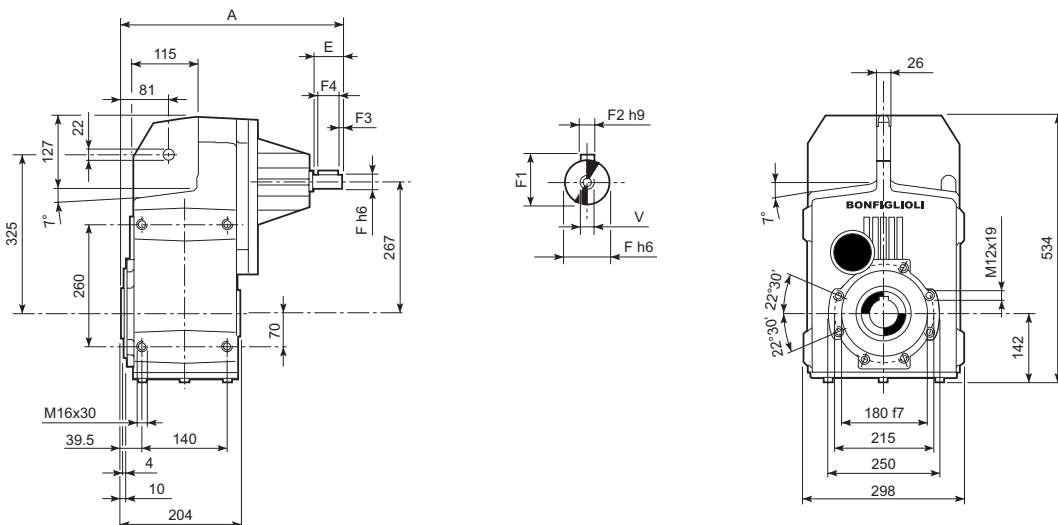

		A	E	F	F1	F2	F3	F4	V	
F 60 3	HS	419	60	28	31	8	5.0	50	M10x22	108
F 60 4		462.5	50	24	27	8	2.5	45	M8x19	105

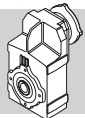

F 60...SK / SC

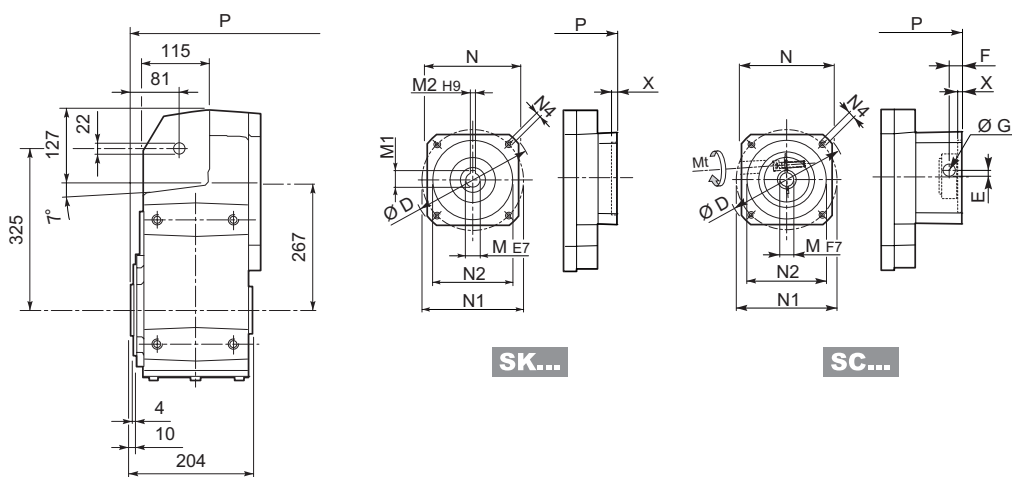

SK...

SC...

C	I	D	M	M1	M2	N	N1	N2	N4	X	3x		4x	
											P		P	
F 60 4	SK 80B	120	14	16.3	5	96	100	80	M6x12	4	—	—	392.5	109
F 60 3/4	SK 80C	120	19	21.8	6	96	100	80	M6x12	4	322	106	—	—
F 60 3/4	SK 95A	130	14	16.3	5	102	115	95	M8x12	4	322	106	392.5	112
F 60 3/4	SK 95B	130	19	21.8	6	102	115	95	M8x12	4	322	106	392.5	112
F 60 3/4	SK 95C	130	24	27.3	8	102	115	95	M8x12	4	322	106	392.5	112
F 60 3/4	SK 110A	140	19	21.8	6	120	130	110	M8x12	5	322	106	392.5	112
F 60 3/4	SK 110B	140	24	27.3	8	120	130	110	M8x12	5	322	106	392.5	112
F 60 3/4	SK 130A	188	24	27.3	8	142	165	130	M10x20	5	322	108	392.5	112
F 60 3	SK 130B	189	32	35.3	10	160	165	130	M10x20	5	368.5	109	392.5	114
F 60 3	SK 180A	240	32	35.3	10	192	215	180	M12x19	5	368.5	109	—	—
F 60 3	SK 180B	240	38	41.3	10	192	215	180	M12x19	5	368.5	109	—	—

C	I		Mt	D	E	F	G	M	N	N1	N2	N4	X	3x		4x	
														P		P	
F 60 4	SC 80B	M6	15 Nm	120	15.5	14.5	17.75	14	96	100	80	M6x12	4	—	—	416	113
F 60 3/4	SC 80C	M6	15 Nm	120	15.5	14.5	17.75	19	96	100	80	M6x12	4	345.5	107	416	113
F 60 3/4	SC 95A	M6	15 Nm	130	16.5	15	17.75	14	102	115	95	M8x16	4	345.5	107	416	113
F 60 3/4	SC 95B	M6	15 Nm	130	16.5	15	17.75	19	102	115	95	M8x16	4	345.5	107	416	113
F 60 3/4	SC 95C	M6	15 Nm	130	16.5	15	17.75	24	102	115	95	M8x16	4	345.5	107	416	113
F 60 3/4	SC 110A	M6	15 Nm	140	16.5	16	17.75	19	120	130	110	M8x16	5	345.5	108	416	113
F 60 3/4	SC 110B	M6	15 Nm	140	16.5	16	17.75	24	120	130	110	M8x16	5	345.5	108	416	113
F 60 3/4	SC 130A	M6	15 Nm	188	19	16	17.75	24	142	165	130	M10x20	5	345.5	109	416	115
F 60 3	SC 130B	M8	36 Nm	189	20	17	17.75	32	160	165	130	M10x20	5	390.5	112	—	—
F 60 3	SC 180A	M8	36 Nm	240	20	17.5	17.75	32	192	215	180	M12x24	5	394.5	112	—	—
F 60 3	SC 180B	M8	36 Nm	240	20	17.5	17.75	38	192	215	180	M12x24	5	394.5	112	—	—

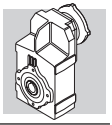

F 60...H

H60 STANDARD

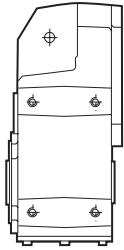
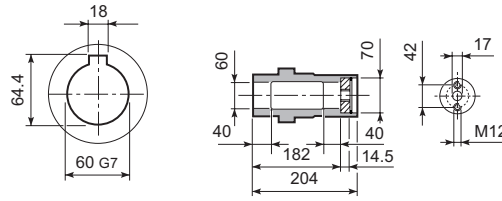

F 60...S

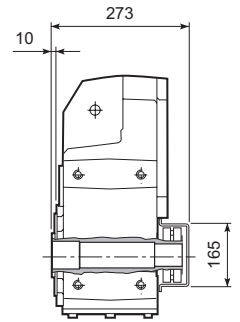
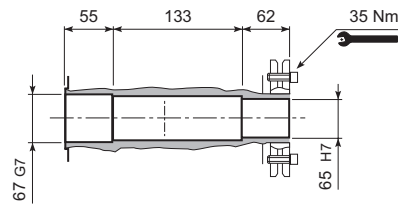

F 60...R

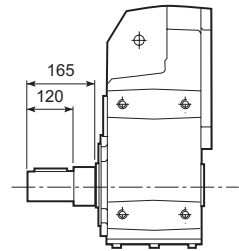
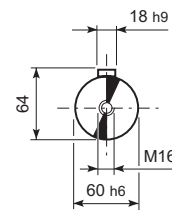

F 60...QF

	Ø
QF55	55
QF60	60
QF65	65
QF70	70

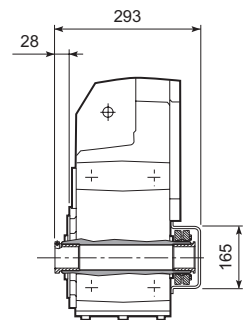
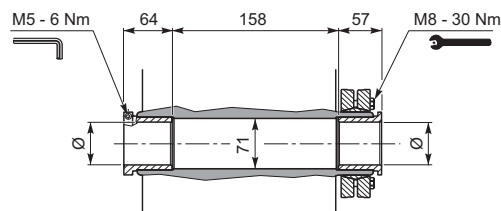

F 60...F...

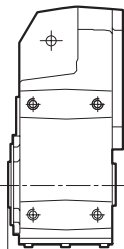
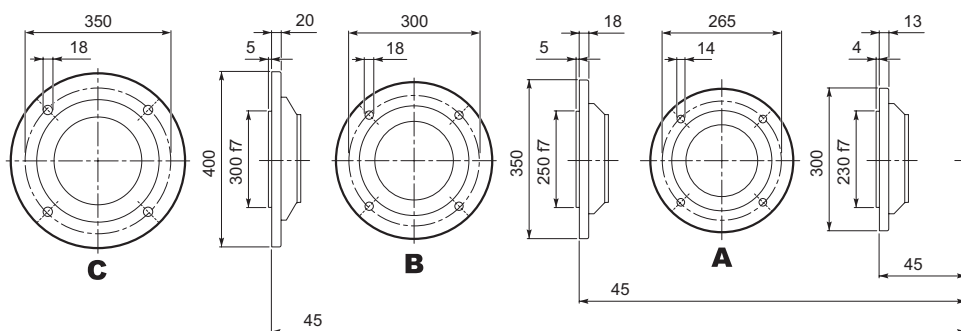

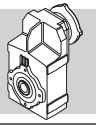

F 70...M

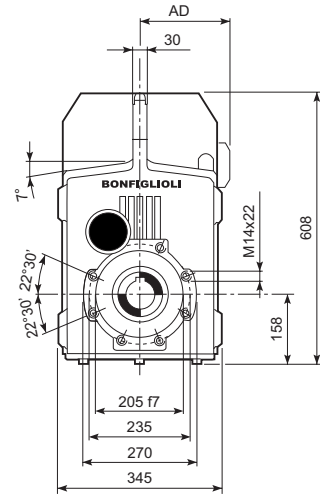
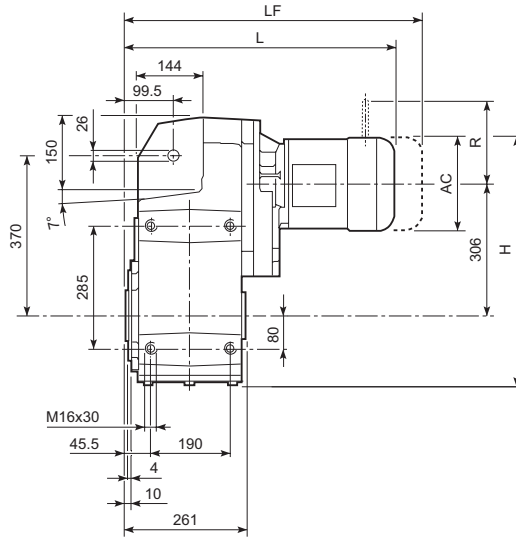

C	D	E						M_FD		M_FD		M_FA	
			AC	H	L	AD		LF		R	AD	R	AD
F 70 3	S2	M2S	156	542	552	119	173	622	177	129	143	134	119
F 70 3	S3	M3S	195	561.5	595	142	178	691	186	160	155	160	142
F 70 3	S3	M3L	195	561.5	627	142	186	718	193	160	155	160	142
F 70 3	S4	M4	258	593	735	193	220	844	238	226	193	217	193
F 70 3	S4	M4LC	258	593	770	193	228	869	246	226	193	217	193
F 70 3	S5	M5S	310	619	821.5	245	248	961.5	278	266	245	247	245
F 70 3	S5	M5L	310	619	865.5	245	264	1005.5	294	266	245	247	245
F 70 4	S1	M1S	138	533	550	108	171	613	174	103	132	124	108
F 70 4	S1	M1L	138	533	574	108	173	635	176	103	132	124	108
F 70 4	S2	M2S	156	542	603	119	177	673	180	129	143	134	119
F 70 4	S3	M3S	195	561.5	646	142	181	742	189	160	155	160	142
F 70 4	S3	M3L	195	561.5	678	142	189	769	196	160	155	160	142
F 70 4	S4	M4	258	593	786	193	223	895	241	226	193	217	193
F 70 4	S4	M4LC	258	593	821	193	231	920	249	226	193	217	193

F 70...P(IEC)

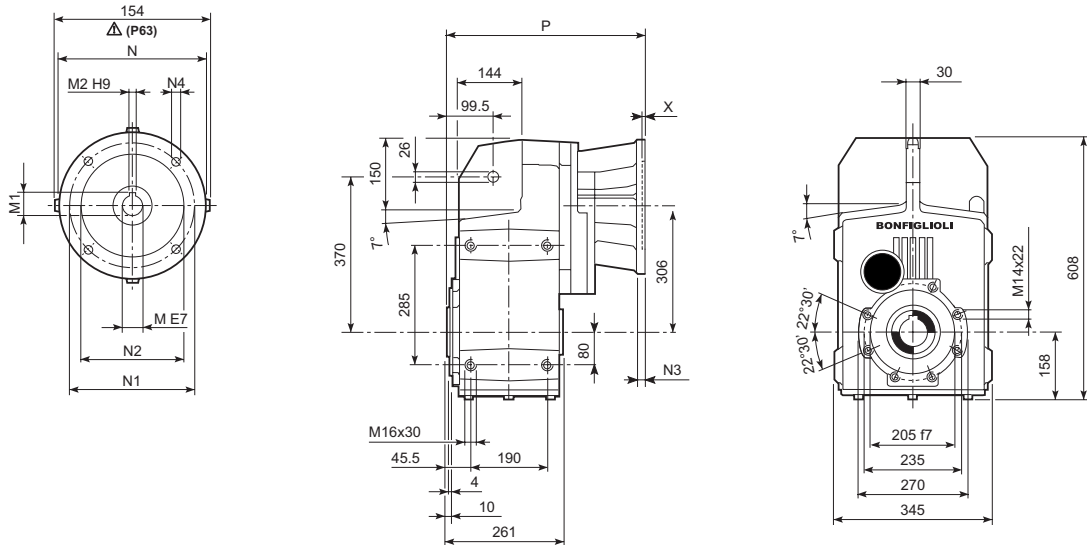
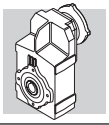

		M	M1	M2	N	N1	N2	N3	N4	X	P	
F 70 3	P80	19	21.8	6	200	165	130	—	M10x12	4	387.5	167
F 70 3	P90	24	27.3	8	200	165	130	—	M10x12	4	387.5	167
F 70 3	P100	28	31.3	8	250	215	180	—	M12x16	4.5	397.5	171
F 70 3	P112	28	31.3	8	250	215	180	—	M12x16	4.5	397.5	171
F 70 3	P132	38	41.3	10	300	265	230	16	14	5	434	173
F 70 3	P160	42	45.3	12	350	300	250	23	18	6	489.5	185
F 70 3	P180	48	51.8	14	350	300	250	23	18	6	489.5	185
F 70 3	P200	55	59.3	16	400	350	300	—	M16x25	7	514.5	206
F 70 4	P63	11	12.8	4	140	115	95	—	M8x19	4	419	168
F 70 4	P71	14	16.3	5	160	130	110	—	M8x16	4.5	419	168
F 70 4	P80	19	21.8	6	200	165	130	—	M10x12	4	438.5	170
F 70 4	P90	24	27.3	8	200	165	130	—	M10x12	4	438.5	170
F 70 4	P100	28	31.3	8	250	215	180	—	M12x16	4.5	446.5	174
F 70 4	P112	28	31.3	8	250	215	180	—	M12x16	4.5	446.5	174
F 70 4	P132	38	41.3	10	300	265	230	16	14	5	482	176

F 70...HS

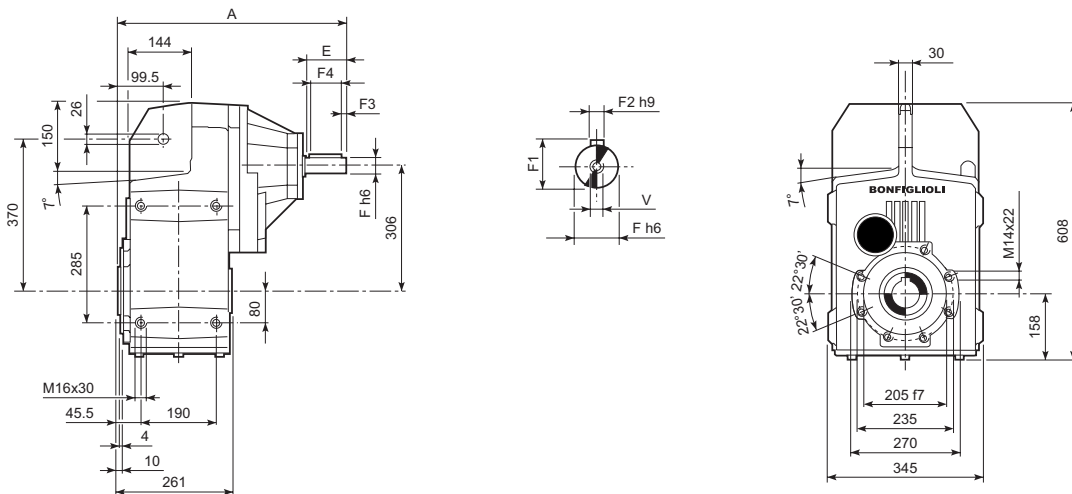

		A	E	F	F1	F2	F3	F4	V	
F 70 3	HS	572	110	42	45	12	10	90	M12x28	186
F 70 4		508.5	50	24	27	8	2.5	45	M8x19	174

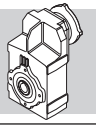

F 70

F 70...H

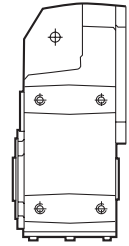
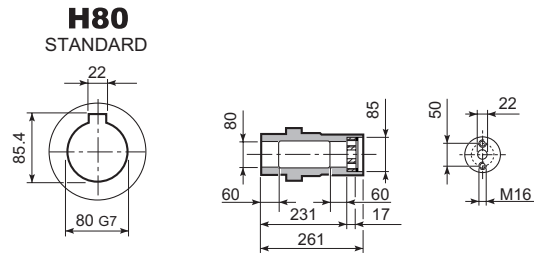

F 70...S

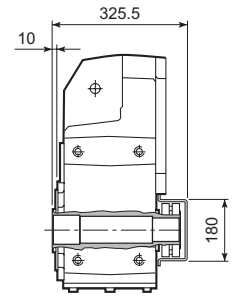
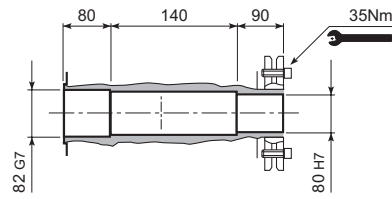

F 70...R

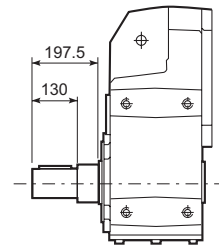
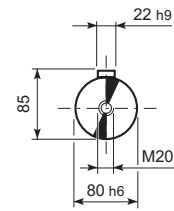

F 70...F...

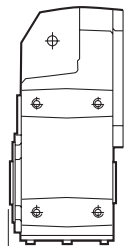
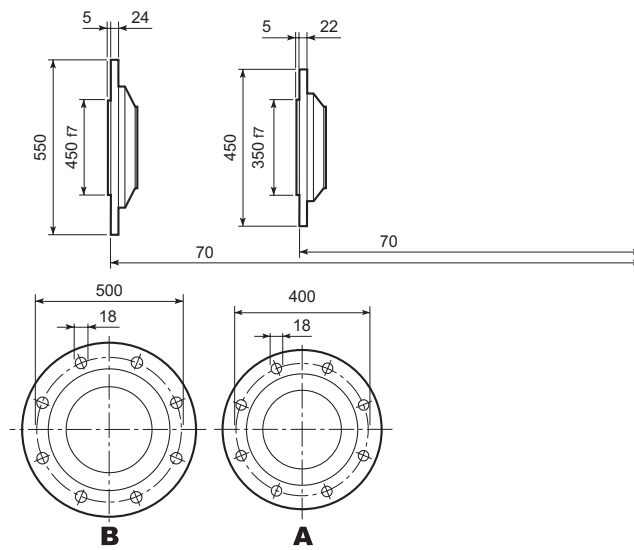

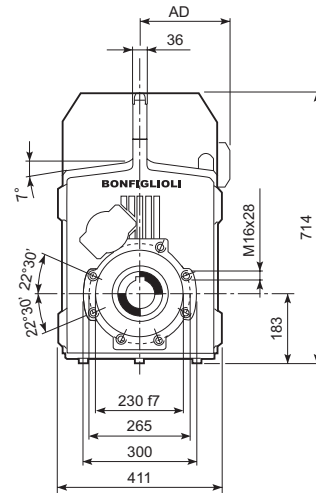
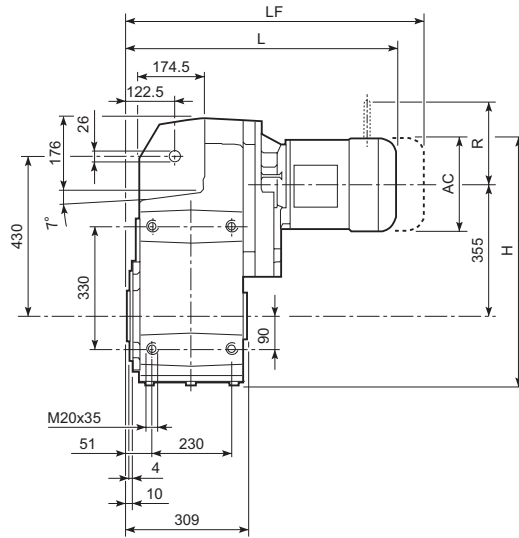
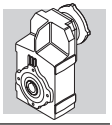

									M_FD M_FA		M_FD		M_FA	
			AC	H	L	AD		LF		R	AD	R	AD	
F 80 3	S4	M4	258	667	793	193	307	902	325	226	193	217	193	
F 80 3	S4	M4LC	258	667	828	193	315	927	333	226	193	217	193	
F 80 3	S5	M5S	310	693	879.5	245	335	1019.5	365	266	245	247	245	
F 80 3	S5	M5L	310	693	923.5	245	351	1063.5	381	266	245	247	245	
F 80 4	S1	M1S	138	607	620	108	261	683	263	103	132	124	108	
F 80 4	S1	M1L	138	607	644	108	262	705	265	103	132	124	108	
F 80 4	S2	M2S	156	616	673	119	266	743	269	129	143	134	119	
F 80 4	S3	M3S	195	635.5	716	142	271	812	278	160	155	160	142	
F 80 4	S3	M3L	195	635.5	748	142	278	839	285	160	155	160	142	
F 80 4	S4	M4	258	667	856	193	312	965	330	226	193	217	193	
F 80 4	S4	M4LC	258	667	891	193	320	990	338	226	193	217	193	

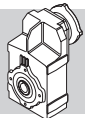

F 80...P(IEC)

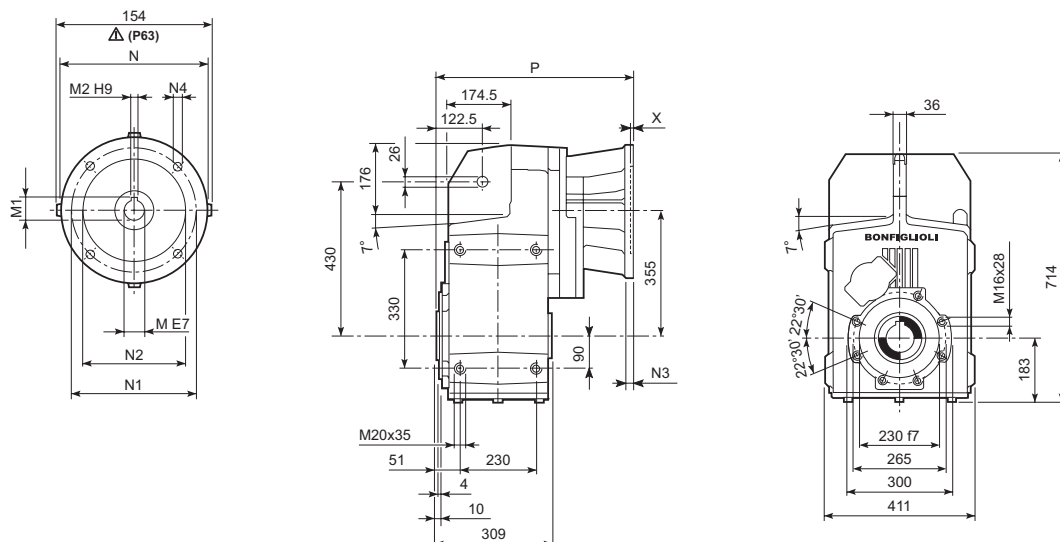

		M	M1	M2	N	N1	N2	N3	N4	X	P	
F 80 3	P80	19	21.8	6	200	165	130	—	M10x12	4	445.5	255
F 80 3	P90	24	27.3	8	200	165	130	—	M10x12	4	445.5	255
F 80 3	P100	28	31.3	8	250	215	180	—	M12x16	4.5	455.5	259
F 80 3	P112	28	31.3	8	250	215	180	—	M12x16	4.5	455.5	259
F 80 3	P132	38	41.3	10	300	265	230	16	14	5	492	261
F 80 3	P160	42	45.3	12	350	300	250	23	18	6	547.5	276
F 80 3	P180	48	51.8	14	350	300	250	23	18	6	547.5	276
F 80 3	P200	55	59.3	16	400	350	300	—	M16x25	7	572.5	298
F 80 3	P225	60	64.4	18	450	400	350	25	18	6	618	298
F 80 4	P63	11	12.8	4	140	115	95	—	M8x19	4	489	258
F 80 4	P71	14	16.3	5	160	130	110	—	M8x16	4.5	489	258
F 80 4	P80	19	21.8	6	200	165	130	—	M10x12	4	508.5	260
F 80 4	P90	24	27.3	8	200	165	130	—	M10x12	4	508.5	260
F 80 4	P100	28	31.3	8	250	215	180	—	M12x16	4.5	518.5	264
F 80 4	P112	28	31.3	8	250	215	180	—	M12x16	4.5	518.5	264
F 80 4	P132	38	41.3	10	300	265	230	16	M12x16	5	552	266

F 80...HS

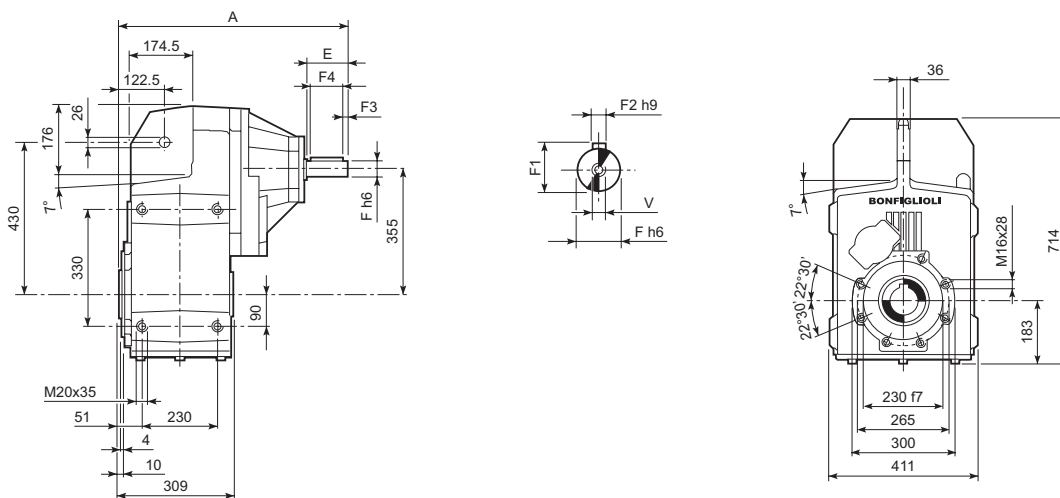

		A	E	F	F1	F2	F3	F4	V	
F 80 3	HS	630	110	42	45	12	10	90	M12x28	273
F 80 4		575.5	50	24	27	8	2.5	45	M8x19	263

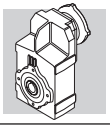

F 80...H

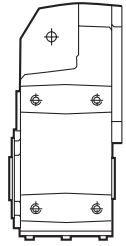
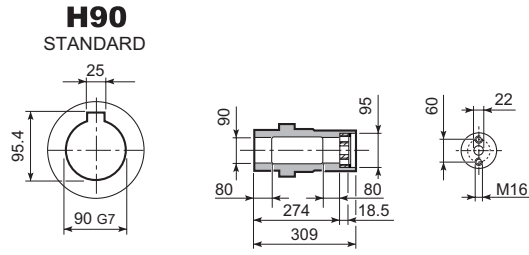

F 80...S

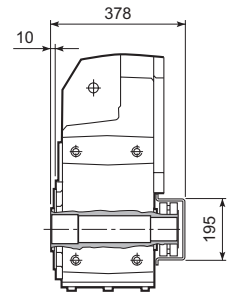
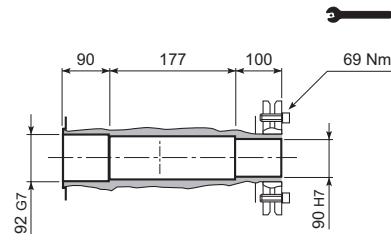

F 80...R

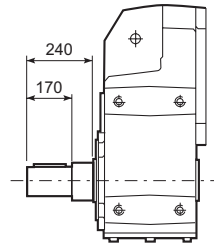
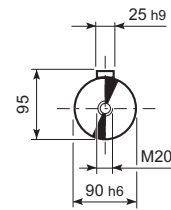

F 80...F...

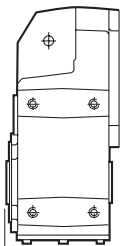
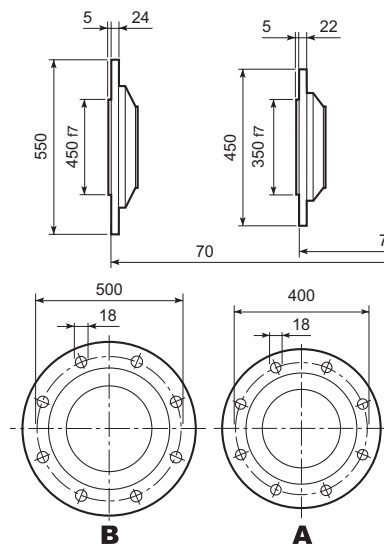

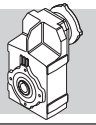

F 90...M

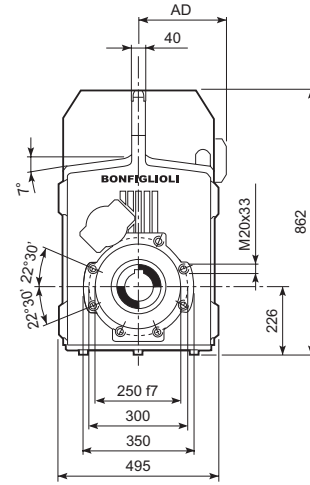
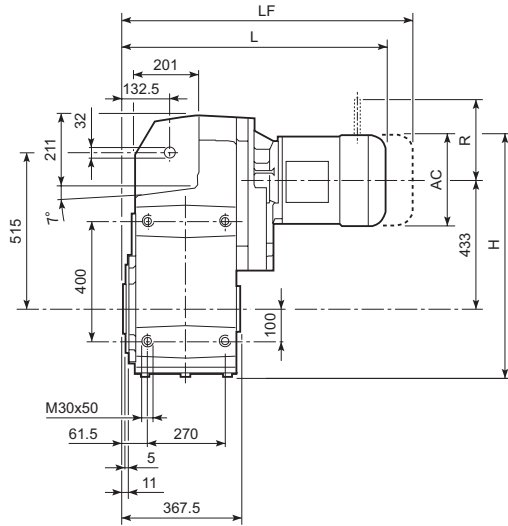

C	D	E	AC	H	L	AD	Kg	M_FD M_FA		M_FD		M_FA	
								LF	Kg	R	AD	R	AD
F 90 3	S3	M3S	195	756	728	142	453	824	460	160	155	160	142
F 90 3	S3	M3L	195	756	760	142	460	851	467	160	155	160	142
F 90 3	S4	M4	258	787.5	868	193	494	977	512	226	193	217	193
F 90 3	S5	M5L	310	813.5	998.5	245	538	1138.5	568	266	245	247	245
F 90 4	S2	M2S	156	736.5	768	119	456	838	460	129	143	134	119
F 90 4	S3	M3S	195	756	811	142	460	907	468	160	155	160	142
F 90 4	S3	M3L	195	756	843	142	468	934	475	160	155	160	142
F 90 4	S4	M4	258	787.5	951	193	502	1060	520	226	193	217	193
F 90 4	S4	M4LC	258	787.5	986	193	510	1085	528	226	193	217	193

F 90...P(IEC)

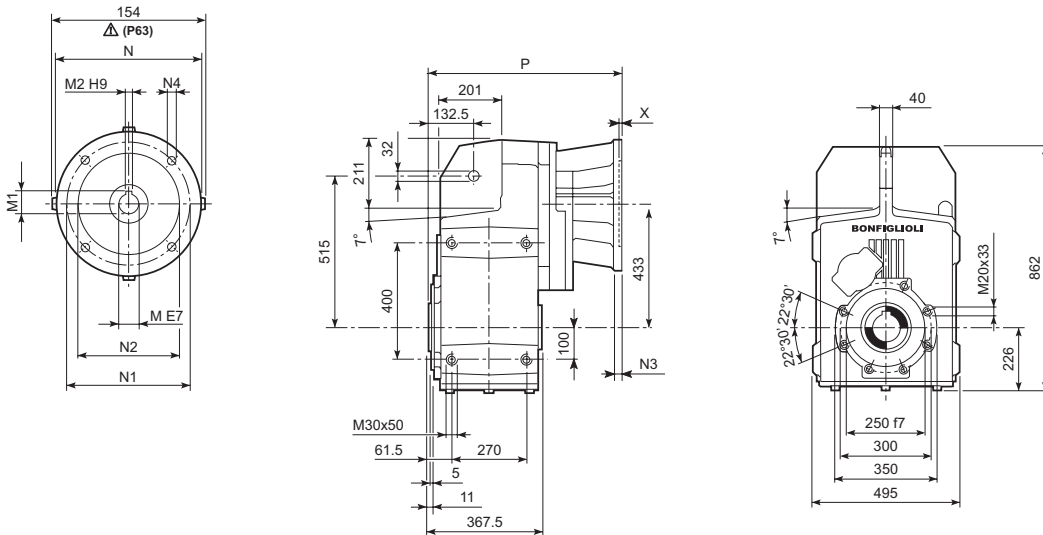
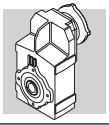

		M	M1	M2	N	N1	N2	N3	N4	X	P	
F 90 3	P80	19	21.8	6	200	165	130	—	M10x12	4	520.5	442
F 90 3	P90	24	27.3	8	200	165	130	—	M10x12	4	520.5	442
F 90 3	P100	28	31.3	8	250	215	180	—	M12x16	4.5	530.5	446
F 90 3	P112	28	31.3	8	250	215	180	—	M12x16	4.5	530.5	446
F 90 3	P132	38	41.3	10	300	265	230	16	14	5	567	449
F 90 3	P160	42	45.3	12	350	300	250	23	18	6	622.5	463
F 90 3	P180	48	51.8	14	350	300	250	23	18	6	622.5	463
F 90 3	P200	55	59.3	16	400	350	300	—	M16x25	7	647.5	485
F 90 3	P225	60	64.4	18	450	400	350	30	18	6	693	485
F 90 3	P250	65	69.4	18	550	500	450	30	18	6	723	507
F 90 4	P63	11	12.8	4	140	115	95	—	M8x19	4	584	448
F 90 4	P71	14	16.3	5	160	130	110	—	M8x16	4.5	584	448
F 90 4	P80	19	21.8	6	200	165	130	—	M10x12	4	603.5	450
F 90 4	P90	24	27.3	8	200	165	130	—	M10x12	4	603.5	450
F 90 4	P100	28	31.3	8	250	215	180	—	M12x16	4.5	613.5	454
F 90 4	P112	28	31.3	8	250	215	180	—	M12x16	4.5	613.5	454
F 90 4	P132	38	41.3	10	300	265	230	16	14	5	650	455
F 90 4	P160	42	45.3	12	350	300	250	23	18	5.5	700.5	461
F 90 4	P180	48	51.8	14	350	300	250	23	18	5.5	700.5	461

F 90...HS

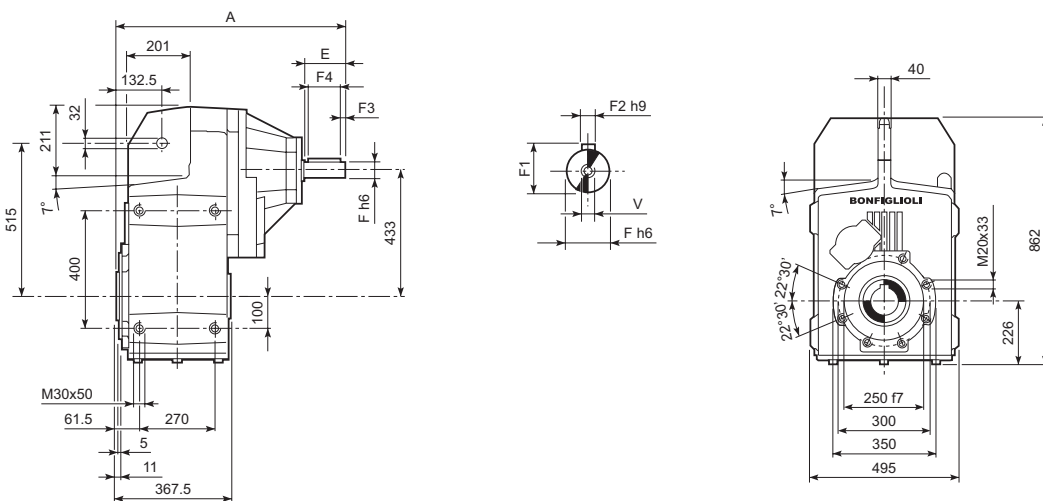

		A	E	F	F1	F2	F3	F4	V	
F 90 3	HS	806.5	140	60	64	18	10	120	M16x36	485
F 90 4		673.5	50	24	27	8	2.5	45	M8x19	452

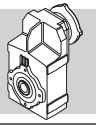

F 90

F 90...H

H100 STANDARD

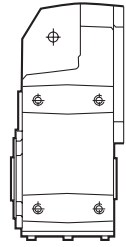
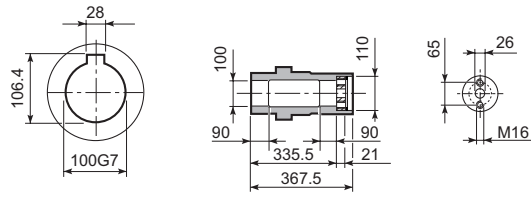

F 90...S

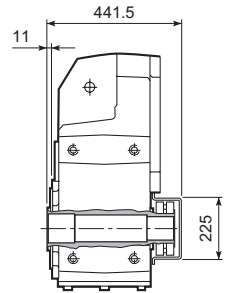
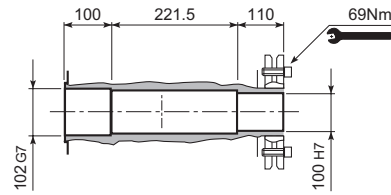

F 90...R

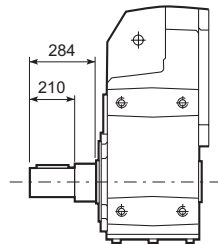
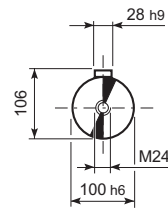

F 90...F...

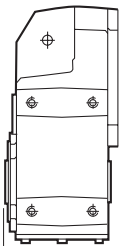
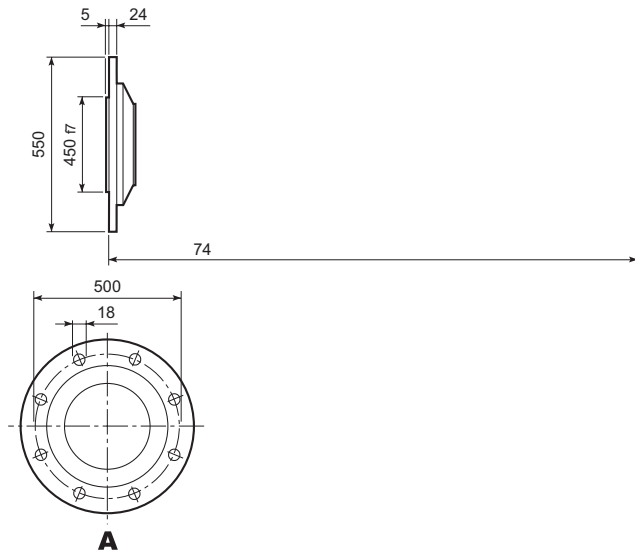

A

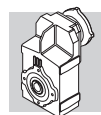

33 – ДОПОЛНИТЕЛЬНОЕ ОБОРУДОВАНИЕ

Набор деталей демпфера гашения вибраций

По специальным заказам редукторы серии F могут быть укомплектованы набором деталей демпфера гашения вибраций. В набор входят все детали, необходимые для установки редуктора, монтируемого на вал (кроме моментного рычага). Размеры деталей указаны в таблице (B20).

(B20)

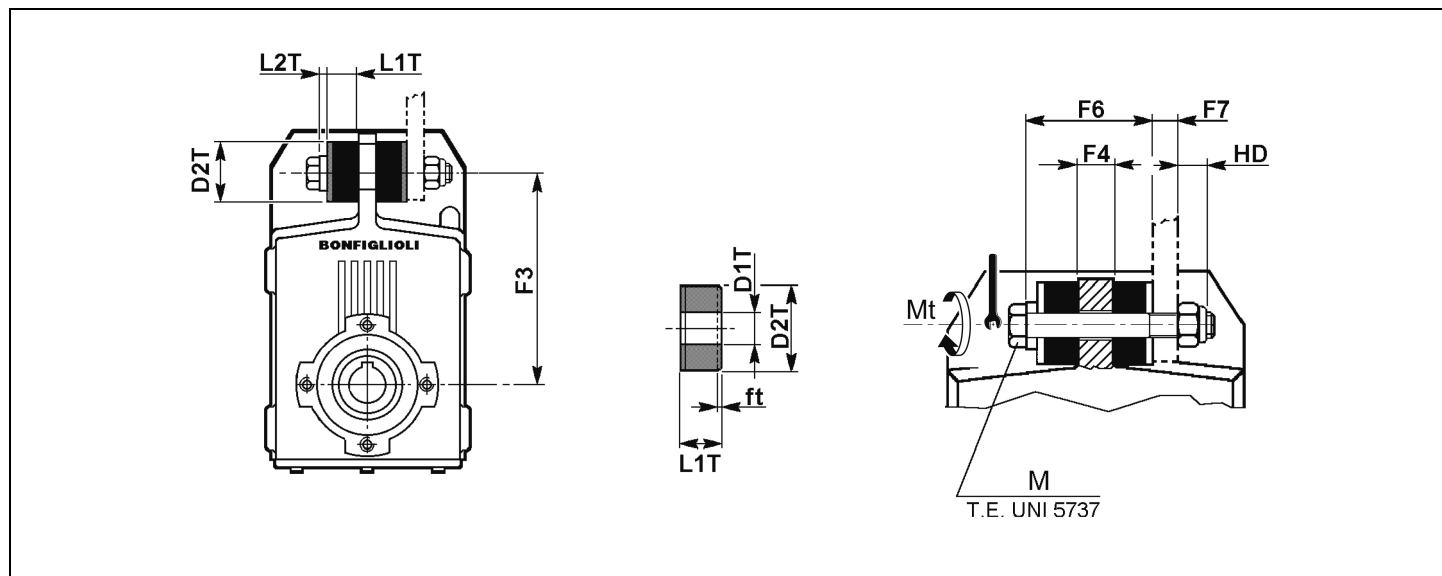

	F3	F4	F6	F7 (max.)	HD	L1T	L2T	D1T	D2T	M	Mt [Nm]	ft
F 10	140	20	55	10	12.3	15	5	11	30	M10x80	10	1.5
F 20	160	20	55	10	12.3	15	5	11	30	M10x80	10	1.5
F 25	162	20	65	20	14.8	20	5	12.5	40	M12x100	20	1.5
F 31	170	20	65	20	14.8	20	5	12.5	40	M12x100	20	1.5
F 41	218	16	61	24	14.8	20	5	12.5	40	M12x100	20	2.3
F 51	278	20	90	47	23	30	10	21	60	M20x160	50	3.0
F 60	325	26	96	41	23	30	10	21	60	M20x160	50	4.0
F 70	370	30	122	50	28	40	12	25	80	M24x200	100	4.0
F 80	430	36	128	44	28	40	12	25	80	M24x200	100	6.0
F 90	515	40	175	40	33.2	60	15	32	100	M30x260	200	9.0

ft= укорочение резиновой втулки при применении номинального крутящего момента.

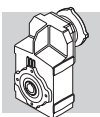

Фланцы

На выход редуктора пользователем может быть установлен фланец. В ассортименте имеются фланцы трех различных конфигураций (А,В,С) и размеров.

Фланцы поставляются в качестве дополнительного оборудования.

Размеры фланцев для каждого типоразмера редукторов приведены в таблице (В21).

(В21)

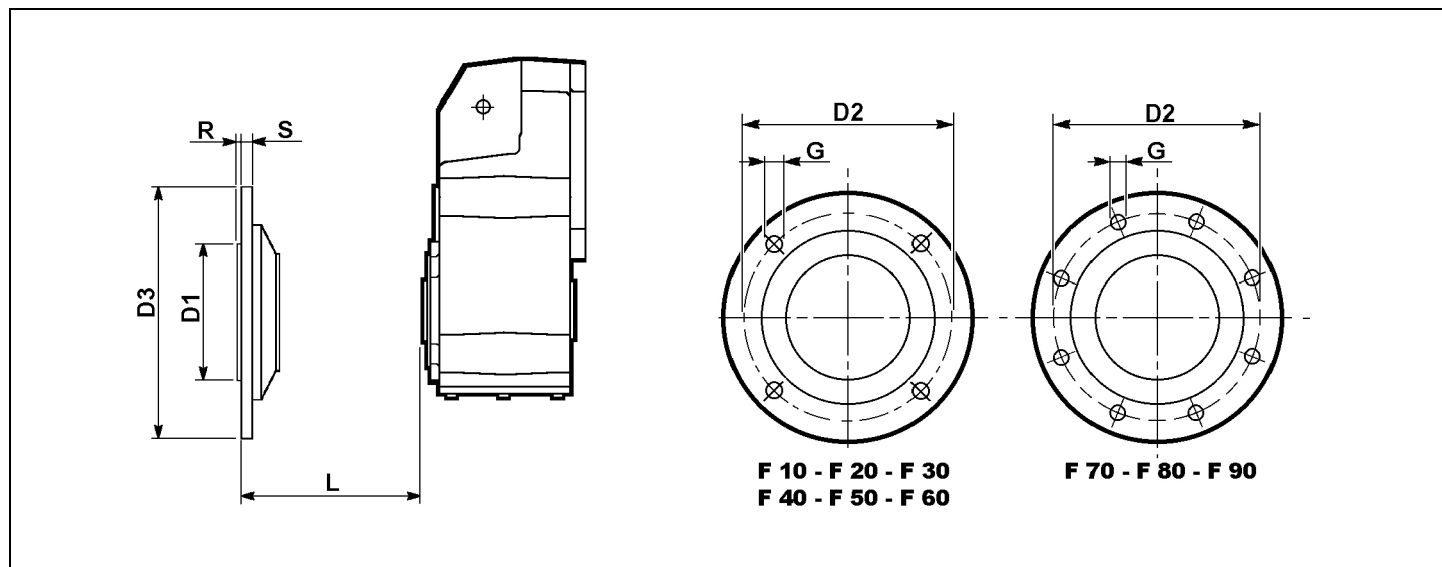

		D1 f7	D2	D3	G	R	S	L
F 10	FA	110	130	160	9	3	10	31.5
	FB	130	165	200	11	3.5	11	31.5
	FC	180	215	250	14	4	13	31.5
F 20	FA	110	130	160	9	3	10	36
	FB	130	165	200	11	3.5	11	36
	FC	180	215	250	14	4	13	36
F 25	FA	130	165	200	11	3.5	11	33
	FB	180	215	250	14	4	13	33.5
F 31	FA	180	215	250	14	4	13	33
	FB	230	265	300	14	4	16	33
F 41	FA	180	215	250	14	4	13	32.5
	FB	230	265	300	14	4	16	32.5
	FC	250	300	350	18	5	18	32.5
F 51	FA	230	265	300	14	4	13	46.5
	FB	250	300	350	18	5	18	46.5
	FC	300	350	400	18	5	20	46.5
F 60	FA	230	265	300	14	4	13	45
	FB	250	300	350	18	5	18	45
	FC	300	350	400	18	5	20	45
F 70	FA	350	400	450	18	5	22	67.5
	FB	450	500	550	18	5	24	67.5
F 80	FA	350	400	450	18	5	22	70
	FB	450	500	550	18	5	24	70
F 90	FA	450	500	550	18	5	24	74

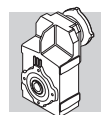

Удлинитель выходного вала

В таблице (B22) приведены размеры удлинителей выходного вала, поставляемых в качестве дополнительного оборудования для редукторов серии F.

(B22)

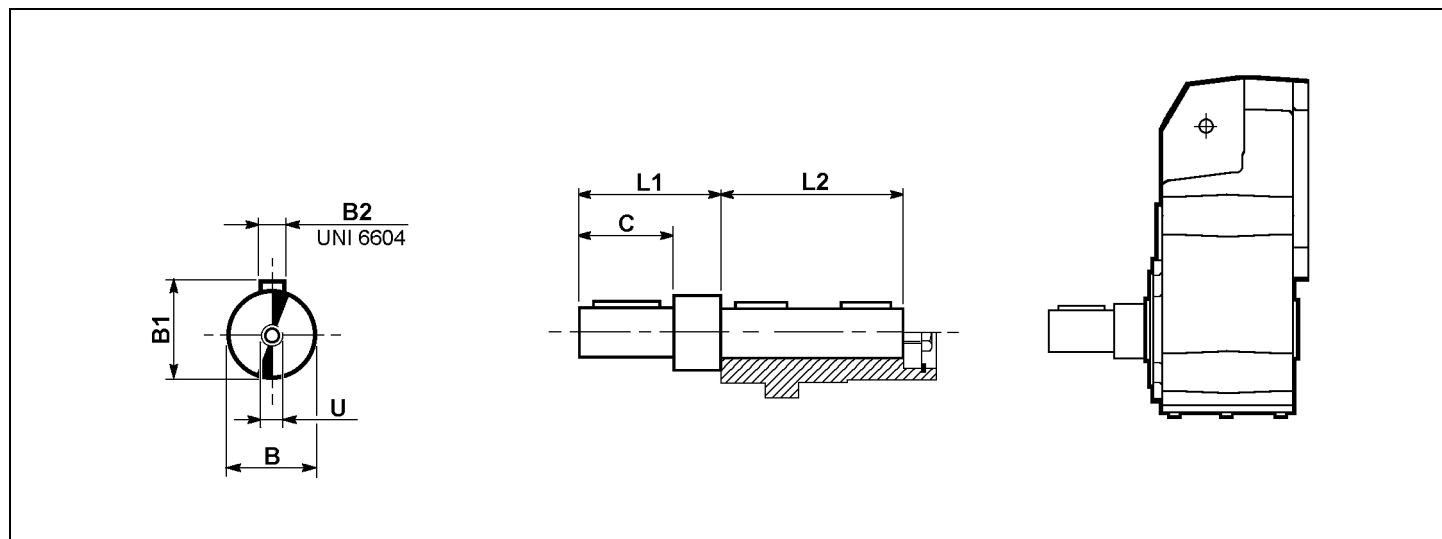

	B h6	B1	B2	C	L1	L2	U
F 10	25	28	8	45	76.5	87.5	M8
F 20	30	33	8	60	96	100	M10
F 25	35	38	10	60	93	104	M10
F 31	35	38	10	60	93	104	M10
F 41	40	43	12	80	112.5	118.5	M12
F 51	50	53.5	14	100	146.5	139.5	M16
F 60	60	64	18	120	165	180	M16
F 70	80	85	22	130	197.5	229.5	M20
F 80	90	95	25	170	240	272	M20
F 90	100	106	28	210	284	333	M24

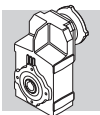

34 – ВАЛ ПРИВОДИМОГО МЕХАНИЗМА

Указания по изготовлению

Хвостовик вала приводимого механизма должен быть изготовлен из высококачественной легированной стали. В таблице ниже приведены размеры, на которые следует ориентироваться при изготовлении или выборе вала для приводимого механизма. Рекомендуется также применение устройства, обеспечивающего осевую фиксацию вала (на рисунке не показано). Количество и размеры резьбовых отверстий на торце вала выбираются в соответствии с потребностями приводимого механизма.

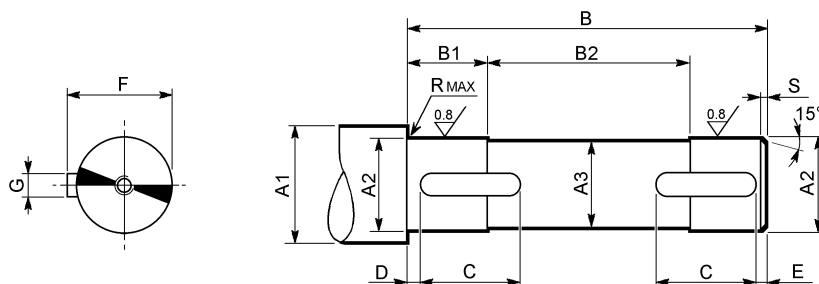
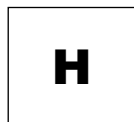

	A1	A2	A3	B	B1	B2	C	D	E	F	G	R	S	UNI 6604
F 10	≥ 35	30 h7	29	79	15.5	48	20	2	2	33	8 h9	0.5	1.5	8x7x20A
	≥ 30	25 h7	24	79	15.5	48	20	2	2	28	8 h9	0.5	1.5	8x7x20 A
F 20	≥ 42	35 h7	34	99	18	63	22	2	2	38	10 h9	0.5	1.5	10x8x22 A
	≥ 35	30 h7	29	99	18	63	22	2	2	33	8 h9	0.5	1.5	8x7x22 A
F 25	≥ 47	40 h7	39	104	23	58	30	2	2	43	12 h9	0.5	1.5	12x8x30 A
	≥ 42	35 h7	34	104	23	58	30	2	2	38	10 h9	0.5	1.5	10x8x30 A
F 31	≥ 47	40 h7	39	104	28	48	30	2	2	43	12 h9	0.5	1.5	12x8x30 A
	≥ 42	35 h7	34	104	28	48	30	2	2	38	10 h9	0.5	1.5	10x8x30 A
F 41	≥ 52	45 h7	44	118	27.5	63	45	2.5	2.5	49.5	14 h9	1	2.0	14x9x45 A
	≥ 47	40 h7	39	118	27.5	63	45	2.5	2.5	43	12 h9	1	2.0	12x8x45 A
F 51	≥ 63	55 h7	54	139	33	73	50	2.5	2.5	59	16 h9	1	2.0	16x10x50 A
	≥ 57	50 h7	49	139	33	73	50	2.5	2.5	53.5	14 h9	1	2.0	14x9x50 A
F 60	≥ 78	70 h7	69	180	38	104	70	2.5	2.5	74.5	20 h9	1	2.0	20x12x70 A
	≥ 68	60 h7	59	180	38	104	70	2.5	2.5	64	18 h9	1	2.0	18x11x70 A
F 70	≥ 89	80 h7	79	229	58	113	75	3	3	85	22 h9	2.5	2.5	22x14x75 A
	≥ 78	70 h7	69	229	58	113	75	3	3	74.5	20 h9	2.5	2.5	20x12x75 A
F 80	≥ 99	90 h7	89	272	78	116	100	3	3	95	25 h9	2.5	2.5	25x14x100 A
	≥ 89	80 h7	79	272	78	116	100	3	3	85	22 h9	2.5	2.5	22x14x100 A
F 90	≥ 111	100 h7	99 89	333	87.5	158	110	3	3	106	28 h9	2.5	2.5	28x16x110 A
	≥ 99	90 h7		333	87.5	158	110	3	3	95	25 h9	2.5	2.5	25x14x110 A

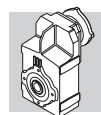

S

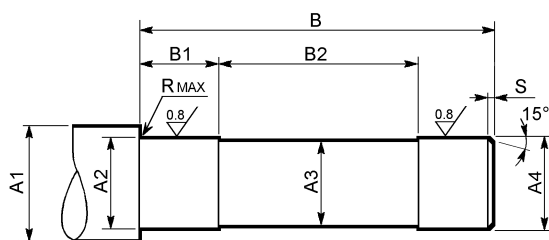

	A1	A2	A3	A4	B	B1	B2	R	S
F 10	≥ 36	27 h7	24	25 h6	138	34	70	0.5	1.5
F 20	≥ 42	32 h7	29	30 h6	160	38	84	0.5	1.5
F 25	≥ 42	32 h7	30	31 h6	172	38	96	0.5	1.5
F 31	≥ 50	38 h7	35	36 h6	155	40	73	1	2
F 41	≥ 58	44 h7	41	42 h6	177	46.5	82	1	2
F 51	≥ 68	54 h7	51	52 g6	201	48	91	1	2
F 60	≥ 84	67 h7	64	65 g6	248	53	133	1.5	2
F 70	≥ 104	82 h7	79	80 g6	308	78	140	2.5	2.5
F 80	≥ 114	92 h7	89	90 g6	365	88	177	2.5	2.5
F 90	≥ 126	102 h7	99	100 g6	429.5	98	221.5	2.5	2.5

QF

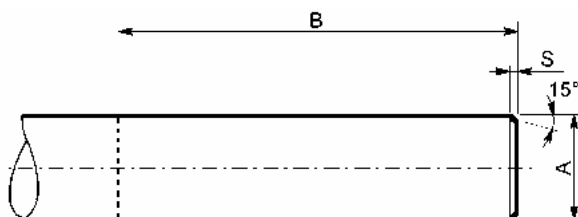

		A	B	S
F 10	QF25	25 h 11	≥ 172	1.5
	QF30	30 h 11		
F 20	QF25	25 h 11	≥ 193.5	1.5
	QF30	30 h 11		
F 25	QF30	30 h 11	≥ 209.5	1.5
	QF32	32 h 11		
F 31	QF35	35 h 11	≥ 192.5	1.5
	QF40	40 h 11		
F 41	QF42	42 h 11	≥ 211.5	2
	QF45	45 h 11		
F 51	QF50	50 h 11	≥ 233.5	2
	QF55	55 h 11		
F 60	QF55	55 h 11	≥ 279	2.5
	QF60	60 h 11		
	QF65	65 h 11		
	QF70	70 h 11		

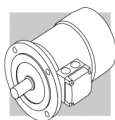

ЭЛЕКТРОДВИГАТЕЛИ

M1 - СИМВОЛЫ И ЕДИНИЦЫ ИЗМЕРЕНИЯ

Символ	Ед. Изм.	Описание
$\cos\varphi$	–	Коэффициент мощности
η	–	Коэффициент полезного действия, КПД
f_m	–	Коэффициент регулирования мощности
I	–	Продолжительность включения (относительная)
I_N	[А]	Номинальная сила тока
I_s	[А]	Ток на заторможенном роторе
J_c	[Кгм ²]	Момент инерции нагрузки
J_M	[Кгм ²]	Момент инерции
K_c	–	Коэффициент крутящего момента
K_d	–	Коэффициент нагрузки
K_J	–	Коэффициент инерции
M_A	[Нм]	Средний пусковой момент
M_B	[Нм]	Тормозной момент
M_N	[Нм]	Номинальный крутящий момент
M_L	[Нм]	Обратный крутящий момент во время ускорения
M_S	[Нм]	Пусковой крутящий момент
n	[мин ⁻¹]	Номинальная скорость вращения
P_B	[Вт]	Мощность, потребляемая тормозом при 20°C
P_n	[кВт]	Номинальная мощность двигателя
P_r	[кВт]	Потребляемая мощность
t_1	[мс]	Время срабатывания тормоза с однополупериодным выпрямителем
t_{1s}	[мс]	Время срабатывания тормоза с выпрямителем с электронным управлением
t_2	[мс]	Время срабатывания тормоза с размыканием постоянного тока
t_{2c}	[мс]	Время срабатывания тормоза с размыканием переменного и постоянного тока
t_a	[°C]	Температура окружающей среды
t_f	[мин]	Время работы при постоянной нагрузке
t_r	[мин]	Время покоя
B	[J]	Работа тормоза между мероприятиями по регулировке и обслуживанию
W_{max}	[J]	Максимальная работа тормоза на одно торможение
Z	[1/ч]	Допустимая частота пусков с нагрузкой
Z_0	[1/ч]	Максимальная допустимая частота пусков без нагрузки ($I = 50\%$)

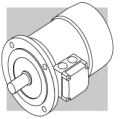

M2 - ОБЩАЯ ХАРАКТЕРИСТИКА

Ассортимент продукции

В настоящем каталоге приводятся технические описания трехфазных асинхронных электродвигателей низкого напряжения производства компании BONFIGLIOLI RIDUTTORI.

Электродвигатели в закрытом исполнении с внешним вентилятором и короткозамкнутым ротором, предназначены для промышленного применения.

Применяемые стандарты

Электродвигатели изготавливаются в соответствии со стандартами CEI/EN и IEC, указанными в таблице:

(A26)

Наименование стандарта	CEI	IEC
Общие требования к вращающимся электрическим машинам	CEI EN 60034-1	IEC 60034-1
Маркировка выводов и направление вращения вращающихся машин	CEI 2-8	IEC 60034-8
Методы охлаждения электрических машин	CEI EN 60034-6	IEC 60034-6
Размеры и выходные характеристики вращающихся машин	EN 50347	IEC 60072
Классификация степеней защиты, обеспечиваемой корпусами вращающихся	CEI EN 60034-9	IEC 60034-9
Уровни шума	CEI EN 60034-5	IEC 60034-5
Классификация типов конструкции и схем расположения узлов	CEI EN 60034-9	IEC 60034-9
Номинальное напряжение сети электропитания низкого напряжения	CEI EN 60034-7	IEC 60034-7
Уровень вибрации электрических машин	CEI 8-6	IEC 60038

Электродвигатели также отвечают требованиям национальных стандартов, приведенных ниже:

(A27)

DIN VDE 0530	Германия
BS5000 / BS4999	Великобритания
AS1359	Австралия
NBNC 51 -101	Бельгия
NEK -IEC 34	Норвегия
NF C 51	Франция
OEVE M 10	Австрия
SEV 3009	Швейцария
NEN 3173	Нидерланды
SS 426 01 01	Швеция

CUS

ДВИГАТЕЛИ ДЛЯ США И КАНАДЫ

Двигатели BN и M доступны в варианте исполнения NEMA C (по электрическим свойствам), сертифицированные CSA (Канадский стандарт) C22.2 No. 100 и UL (Underwriters Laboratory) UL 1004. При наличии опции CUS шильда мотора маркируется следующими символами:



Сетевое напряжение США и соответствующее номинальное напряжение приведены в следующей таблице:

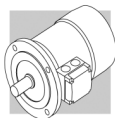

(A28)

Частота	Сетевое напряжение	Напряжение электродвигателя
60 Гц	208 В	200 В
	240 В	230 В
	480 В	460 В
	600 В	575 В

Моторы с соединением YY/Y (напр. 230/460-60; 220/440-60) в стандартном исполнении оснащены 9-контактной распределительной коробкой. В некоторых исполнениях, также как и при питании 575V-60Гц, номинальный режим совпадает с режимом 50Гц.

Для двигателей тормозов постоянного тока типа BN_FD, выпрямитель подключается к однофазному источнику питания 230 В переменного тока распределительной коробки электродвигателя.

Источник питания тормозов для моторов тормозов следующий:

BN_FD M_FD	BN_FA ; BN_BA M_FA	Specify
Подключение к распределительной коробке 1~230В переменного тока	Отдельный источник питания 230В Δ -60Гц	230SA
	Отдельный источник питания 460В Y -60Гц	460SA

Опция CUS неприменима к двигателям с сервоventilацией.

директивы европейского союза 73/23/ ЕЕС (Об электрических системах низкого напряжения) и 89/336/ ЕЕС (об электромагнитной совместимости)

Электродвигатели BN изготавливаются в соответствии с требованиями Директив Европейского Союза 73/23/ЕЕС (об электрических системах низкого напряжения – Low Voltage Directive, LVD) и 89/336/ ЕЕС (об электромагнитной совместимости – Electromagnetic Compatibility Directive, EMC), что подтверждается маркировкой «CE» на заводских идентификационных шильдах электродвигателей.

Согласно Директиве EMC, конструкция двигателей отвечает требованиям стандартов CEI EN 60034-1 разд.12, EN 50081, EN 50082. Электродвигатели, оснащенные тормозом FD, при наличии соответствующего емкостного фильтра на входе выпрямителя (модификация CF), соответствуют требованиям по предельному излучению согласно стандарту EN 50081-1 «Электромагнитная совместимость – Стандарт по общему излучению – Часть 1: Среда жилищной, коммерческой застройки и промышленных сооружений легкой промышленности» (“Electromagnetic compatibility - Generic Emission Standard - Part 1: Residential, commercial and light industrial environment”).

Электродвигатели также отвечают требованиям стандарта CEI EN 60204-1 «Электрооборудование машин» (“Electrical equipment of machines”).

Ответственность за безопасность изделий в эксплуатации и их соответствие требованиям применяемых нормативных документов несет изготовитель или сборщик оборудования, в котором электродвигатели применяются в качестве компонентов и составных частей.

Экономичность – стандарт CEMEP

С целью снижения энергопотребления в Европе CEMEP, Европейский Комитет Производителей Электрического Оборудования, информирует пользователей об экономичности электродвигателей. Для этих целей, CEMEP недавно опубликовал соглашение определяющее экономичность электромоторов по классам **eff1**, **eff2** и **eff3** (от более экономичных к менее экономичным).

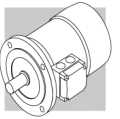

Под данное соглашение попадают только стандартные, 2 и 4 полюсные, трехфазные моторы переменного тока, с закрытым ротором и конструкцией «беличье колесо», с внешней вентиляцией и номинальной мощностью от 1.1 до 90 кВт, Питание – 400В - 50 Гц в непрерывном режиме S1.

Производители оборудования сами классифицируют свою продукцию одним из трех вышеупомянутых классов. Если они решают применить классификацию экономичности, они должны поместить соответствующую маркировку на электродвигатель и включить в список основных технических характеристик соответствующие показатели при полной и 3/4 от номинальной нагрузки. По условиям данного соглашения, электродвигатели Bonfiglioli соответствуют классу экономичности **eff2** и маркируются следующим знаком:



допуски

Разрешенные допуски по основным параметрам в соответствии со стандартом CEI EN 60034-1 приведены в таблице ниже:

(A29)

-0.15 (1 -η) P ≤ 50kW	КПД
-(1 -cosφ)/6 мин 0.02 макс 0.07	Коэффициент мощности
±20% *	Пробуксовка
+20%	Ток на заторможенном роторе
-15% +25%	Момент на заторможенном роторе
-10% *	Максимальный крутящий момент

(*) ± 30% для моторов со значением Pn < 1 кВт

М3 - МЕХАНИЧЕСКИЕ ХАРАКТЕРИСТИКИ

Версии

IEC-стандартизованные VN двигатели доступны в вариантах исполнения, указанных на таблице (A30) как стандарты CEI EN 60034-14.

Доступны следующие варианты:

IM B5 (базовый)

IM V1, IM V3 (производный)

IM B14 (базовый)

IM V18, IM V19 (производный)

Двигатели конструкции IM B5 могут быть установлены в позициях IM V1 и IM V3; Двигатели конструкции IM B14 могут быть установлены в положениях IM V18 и IM V19. В этих случаях, базовое исполнение IM B5 и IM B14 указывается на шильде двигателя. Для вариантов с вертикально расположенным мотором и валом, направленным вниз, рекомендуется заказывать drip cover брызгозащитный кожух.

Кожух фигурирует в списке опций. Заказ этой опции производится отдельно, она не включена в стандартную комплектацию.

(A30)

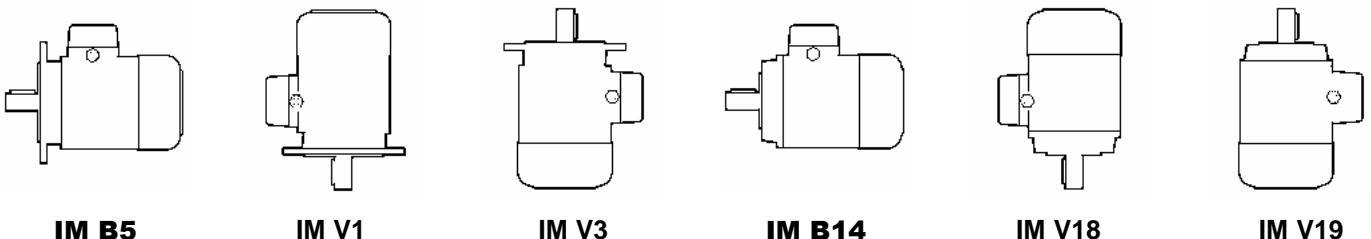

Фланцевые моторы могут поставляться с уменьшенной монтажной поверхностью, как в таблице ниже (A31).

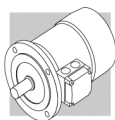

(A31)

	BN 71	BN 80	BN 90	BN 100	BN 112	BN 132
	DxE – Ø					
B5R ⁽¹⁾	11x23	14x30	19x40	24x50	24x50	28x60 -25000
B14R ⁽²⁾	11x23 -90	14x30 -105	19x40 -120	24x50 -140	—	—

⁽¹⁾ фланец со сквозными отверстиями

⁽²⁾ фланец с резьбовыми отверстиями

IP..

Степень защиты

Варианты степеней защиты приведены в таблице ниже.

В дополнение к степени защиты, указанной при заказе, моторы, предназначенные для установки вне помещений требуют защиты от прямых солнечных лучей а в случае установки положением хвостовика вала вниз – оснащения специальным колпаком для защиты от воздействия атмосферных осадков и проникновения в электродвигатель твердых частиц (опция **RC**).

(A32)

		IP 54	IP 55	IP 56
BN	M		Стандартная комплектация	
BN_FD BN_FA	M_FD M_FA	Стандартная комплектация		
BN_BA	—		Стандартная комплектация	

Охлаждение

Электродвигатели оборудованы внешним охлаждением (IC 411 to CEI EN 60034-6) с пластиковым вентилятором, работающим в обоих направлениях.

Электродвигатель должен быть установлен так, чтобы между кожухом вентилятора и ближайшей стенкой оставалось достаточно места, чтобы обеспечить беспрепятственный приток воздуха и доступ к электродвигателю и тормозу.

По специальным заказам электродвигатели оснащаются независимой системой принудительного охлаждения (опция U1).

Данная опция позволяет увеличить коэффициент эксплуатации электродвигателя при его питании через инвертер или работе на пониженных оборотах.

Направление вращения

Возможно вращение валов электродвигателей в обоих направлениях. При подсоединении выводов U1, V1, W1 к фазам L1, L2, L3 вал электродвигателя вращается по часовой стрелке (вид со стороны привода). Обратное направление вращения достигается изменением подсоединения двух фаз.

Уровень шума

Результаты замеров уровня шума по стандарту ISO 1680 соответствуют максимальным пределам, предписанным стандартами CEI EN 60034-9.

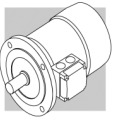

Вибрация и балансировка ротора

Электродвигатели динамически балансируются по классу вибрации N, в соответствии со стандартом CEI EN 60034-14. При необходимости снижения уровня шума по специальному заказу поставляются электродвигатели пониженной вибрации с балансировкой по классу R. В таблице ниже представлены данные о фактической скорости вибрации при обычной балансировке «класс N» и балансировке по классу «R».

(A33)

Класс вибрации	Угловая скорость n [мин ⁻¹]	Предел скорости вибраций [мм/сек]	
		BN 56...BN 132 M05...M4	BN 160MR...BN 200 M5
N	$600 \leq n \leq 3600$	1.8	2.8
R	$600 \leq n \leq 1800$	0.71	1.12
	$1800 < n \leq 3600$	1.12	1.8

Значения получены в результате измерений на свободно подвешенном двигателе при работе без нагрузки.

Соединительная коробка

В соединительной коробке размещены 6 выводных штырей для подключения проводов электропитания. Вывод заземления также располагается в соединительной коробке.

Количество и тип выводных штырей приведены на таблице ниже. Выпрямитель электропитания тормоза (подключение выполнено при сборке) также находится в соединительной коробке.

Для правильного подключения следуйте указаниям схем соединения, расположенных внутри соединительной коробки или приведенных в инструкции по эксплуатации.



(A34)

		Количество выводных штырей	Диаметр резьбы	Макс. Сечение проводника
BN 56...BN 71	M05, M1	6	M4	2.5
BN 80 - BN 90	M2	6	M4	2.5
BN 100...BN 112	M3	6	M5	6
BN 132...BN 160MR	M4	6	M5	6
BN 160M...BN 180M	M5	6	M6	16
BN 180L...BN 200L	—	6	M8	25

Отверстия под уплотнители подводных кабелей

Стандартные отверстия под уплотнители подводных кабелей, рассчитаны на уплотнения кабелей метрических размеров в соответствии со стандартом EN 50262. Размеры отверстий указаны в следующей таблице.

(A35)

		Количество и размер отверстий под уплотнители подводных кабелей	Макс. Допустимый диаметр кабеля [мм]
BN 63	M05	2 x M20 x 1.5	13
BN 71	M1	2 x M25 x 1.5	17
BN 80 - BN 90	M2	2 x M25 x 1.5	17
		2 x M32 x 1.5	21
BN 100	M3	2 x M25 x 1.5	17
		2 x M32 x 1.5	17
BN 112	—	4 x M25 x 1.5	17
BN 132...BN 160MR	M4	2 x M32 x 1.5	21
BN 160M...BN 200L	M5	2 x M40 x 1.5	29

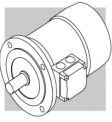

Подшипники

Используются радиальные шариковые подшипники со смазкой на весь период эксплуатации. Типы подшипников указаны в таблице ниже. Расчетный эксплуатационный ресурс L_{10} , в соответствии с ISO 281, при отсутствии нагрузок, превышает 40000 ч.

DE = со стороны двигателя

NDE = с противоположной стороны

(A36)

		DE		NDE	
		M, M_FD, M_FA	M	M_FD; M_FA	
M05		6004 2Z C3	6201 2Z C3	6201 2RS C3	
M1		6004 2Z C3	6202 2Z C3	6202 2RS C3	
M2		6007 2Z C3	6204 2Z C3	6204 2RS C3	
M3		6207 2Z C3	6206 2Z C3	6206 2RS C3	
M4		6309 2Z C3	6308 2Z C3	6308 2RS C3	
M5		6309 2Z C3	6309 2Z C3	6309 2RS C3	

(A37)

		DE		NDE	
		BN, BN_FD, BN_FA, BN_BA	BN, BN_BA	BN_FD; BN_FA	
BN 56		6201 2Z C3	6201 2Z C3	—	
BN 63		6201 2Z C3	6201 2Z C3	6201 2RS C3	
BN 71		6202 2Z C3	6202 2Z C3	6202 2RS C3	
BN 80		6204 2Z C3	6204 2Z C3	6204 2RS C3	
BN 90		6205 2Z C3	6205 2Z C3	6305 2RS C3	
BN 100		6206 2Z C3	6206 2Z C3	6206 2RS C3	
BN 112		6306 2Z C3	6306 2Z C3	6306 2RS C3	
BN 132		6308 2Z C3	6308 2Z C3	6308 2RS C3	
BN 160MR		6309 2Z C3	6308 2Z C3	6308 2RS C3	
BN 160M/L		6309 2Z C3	6309 2Z C3	6309 2RS C3	
BN 180M		6310 2Z C3	6309 2Z C3	6309 2RS C3	
BN 180L		6310 2Z C3	6310 2Z C3	6310 2RS C3	
BN 200L		6312 2Z C3	6310 2Z C3	6310 2RS C3	

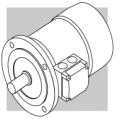

М4 - ЭЛЕКТРИЧЕСКИЕ ХАРАКТЕРИСТИКИ

Работа от сети с частотой 60 Гц

Стандартные односкоростные электродвигатели предназначены для работы от сети электропитания переменного тока номинальным напряжением 230/400В

Допуск в $\pm 10\%$ применяется к номинальному напряжению, за исключением двигателей типа M3LC4 и M3LC6.

двигатели предназначены также для работы от европейских сетей электропитания, соответствующих стандарту IEC 60038.

Помимо номинального напряжения на заводских шильдах электродвигателей указываются допустимые рабочие пределы по напряжению, например,

220-240V Δ , 50Гц.

380-415V Y, 50Гц.

В соответствии со стандартом CEI EN 60034-1, допускается работа электродвигателей при указанных значениях напряжения с допуском $\pm 5\%$.

При работе на пределе допуска температура может превысить предельное значение, соответствующее принятому классу изоляции, на 10 К.

На заводских шильдах всех электродвигателей за исключением двигателей с тормозом постоянного тока типа BN_FD приведены номинальное значение напряжения сети при частоте ниже 60Гц и характеристики сети при питании переменным током 460В при частоте 60Гц с указанием соответствующего диапазона напряжений – 440-480В Y при частоте 60Гц.

Номинальное напряжение для электродвигателей, оснащенных тормозом, типа FD:



220-240В Δ - 50 Гц

380-415В Y - 50 Гц

Напряжение электропитания 230В $\pm 10\%$ переменного тока, одна фаза.



В нижеследующей таблице представлена стандартная и специальная (за дополнительную плату) обмотка моторов.

(A38)

		BN M	BN_FD M_FD		BN_FA / BN_BA M_FA		Конфигурация
		$V_{\text{двиг}} \pm 10\%$ 3~	$V_{\text{двиг}} \pm 10\%$ 3~	$V_{\text{торм}} \pm 10\%$ 1~	$V_{\text{двиг}} \pm 10\%$ 3~	$V_{\text{торм}} \pm 10\%$ 1~	
BN 56 - BN 132	M05...M4	230/400-50Гц 460-60Гц	230/400В Δ /Y-50Гц	230В	230/400В Δ /Y-50Гц 460В Y-60Гц	230/400В Δ /Y-50Гц 460В Y-60Гц	Стандарт
BN 100 - BN 132	M3 - M4	400/690-50Гц 460-60Гц	400/690В Δ /Y-50Гц	400В	400/690В Δ /Y-50Гц 460В Y-60Гц	400/690В Δ /Y-50Гц 460В Y-60Гц	По спец. заказу

Двухскоростные электродвигатели рассчитаны на электропитание от стандартных сетей напряжением 400 В с частотой 50 Гц. Применяемые допуски соответствуют стандарту CEI EN 60034-1. В нижеследующей таблице приведены конфигурации подключения в зависимости от количества полюсов:

(A39)

		Число полюсов	Подключение обмотки
		BN 56...BN 200	M05...M5
		2/4	Δ / YY (Даландер)
		2/6, 2/8, 2/12	Y / Y Две обмотки

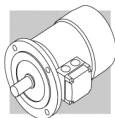

частота

За исключением электродвигателей с тормозом, электродвигатели серии BN предназначены для работы от сети электропитания переменного тока с частотой 50 или 60 Гц в диапазоне напряжения 440-480 В.

Мощность увеличена примерно на 20%. Номинальная мощность при функционировании от 60 Гц приводится в таблице ниже.

(A40)

		2P	4P	6P
		P _n [кВт]		
BN 56A	–	–	0.06	–
BN 56B	M0B	–	0.10	–
BN 63A	M05A	0.21	0.14	0.10
BN 63B	M05B	0.30	0.21	0.14
BN 71A	M05C	0.45	0.30	0.21
BN 71B	M1SD	0.65	0.45	0.30
BN 80A	M1LA	0.90	0.65	0.45
BN 80B	M2SA	1.30	0.90	0.65
BN 90S	M2SB	–	1.30	0.90
BN 90SA	M2SB	1.8	–	–
BN 90L	M3SA	2.5	–	1.3
BN 90LA	M3SA	–	1.8	–
BN 100L	M3LA	3.5	–	–
BN 100LA	M3LA	–	2.5	1.8
BN 100LB	M3LB	4.7	3.5	2.2
BN 112M	M3LB	4.7	4.7	2.5
	M3LC	–	4.7	2.5
BN 132S	M4SA	–	6.5	3.5
BN 132SA	M4SA	6.3	–	–
BN 132SB	M4SB	8.7	–	–
BN 132M	M4LA	11	–	–
BN 132MA	M4LA	–	8.7	4.6
BN 132MB	M4LB	–	11	6.5
BN 160MR	M4LC	12.5	12.5	–
BN 160MB	M5SB	17.5	–	–
BN 160M	M5SA	–	–	8.6
BN 160L	M5S	21.5	17.5	12.6
BN 180M	M5LA	24.5	21.5	–
BN 180L	–	–	25.3	17.5
BN 200L	–	34	34	22

Повышение мощности двухскоростных электродвигателей при питании от сети с частотой 60 Гц по сравнению с их мощностью при питании от сети с частотой 50 Гц составляет около 15%. Ниже приведены данные (в процентах) об изменении основных характеристик однополюсных моторов со стандартной обмоткой при питании от сети с частотой 60 Гц и напряжении, указанном в таблице

(A41)

50 Гц	60 Гц			
B - 50Гц	B - 60Гц	P _n - 60Гц	M _n , M _a /M _n - 60Гц	n [мин ⁻¹] - 60Гц
230/400 Δ/Y	220 - 240 Δ	1	0.83	1.2
	380 - 415 Y			
400/690 Δ/Y	380 - 415 Δ			
230/400 Δ/Y	265 - 280 Δ	1.15	1	1.2
	440 - 480 Y			
400/690 Δ/Y	440 - 480 Δ			

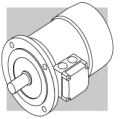

Номинальная мощность

В таблицах настоящего каталога приводятся технические характеристики электродвигателей при их работе от сети с частотой 50 Гц согласно стандартам CEI EN 60034-1 (температура от -15 до 40 °С; высота над ур. моря < 1000 м). Допускается эксплуатация электродвигателей при температурах 40 - 60 °С с учетом коэффициентов снижения мощности, указанных в таблице.

(A42)

Температура окружающей среды	40°	45°	50°	55°	60°
Допустимая мощность в % от номинальной	100%	95%	90%	85%	80%

В случае необходимости эксплуатации электродвигателей в условиях, вызывающих снижение мощности более, чем на 15% рекомендуется обратиться в Отдел технического обслуживания компании-изготовителя).

Класс изоляции

CL F

В электродвигателях Bonfiglioli в стандартном исполнении применяются изоляционные материалы класса **F** (эмалированная проволока, изоляторы, пропитка смолами).

CL H

По специальным заказам изготавливаются электродвигатели с изоляцией класса **H**.

Нагрев обмоток статора стандартных электродвигателей обычно не превышает предела по нагреву класса В, равного 80 К. Благодаря тщательному подбору изоляционных материалов электродвигатели пригодны для работы в жарком климате и в условиях обычной вибрации.

В случае необходимости эксплуатации двигателя в среде с присутствием агрессивных химических веществ или при высокой влажности для оптимального выбора двигателя рекомендуется обратиться за консультацией в отдел технической поддержки компании Bonfiglioli.

(A43)

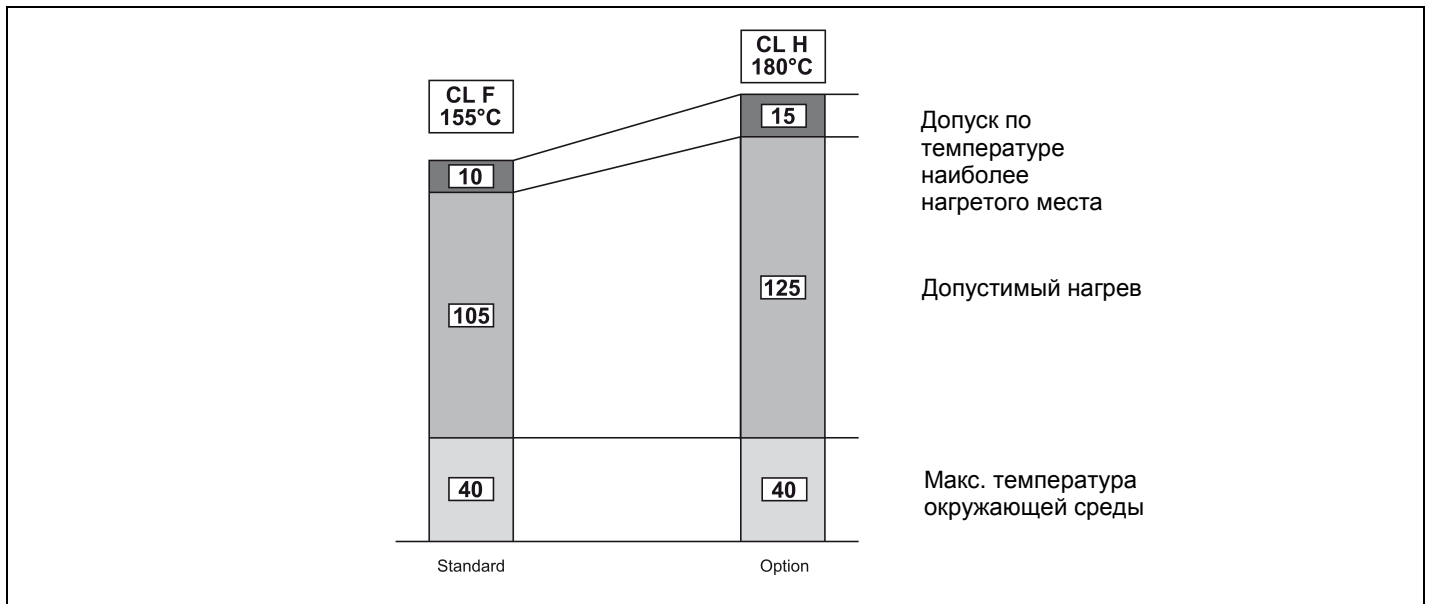

Тип нагрузки

При отсутствии иных указаний, приводимые в настоящем каталоге данные о мощности электродвигателей относятся к непрерывному режиму работы S1. Условия эксплуатации, отличные от режима S1, определяются в соответствии со стандартами CEI EN 60034-1. Для режимов работы S2 и S3 применяются коэффициенты увеличения мощности, указанные в таблице (A44) ниже. При этом следует учитывать, что данные, приведенные в таблице, относятся к односкоростным электродвигателям. Информацию о коэффициентах увеличения мощности для двухскоростных электродвигателей можно получить в отделе технического обслуживания компании Bonfiglioli.

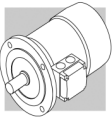

(A44)

	Нагрузка						Связаться с производителем
	S2			S3 *			
	Продолжительность цикла (мин)			Фактор длительности цикла (I)			
	10	30	60	25%	40%	60%	
f_m	1.35	1.15	1.05	1.25	1.15	1.1	

* Продолжительность цикла должна в любом случае быть меньше либо равняться 10 минутам; если продолжительность цикла превышает 10 минут, просьба связаться с сервисной службой производителя.

Фактор продолжительности цикла:

$$I = \frac{t_f}{t_f + t_r} \cdot 100 \quad (23)$$

t_f = время работы при постоянной нагрузке

t_r = время покоя

Работа при постоянной нагрузке S2

Работа при постоянной нагрузке в течение ограниченного периода времени (меньшего, чем необходимый для достижения теплового баланса), за которым следует период покоя, достаточный для охлаждения двигателя до температуры окружающей среды.

Последовательность аналогичных циклов работы S3:

Последовательность аналогичных циклов работы, каждый из которых состоит из периода работы при постоянной нагрузке, за которым следует определенный период покоя. При таком режиме работы начальный ток не оказывает существенного влияния на перегрев.

Питание через инвертер

Электропитание двигателей VN может осуществляться через инвертер на основе широтно-импульсного модулятора с номинальным напряжением на входе трансформатора до 500 В. В системе изоляции электродвигателей в стандартном исполнении применены изоляция фаз с сепараторами, эмалированная проволока класса 2 и пропитка специальной смолой класса H (максимальная двойная амплитуда импульса напряжения на выводах двигателя 1600В, фронт подъема $t_s > 0,1$ мкс). Данные о рабочих значениях крутящего момента и скорости вращения вала двигателей при эксплуатации в режиме S1 с основной частотой тока питания $f_b = 50$ Гц приведены в таблице ниже. Поскольку работа на частотах ниже 30 Гц приводит к значительному снижению эффективности охлаждения, стандартные двигатели со встроенным вентилятором (IC 411) требуют соответствующего снижения крутящего момента либо дооснащения вентилятором с автономным питанием (см. разд. M12). При работе на частотах выше основного значения, по достижении максимального напряжения на выходе инвертера двигатель работает в стабильном режиме с уменьшением крутящего момента на валу, приблизительно равным отношению f/f_b . Поскольку максимальный крутящий момент двигателя уменьшается приблизительно пропорционально $(f/f_b)^2$, необходимо постепенное снижение допустимого предела нагрузки.

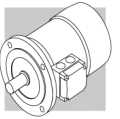

(A45)

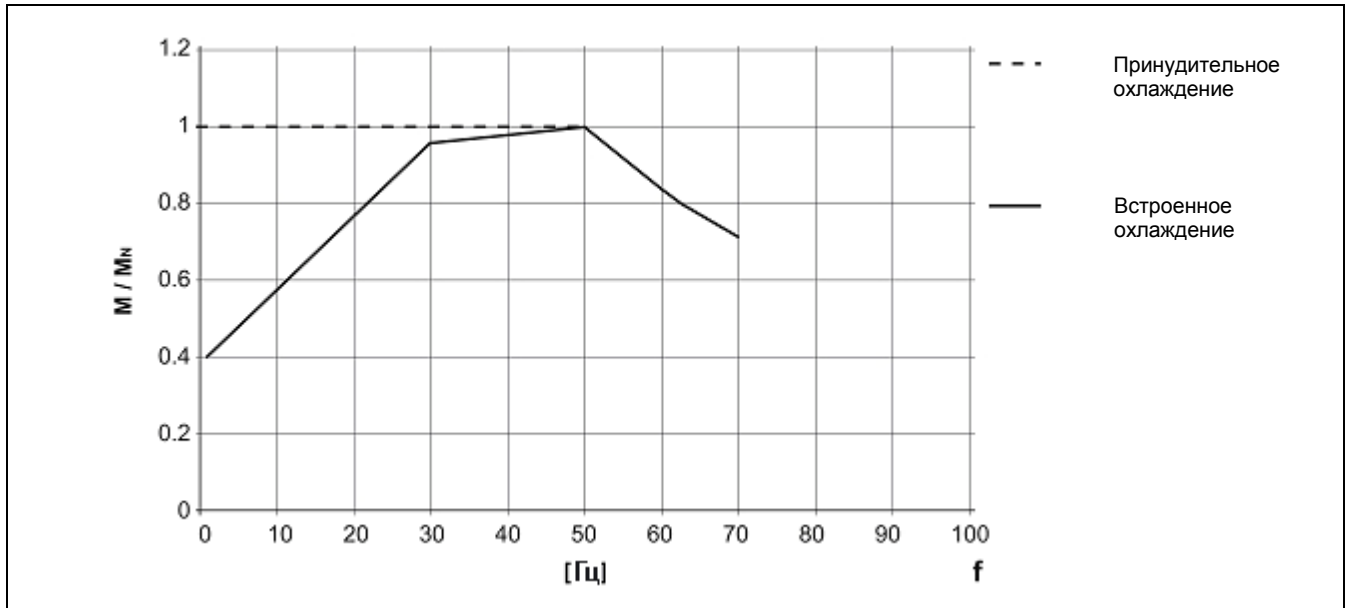

Механические пределы скорости вращения при работе электродвигателей на частотах, превышающих номинальную, указаны в следующей таблице:

(A46)

		n [мин ⁻¹]		
		2p	4p	6p
≤ BN 112	M05...M3	5200	4000	3000
BN 132...BN 200L	M4, M5	4500	4000	3000

При работе электродвигателей на скоростях выше номинальной увеличивается вибрация и шум вентилятора. В этом случае рекомендуется применять ротор, отбалансированный по классу R – исполнение **RV**, и вентилятор с автономным питанием – исполнения **U1** или **U2**. Сервоventильатор и электромагнитный тормоз должны быть подключены непосредственно к источнику питания.

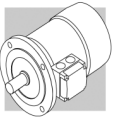

Максимальная частота включений

Для всех типов тормозов в таблице технических характеристик указана максимальная частота включений за час при отсутствии нагрузки Z_0 с относительной продолжительностью включения $I = 50\%$. Данная величина показывает, сколько запусков в час без нагрузки выдерживает двигатель без превышения температурного предела для класса изоляции F

В случае, когда вал двигателя находится под внешней нагрузкой с потребляемой мощностью P_r , инертной массой J_c и средним начальным нагружающим моментом M_L , максимальная частота включений вычисляется по формуле:

$$Z = \frac{Z_0 \cdot K_c \cdot K_d}{K_J}$$

где

$K_J = (J_m + J_c) / J_m =$ коэффициент инерции;

$K_c = (M_a - M_L) / M_a =$ коэффициент крутящего момента;

$K_d =$ коэффициент нагрузки.

См таблицу ниже:

(A47)

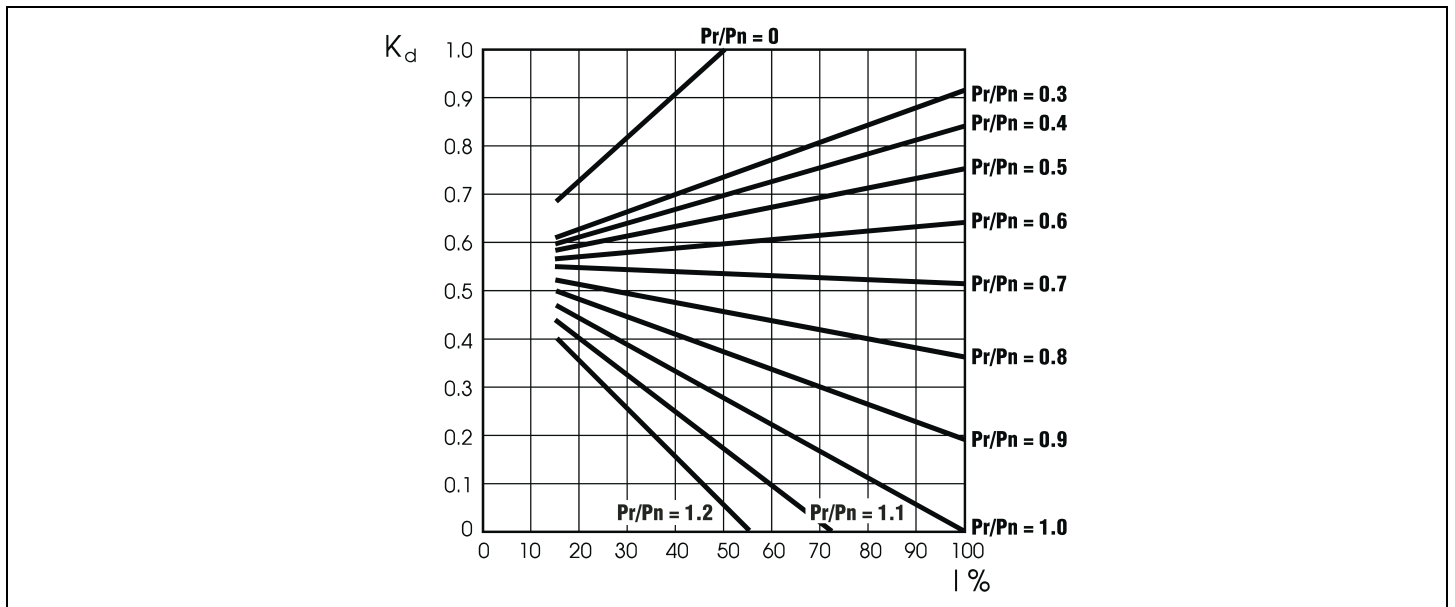

Рассчитав таким образом максимально допустимую частоту включений Z , необходимо убедиться, что при полученной частоте включений максимальная энергия торможения совместима с теплоемкостью тормоза $W_{\text{макс}}$ также приведенной в таблице (A54) и зависящей от количества включений (с/ч).

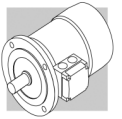

М5 - ЭЛЕКТРОДВИГАТЕЛИ С ТОРМОЗОМ

Устройство и принцип работы

В исполнениях электродвигателей со встроенным тормозом применяются пружинные тормоза постоянного (исполнение FD) или переменного (исполнения FA и BA) тока.

Все варианты конструкции тормоза предусматривают безотказность в работе за счет механического действия посредством пружин в случае сбоя в подаче электропитания.

(A48)

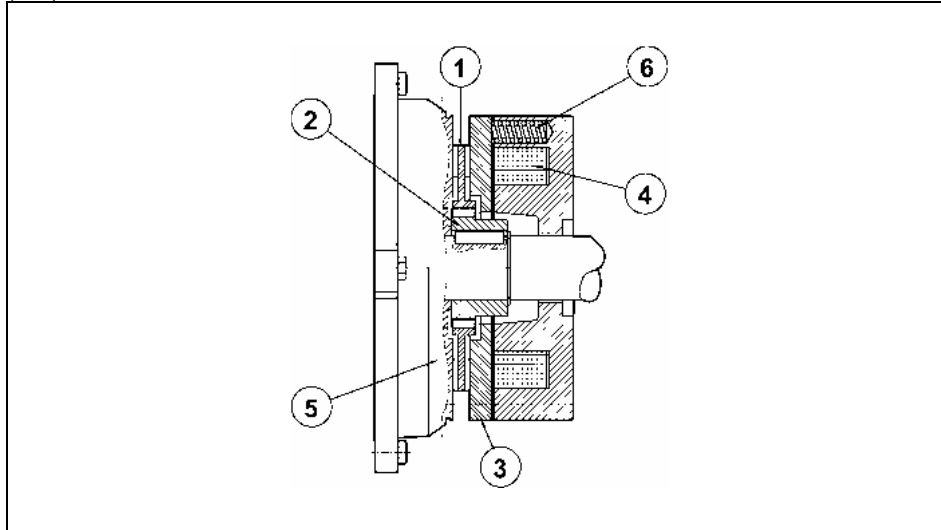

Пояснения:

- 1 – диск тормоза
- 2 – ступица диска
- 3 – нажимная пластина
- 4 – катушка тормоза
- 5 – задняя крышка корпуса двигателя
- 6 – тормозные пружины

При прекращении подачи напряжения нажимная пластина прижимается к диску пружинами. При этом диск оказывается зажатым между нажимной пластиной и задней крышкой корпуса двигателя, вследствие чего вращение вала прекращается. При подаче тока на катушку нажимная пластина притягивается к ней магнитным полем, достаточным для преодоления сопротивления пружин, благодаря чему диск, закрепленный на валу двигателя, освобождается.

Общие особенности конструкции тормоза:

- высокий тормозной момент (обычно $M_b \approx 2 M_n$) с возможностью регулировки;
- стальной диск с фрикционными накладками с обеих сторон (накладки износостойкие, безасбестные);
- шестигранник на валу со стороны вентилятора для вращения вручную (неприменимо к электродвигателям с двусторонним валом привода (модификация PS), а также к двигателям в исполнениях RC, TC, U1, U2, EN1, EN2 и EN3;
- возможность оснащения рычагом ручной разблокировки тормоза (варианты исполнения **R** и **RM** для тормозов BN_FD и BN_FA;
- антикоррозионная обработка всех поверхностей тормоза;
- класс изоляции F

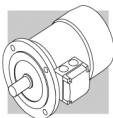

M6 - ЭЛЕКТРОДВИГАТЕЛИ С ТОРМОЗОМ ПОСТОЯННОГО ТОКА ТИПА BN_FD

Размеры корпусов: BN 63 ... BN 200L
(A49)

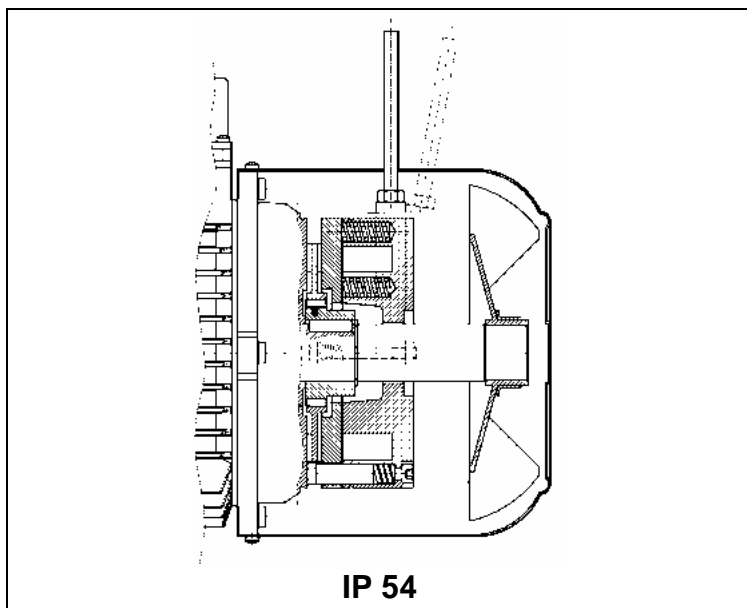

(A50)

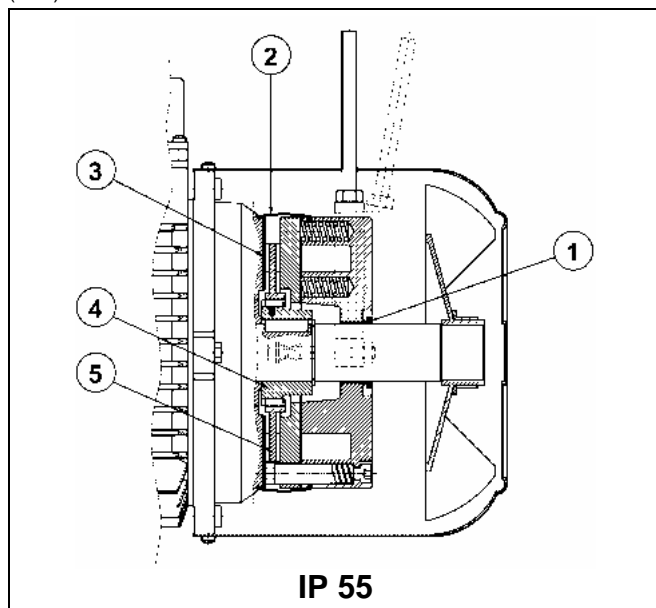

Электромагнитный тормоз постоянного тока с тороидальной катушкой закреплен болтами на корпусе двигателя. Осевое расположение электромагнита обеспечивается пружинами с предварительным натягом. Диск тормоза, снабженный antivибрационной пружиной, может перемещаться вдоль оси посаженной на вал стальной ступицы.

Заводская установка тормозного момента указана в таблице технических характеристик соответствующей модели электродвигателя. Возможна регулировка тормозного момента путем изменения типа и/или количества пружин.

По заказу электродвигатели оборудуются рычагом ручной разблокировки тормоза с автоматическим возвращением в исходное состояние (исполнение R) или с возможностью фиксации в разблокированном положении (исполнение RM).

Тормоз FD обладает оптимальными динамическими характеристиками при низком уровне шума. Рабочие характеристики тормоза постоянного тока могут быть скорректированы в соответствии с предъявляемыми конкретными требованиями путем выбора оптимального варианта выпрямителя/источника питания и схемы подключения.

Степень защиты

Степень защиты в стандартном варианте исполнения – IP54. Возможно также исполнение электродвигателей с тормозом FD со степенью защиты IP 55. Такое исполнение имеет следующие отличия:

- 1) уплотнительное кольцо на конце вала со стороны, противоположной приводу;
- 2) пылеводозащитный резиновый кожух;
- 3) кольцо из нержавеющей стали между щитком корпуса двигателя и диском тормоза;
- 4) ступица диска из нержавеющей стали;
- 5) диск тормоза из нержавеющей стали.

Электропитание тормоза FD

Электропитание катушки тормоза постоянного тока осуществляется через выпрямитель, находящийся внутри соединительной коробки. Подключение выпрямителя к тормозу выполнено при изготовлении. Во всех односкоростных двигателях выпрямитель подключен к выводному щитку двигателя. Стандартные значения напряжения питания выпрямителя V_B независимо от частоты тока в сети приведено в следующей таблице:

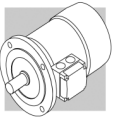

(A51)

2, 4, 6 P					1 скорость
		BN_FD / M_FD		Подключение питания тормоза из клемной коробки электродвигателя	Отдельное питание тормоза
		$V_{\text{двиг}} \pm 10\%$ 3~	$V_{\text{торм}} \pm 10\%$ 1~		
BN 63...BN 132	M05...M4LB	230/400V-50Hz	230V	Стандарт	В заказе указывается $V_B SA$ или $V_B SD$
BN 160...BN 200	M4LC...M5	400/690V-50Hz	400V	Стандарт	В заказе указывается $V_B SA$ или $V_B SD$

В двухскоростных электродвигателях электропитание тормоза осуществляется через выпрямитель с отдельным подключением. Напряжение питания выпрямителя приведено в следующей таблице:

(A52)

2/4, 2/6, 2/8, 2/12, 4/6, 4/8 P					2 скорости
		BN_FD / M_FD		Подключение питания тормоза из клемной коробки электродвигателя	Отдельное питание тормоза
		$V_{\text{двиг}} \pm 10\%$ 3~	$V_{\text{торм}} \pm 10\%$ 1~		
BN 63...BN 132	M05...M4LB	400В-50 Hz	230V		В заказе указывается $V_{\text{торм}} SA$ или $V_{\text{торм}} SD$

Однополупериодный диодный выпрямитель (напряжение постоянного тока $\approx 0,45$ x напряжение переменного тока) поставляется в вариантах исполнения NB, SB, NBR и SBR (см. таблицу ниже):

(A53)

		ТОРМОЗ				
			Стандартное исполнение	По запросу		
BN 63	M05	FD 02				
BN 71	M1	FD 03			NB	SBR
		FD 53				NB
BN 80	M2	FD 04				
BN 90S	—	FD 14				
BN 90L	—	FD 05				
BN 100	M3	FD 15		SBR		
—		FD 55				
BN 112	—	FD 06S			SBR	
BN 132...160MR	M4	FD 56				
BN 160L - BN 180M	M5	FD 06				
BN 180L - NM 200L	—	FD 07				

(*) $t_{2c} < t_{2r} < t_2$

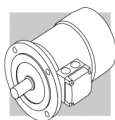

При подаче питания на выпрямитель с электронным управлением возбуждения **SB** происходит перевозбуждение электромагнита, благодаря чему сокращается время разблокировки тормоза. После разблокировки выпрямитель переходит в обычный однополупериодный режим работы.

Применение выпрямителя **SB** необходимо в следующих случаях:

- высокая частота включений в час;
- необходимость сокращения времени разблокировки тормоза;
- высокая тепловая нагрузка на тормоз.

Выпрямители **NBR** или **SBR** предназначены для применения в случаях, когда к скорости разблокировки тормоза предъявляются особо строгие требования.

Указанные модификации выпрямителей расширяют возможности моделей **NB** и **SB**, поскольку в их схему входит статический выключатель, который при прекращении подачи электропитания мгновенно обесточивает тормоз.

Благодаря такому устройству обеспечивается сокращение времени разблокировки тормоза при отсутствии необходимости подключения дополнительных внешних устройств и подведения дополнительных внешних кабелей.

Оптимальные рабочие характеристики выпрямителей **NBR** и **SBR** достигаются при раздельном электропитании двигателя и тормоза.

Варианты напряжения электропитания: 230В ± 10%, 400В ± 10%, 50/60 Гц.

Технические характеристики тормоза FD

Технические данные тормозов постоянного тока FD приведены в следующей таблице:

(A54)

Тормоз	Тормозной момент M _b , Нм			Разблокировка		Торможение		W _{max} на 1 торможение, Дж			W, МДж	P _b , Вт
	Количество пружин			t ₁ [мс]	t _{1s} [мс]	t ₂ [мс]	t _{2c} [мс]	10 Вкл/ч	100 Вкл/ч	1000 Вкл/ч		
	6	4	2									
FD 02	-	3,5	1,75	30	15	80	9	4500	1400	180	15	17
FD03	5	3,5	1,75	50	20	100	12	7000	1900	230	25	24
FD53	7,5	5	2,5	60	30	100	12					
FD04	15	10	5	80	35	140	15	10000	3100	350	30	33
FD14												
FD05	40	26	13	130	65	170	20	18000	4500	500	50	45
FD15	40	26	13	130	65	170	20					
FD55	55	37	18	-	65	170	20					
FD06S	60	40	20	-	80	220	25	20000	4800	550	70	55
FD56	-	75	37	-	90	150	20	29000	7400	800	80	65
FD06		100	50		100	20						
FD07	150	100	50	-	120	200	25	40000	9300	1000	130	65
FD08*	250	200	170	-	140	350	30	60000	14000	1500	230	100
FD09**	400	300	200	-	200	450	40	70000	15000	1700	230	120

* значения тормозного момента, полученные с 9, 7 и 6 пружинами соответственно

** значения тормозного момента, полученные с 12, 9 и 6 пружинами соответственно

Обозначения:

t₁ = время разблокировки тормоза с однополупериодным выпрямителем

t_{1s} = время разблокировки тормоза с перевозбуждающим выпрямителем

t₂ = время блокировки тормоза после прекращения подачи питания переменного тока при отдельном электропитании

t_{2c} = время блокировки тормоза после прекращения подачи питания переменного и постоянного тока при отдельном электропитании

Значения t₁, t_{1s}, t₂, t_{2c}, приведенные в таблице (A54), указаны для тормоза, отрегулированного на максимальный тормозной момент, со средним зазором между диском и прижимной пластиной при номинальном напряжении питания.

W_{max} = максимальная энергия на одно торможение

W = энергия торможения между двумя последовательными регулировками зазора

P_b = мощность, потребляемая тормозом при 20°C

M_b = статический тормозной момент (± 15%)

вкл/ч = количество включений в час

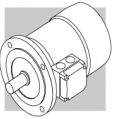

Подключение тормоза FD

В односкоростных электродвигателях стандартного исполнения выпрямитель подключается к выводному щитку при сборке электродвигателя на заводе. Для двухскоростных электродвигателей и при автономном электропитании тормоза напряжение питания выпрямителя должно соответствовать номинальному напряжению электропитания тормоза FD, указанному на заводской шильде.

Ввиду индуктивного характера нагрузки в устройствах управления тормозом и выключения электропитания постоянного тока должны применяться контакты класса AC-3 в соответствии со стандартом IEC 60947- 4-1.

Схема (55) – Электропитание тормоза от выводов питания электродвигателя; прерывание электропитания переменного тока. Задержка времени остановки t_2 и функция временных постоянных электродвигателя. Применяется в случае необходимости плавного разгона и плавного торможения.

Схема (56) – Катушка тормоза с автономным электропитанием и прерывание электропитания переменного тока. Обычное время торможения; работа тормоза не зависит от электродвигателя.

Схема (57) – Электропитание тормоза от выводов питания электродвигателя; прерывание электропитания переменного/постоянного тока. Быстрая остановка, время срабатывания t_{2c} .

Схема (58) - Катушка тормоза с автономным электропитанием и прерывание электропитания переменного/постоянного тока. Время остановки уменьшается на значение t_{2c} .

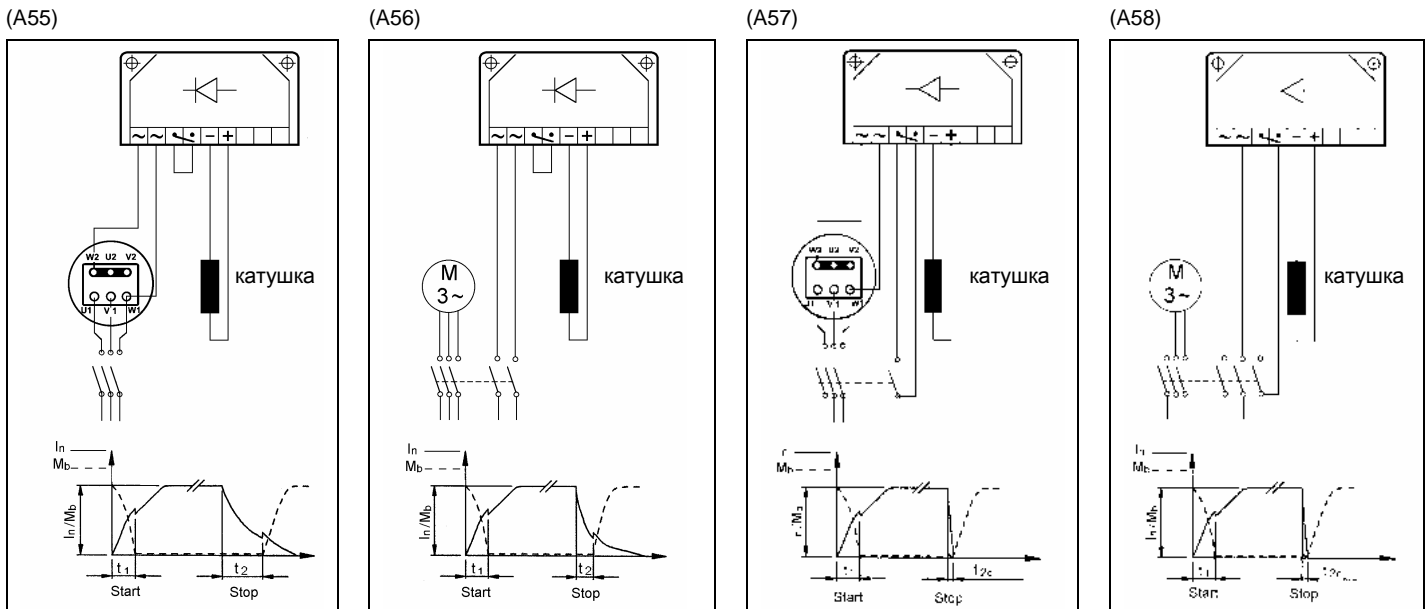

На схемах (55)-(58) показаны диаграммы соединений для электродвигателей номинальным напряжением 230/400В, соединенных звездой, при напряжении электропитания 400В с тормозом 230В.

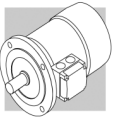

M7 - ЭЛЕКТРОДВИГАТЕЛИ С ТОРМОЗОМ ПЕРЕМЕННОГО ТОКА ТИПА BN_FA

Размеры корпусов: BN 63 ... BN 180M

(A59)

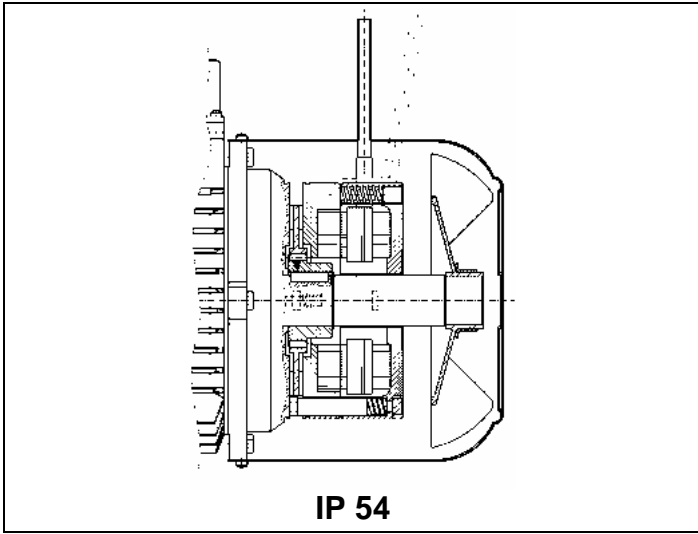

IP 54

(A60)

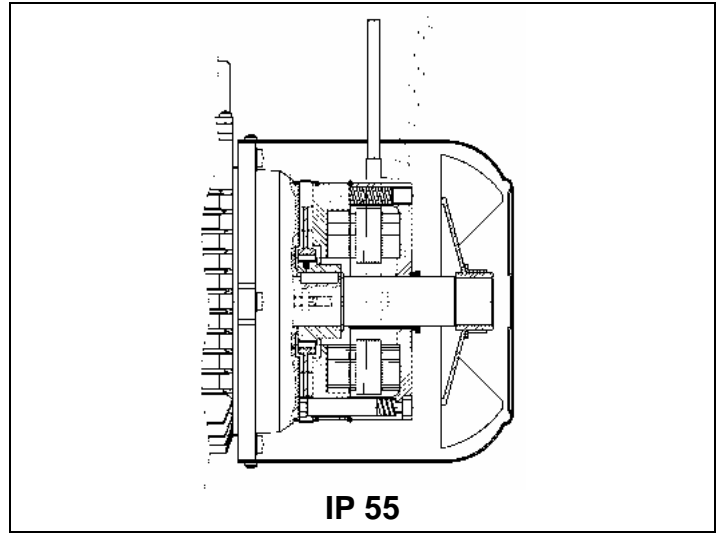

IP 55

Электромагнитный тормоз с питанием от трехфазной сети переменного тока закреплен болтами на корпусе двигателя. Осевое расположение электромагнита обеспечивается пружинами с предварительным натягом. Диск тормоза, снабженный антивибрационной пружиной, может перемещаться вдоль оси посаженной на вал стальной ступицы.

Заводская установка тормозного момента указана в таблице технических характеристик соответствующей модели электродвигателя.

Плавная настройка тормозного момента осуществляется винтами регулировки натяга пружин. Диапазон настройки тормозного момента составляет $30\% M_{b\text{МАКС}} < M_b < M_{b\text{МАКС}}$ (где $M_{b\text{МАКС}}$ – максимальный тормозной момент, указанный в таблице (62)). Благодаря своим высоким динамическим характеристикам тормоз FA идеально подходит для применения в тяжелых условиях эксплуатации, при высокой частоте запусков и остановок, а также при наличии строгих требований к скорости срабатывания.

По заказу электродвигатели оборудуются рычагом ручной разблокировки тормоза с автоматическим возвращением в исходное состояние (исполнение R). Варианты расположения рычага разблокировки см. на с. 164.

Степень защиты

Степень защиты в стандартном варианте исполнения – IP 54. Возможно также исполнение электродвигателей BN_FA со степенью защиты IP 55. Такое исполнение имеет следующие отличия:

- уплотнительное кольцо на конце вала со стороны, противоположной приводу;
- пылеводозащитный резиновый кожух;
- уплотнительное кольцо-прокладка.

Электропитание тормоза FA

В односкоростных двигателях катушка тормоза напрямую подключена к выводному щитку двигателя; следовательно, напряжение питания тормоза равно напряжению питания двигателя. В данном случае напряжение питания тормоза в маркировке двигателя может быть опущено.

В двухскоростных электродвигателях и в двигателях с автономным питанием тормоза контакты электропитания тормоза выведены на отдельный щиток с 6 выводами. При этом в обоих случаях указание напряжения питания тормоза в маркировке двигателя обязательно.

Стандартные значения напряжения питания тормозов переменного тока для односкоростных и двухскоростных двигателей приведены в следующих таблицах:

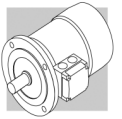

(A61)

Однополюсный мотор	BN 63...BN 132	BN 160...BN 180
	M05...M4LB	M4LC...M5
	230Δ / 400Y В ±10% – 50 Гц	400Δ / 690YВ±10%–50Гц
	265Δ / 460Y В ±10% – 60 Гц	460Y – 60 Гц

двухскоростные электродвигатели (двигатели с автономным питанием тормоза)	BN 63...BN 132
	M05...M4
	230Δ / 400Y В ±10% – 50 Гц
	460Y – 60 Гц

В отсутствие особых указаний, стандартное напряжение питания тормоза 230 Δ / 400Y В - 50 Гц.

По специальным заказам поставляются двигатели с иным напряжением питания тормоза в диапазоне 24...690В, 50 ... 60Гц.

Технические характеристики тормоза FA

(A62)

Тормоз	Тормозной Момент M_b Нм	Разблокировка t_1 [мс]	Торможение t_2 [мс]	W _{макс} [Дж]			W [мДж]	P _b [Вт]
				10 Вкл/ч	100 Вкл/ч	1000 Вкл/ч		
FA 02	3.5	4	20	4500	1400	180	15	60
FA 03	7.5	4	40	7000	1900	230	25	80
FA 04	15	6	60	10000	3100	350	30	110
FA 14								
FA 05	40	8	90	18000	4500	500	50	250
FA 15								
FA 06S	60	16	120	20000	4800	550	70	470
FA 06	75	16	140	29000	7400	800	80	550
FA 07	150	16	180	40000	9300	1000	130	600
FA 08	250	20	200	60000	14000	1500	230	1200

Обозначения:

M_b - статический тормозной момент ($\pm 15\%$)

t_1 - время разблокировки тормоза

t_2 - время блокировки тормоза

$W_{\text{макс}}$ - максимальная энергия на одно торможение (теплоемкость тормоза)

W - энергия торможения между двумя последовательными регулировками зазора

P_b - мощность, потребляемая тормозом при 20°C (50Гц)

вкл/ч - количество включений в час

ПРИМЕЧАНИЕ

Значения t_1 , и t_2 указаны для тормоза, отрегулированного на номинальный тормозной момент, со средним зазором между диском и прижимной пластиной и при номинальном напряжении питания.

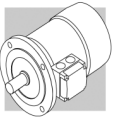

Подключение тормоза FA

Подключение тормоза к контактам в соединительной коробке двигателя при прямом подсоединении питания тормоза к электропитанию двигателя показано на схеме (63)

(A63)

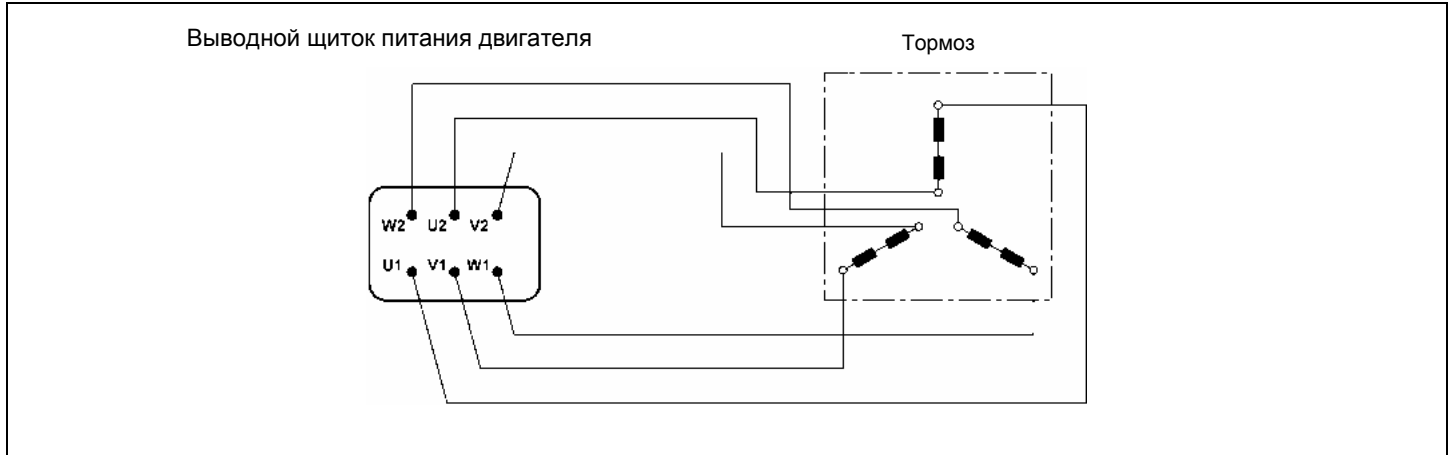

Двухскоростные и изготавливаемые по специальным заказам односкоростные электродвигатели с автономным питанием имеют в соединительной коробке дополнительный шестиконтактный выводной щиток электропитания тормоза. Электродвигатели таких модификаций оснащаются соединительными коробками большего размера. Подключение электропитания тормоза показано на схеме (64)

(A64)

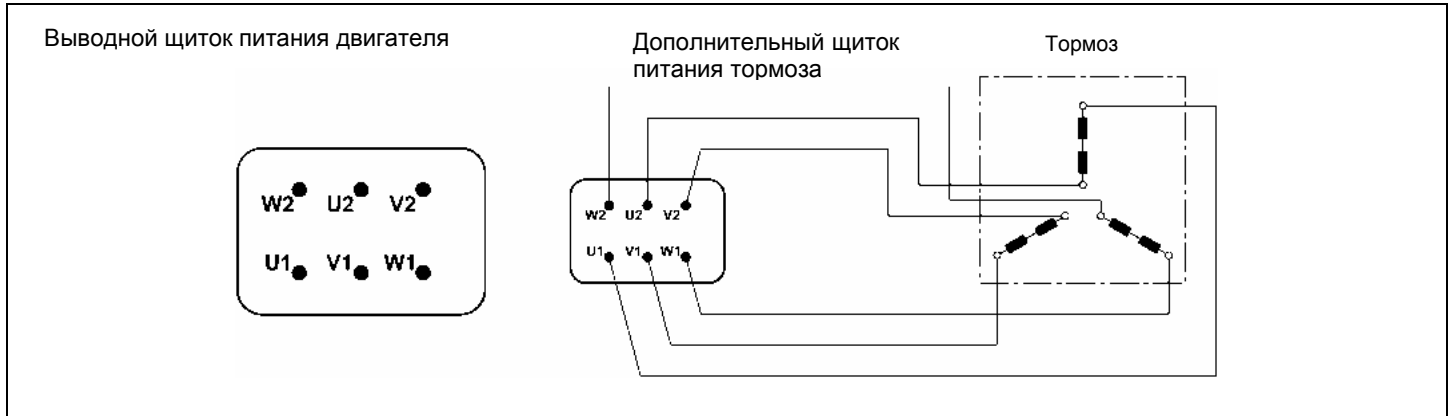

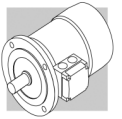

М8 - ЭЛЕКТРОДВИГАТЕЛИ С ТОРМОЗОМ ПЕРЕМЕННОГО ТОКА ТИПА ВN_ВA

Размеры корпусов: ВN 63 ... ВN 132М

(А65)

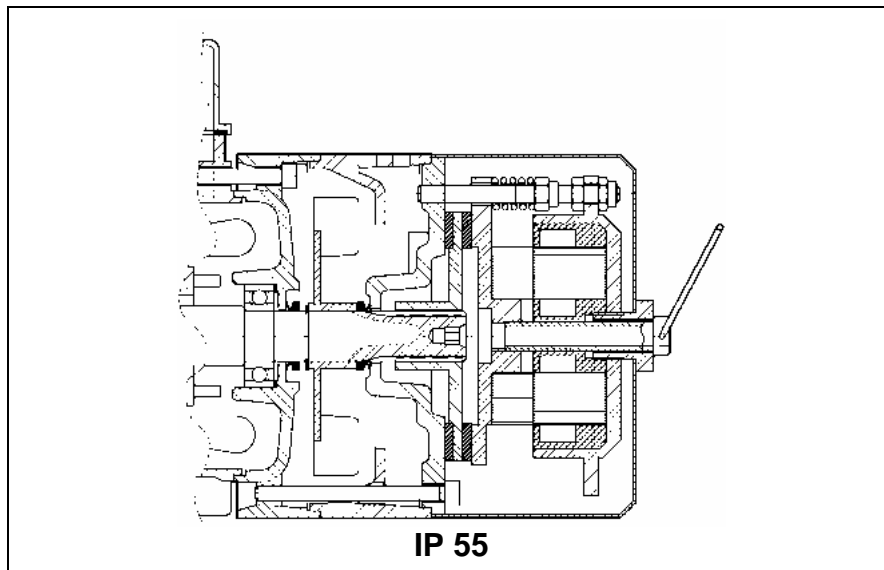

Электромагнитный тормоз с питанием от трехфазной сети переменного тока закреплен болтами на корпусе двигателя. Стальной диск тормоза перемещается по шлицам вдоль оси шлицевого вала (на двигателях размера 132 применяется диск со стальной ступицей, посаженной на вал).

При сборке производится регулировка тормоза на максимальное значение тормозного момента.

Плавная настройка тормозного момента осуществляется винтами регулировки натяга пружин. Диапазон допустимой настройки тормозного момента составляет $30\% M_{\text{бМАКС}} < M_{\text{б}} < M_{\text{бМАКС}}$ (где $M_{\text{бМАКС}}$ – максимальный тормозной момент, указанный в таблице (66))

В стандартном исполнении электродвигатели оборудуются винтом ручной разблокировки тормоза, который фиксируется в положении разблокировки для свободного вращения вала двигателя. По окончании работ, требующих разблокировки, в целях обеспечения нормальной работы тормоза винт необходимо удалить.

Благодаря своим высоким динамическим характеристикам, прочности конструкции и повышенной энергии торможения, тормоз ВA идеально подходит для применения в тяжелых условиях эксплуатации, при высокой частоте запусков и остановок, а также при наличии особо строгих требований к скорости срабатывания.

Степень защиты

Степень защиты всех электродвигателей ВN_ ВA – IP 55.

Электропитание тормоза ВA

В односкоростных двигателях катушка тормоза напрямую подключена к выводному щитку двигателя; следовательно, напряжение питания тормоза равно напряжению питания двигателя. В данном случае напряжение питания тормоза в маркировке двигателя может быть опущено.

В двухскоростных электродвигателях и в двигателях с автономным питанием тормоза контакты электропитания тормоза выведены на отдельный щиток с 6 выводами. При этом в обоих случаях указание напряжения питания тормоза в маркировке двигателя обязательно.

Стандартные значения напряжения питания тормозов переменного тока для односкоростных и двухскоростных двигателей приведены в следующих таблицах:

(А65)

односкоростные электродвигатели	ВN 63...ВN 132
	230Δ / 400У В ±10% – 50 Гц
	265Δ / 460У В ±10% – 60 Гц
двухскоростные электродвигатели (двигатели с автономным питанием тормоза)	ВN 63...ВN 132
	230Δ / 400У В ±10% – 50 Гц
	460У – 60 Гц

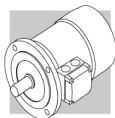

Напряжение и частота тока электропитания тормоза двигателей в стандартном исполнении – 230Δ / 400Y В ±10% – 50 Гц.

По специальным заказам поставляются двигатели с иным напряжением питания тормоза в диапазоне 24...690 В, 50 ... 60Гц.

Технические характеристики тормоза ВА

В таблице (А66) указаны технические характеристики АС тормозов типа ВА.

(А66)

Brake	Момент тормоза M _b [Нм]	Разблокировка t ₁ [мс]	Торможение t ₂ [мс]	W _{макс} [Дж]			W [мДж]	P _b [Вт]
				10 Вкл/ч	100 Вкл/ч	1000 Вкл/ч		
ВА 60	5	5	20	4000	1500	180	30	60
ВА 70	8	6	25	7000	2700	300	60	75
ВА 80	18	6	25	10000	3100	350	80	110
ВА 90	35	8	35	13000	3600	400	88	185
ВА 100	50	8	35	18000	4500	500	112	225
ВА 110	75	8	35	28000	6800	750	132	270
ВА 140	150	15	60	60000	14000	1500	240	530

Обозначения:

M_b = статический тормозной момент (± 15%)

t₁ = время разблокировки тормоза

t₂ = время блокировки тормоза

W_{макс} = максимальная энергия на одно торможение (теплоемкость тормоза)

W = энергия торможения между двумя последовательными регулировками зазора

P_b = мощность, потребляемая тормозом при 20°C (50Гц)

вкл/ч = количество включений в час

ПРИМЕЧАНИЕ

Значения t₁, и t₂, приведенные в таблице (62), указаны для тормоза, отрегулированного на номинальный тормозной момент, со средним зазором между диском и прижимной пластиной и при номинальном напряжении питания.

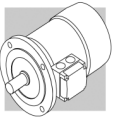

Соединение тормоза ВА

Схема (А67) показывает присоединение к клеммной коробке в случае, когда тормоз должен быть присоединен напрямую к питанию двигателя.

(А67)

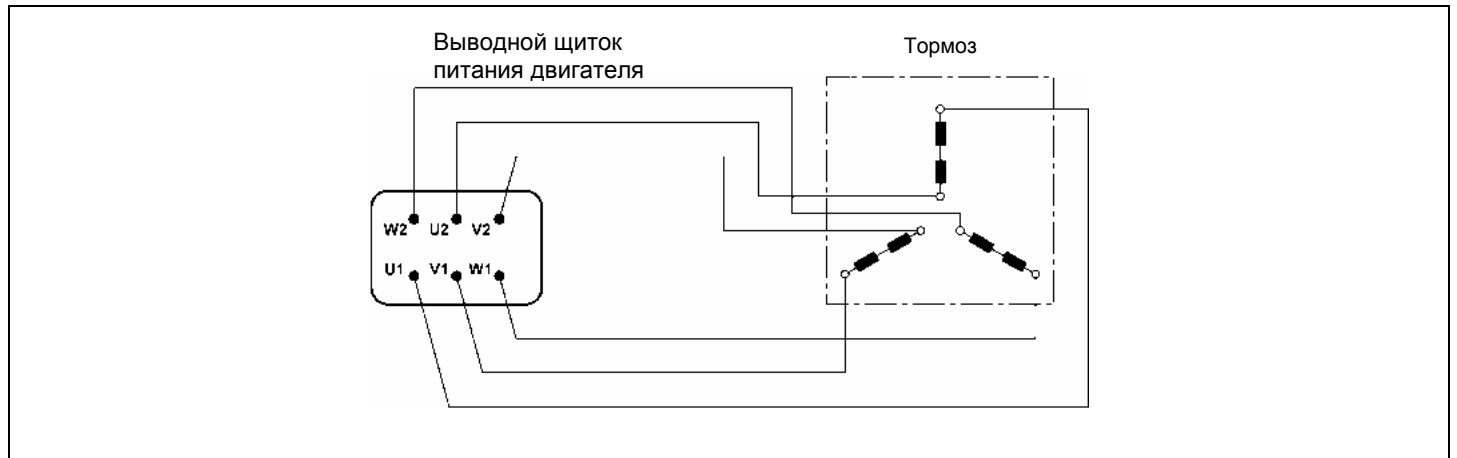

Двухскоростные и изготавливаемые по специальным заказам односкоростные электродвигатели с автономным питанием имеют в соединительной коробке дополнительный шестиконтактный выводной щиток электропитания тормоза. Электродвигатели таких модификаций оснащаются соединительными коробками большего размера. Подключение электропитания тормоза показано на схеме (68):

(А68)

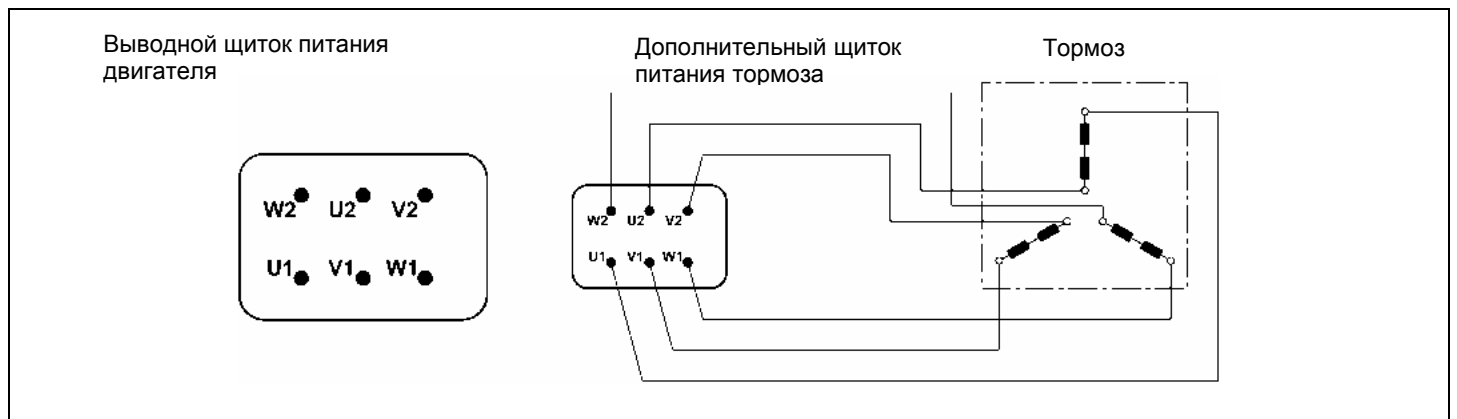

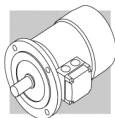

M9 - Системы разблокировки тормоза

Пружинные тормоза типа **FD** и **FA** по заказу оборудуются устройствами ручной разблокировки, которые используются для разблокировки тормоза электродвигателя вручную при проведении операций по обслуживанию и ремонту машин и механизмов, приводимых данным электродвигателем.

(A69)

R

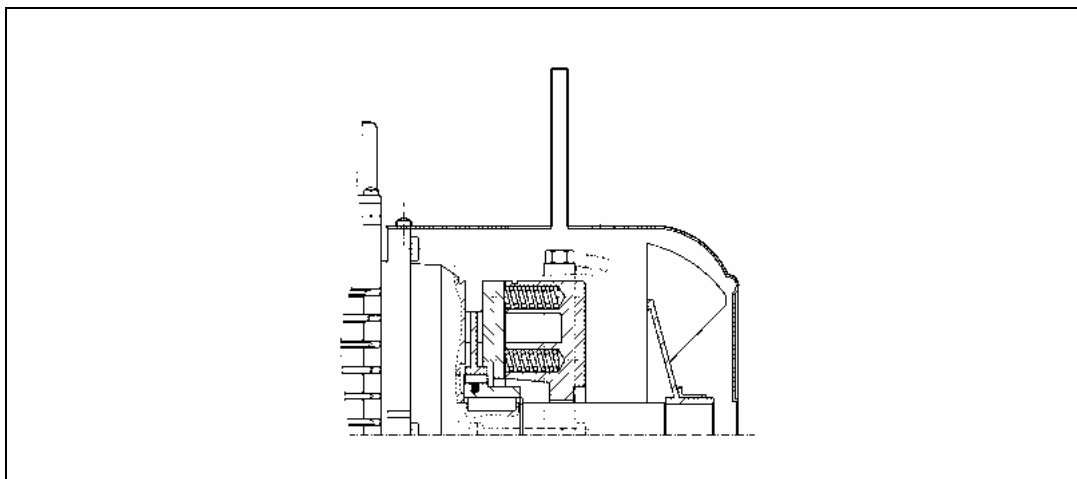

Рычаг возвращается в исходное положение возвратной пружиной.

(A70)

RM

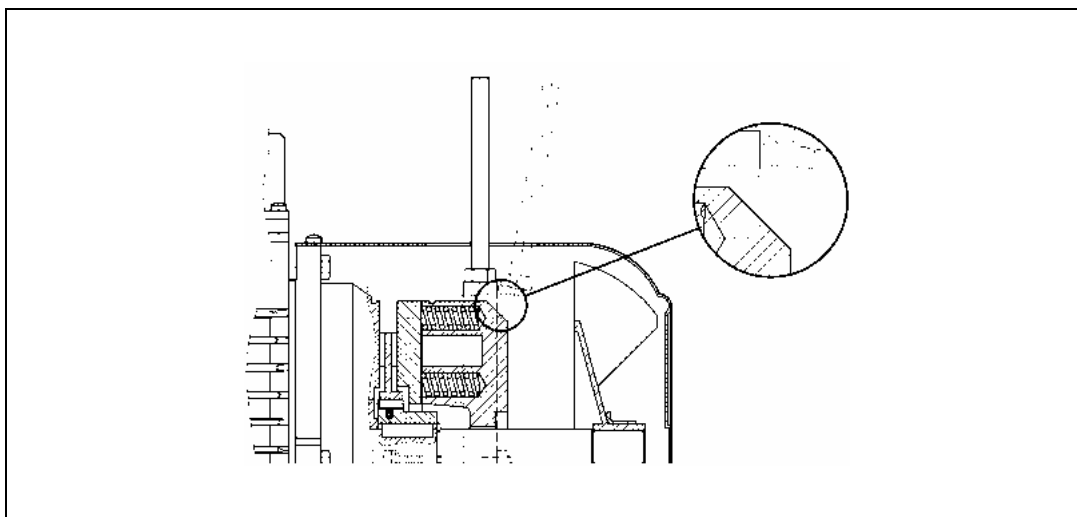

Для электродвигателей типа BN_FD рычаг ручной разблокировки тормоза фиксируется в положении «разблокировано» путем завинчивания рычага до его зацепления за выступ корпуса тормоза.
В ассортименте имеются различные системы разблокировки тормоза, предназначенные для различных типов двигателей (см. таблицу ниже):

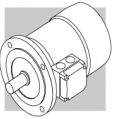

(A71)

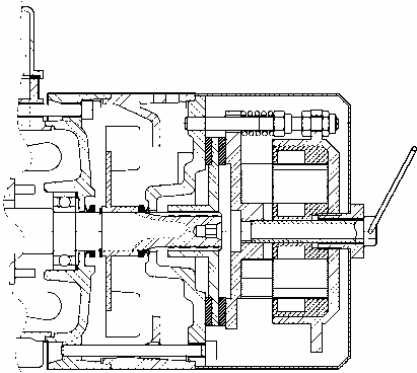
	R	RM
BN_FD	BN 63...BN 200	2p 63A2 ≤ H ≤ 132M2 4p 63A4 ≤ H ≤ 132MA4 6p 63A6 ≤ H ≤ 132MA6
M_FD	M 05...M 5	M 05...M 4LA
BN_FA	BN 63...BN 180M	
M_FA	M 05...M 5	
BN_BA	 <p>Стандартное исполнение</p>	

Расположение рычага разблокировки

В стандартном исполнении модификаций **R** и **RM** рычаг ручной разблокировки тормоза расположен под углом 90° по часовой стрелке к соединительной коробке (расположение, обозначенное на приведенной ниже схеме буквами [AB]). По специальному заказу возможно также исполнение данных модификаций с иным расположением рычага разблокировки (позиции [AA], [AC] и [AD]):

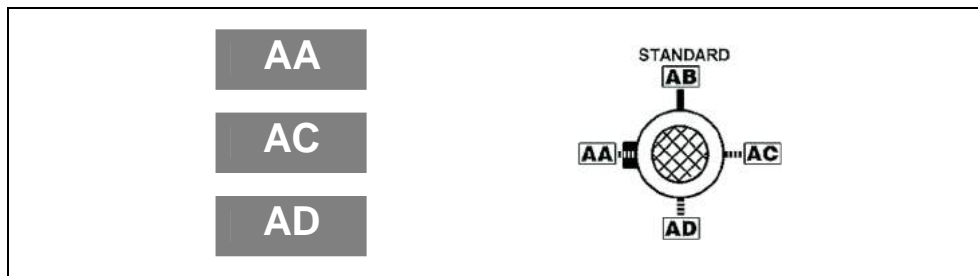

(A72)



Данные по маховичку (F1)

На нижеследующей таблице представлен вес и инерция маховичка (опция F1). Габаритные размеры электродвигателей остаются неизменными.

(A73)

		Вес маховичка [Кг]	Инерция маховичка [Кгм ²]
BN 63	M 05	0.69	0.00063
BN 71	M 1	1.13	0.00135
BN 80	M 2	1.67	0.00270
BN 90 S - BN 90 L	–	2.51	0.00530
BN 100	M 3	3.48	0.00840
BN 112	–	4.82	0.01483
BN 132 S - BN 132 M	M 4	6.19	0.02580

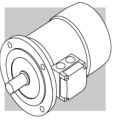

М10 - ОПЦИИ

Устройства термозащиты

Для дополнительной защиты обмоток от перегрева, вызванного недостаточной вентиляцией или работой с частыми запусками и остановками, стандартная система автоматического отключения может быть дополнена термистерами или термостатами. Оснащение такой дополнительной защитой особенно рекомендуется для двигателей с автономным охлаждением. Возможны следующие варианты дополнительной термозащиты:

E3

ТЕРМИСТОРЫ

3 термистора РТС (положительного температурного коэффициента), смонтированных в обмотках, температура срабатывания 150 °С

Термистором называется полупроводниковое устройство с быстро изменяющимся электрическим сопротивлением при достижении температуры срабатывания. Обычно используются термисторы положительного температурного коэффициента (РТС).

Преимуществами термисторных датчиков является малый размер, быстрое срабатывание и отсутствие износа в процессе эксплуатации. В отличие от биметаллических предохранителей, термисторы не имеют прямого выхода на реле и подключаются через разблокировки.

Контакты трех последовательно соединенных термисторов РТС выводятся на дополнительный выводной щиток.

D3

БИМЕТАЛЛИЧЕСКИЕ ПРЕДОХРАНИТЕЛИ

3 биметаллических предохранителя, смонтированных в обмотках, температура срабатывания 150°С

Биметаллический предохранитель состоит из биметаллического диска, помещенного в корпус. При достижении температуры срабатывания биметаллический диск размыкает электрическую цепь. При снижении температуры диск возвращается в исходное положение, снова замыкая электрическую цепь.

Обычно используются три последовательно соединенных предохранителя с нормально сомкнутым положением контактов с выходом на дополнительный выводной щиток.

H1

Нагреватели для предотвращения образования конденсата

При необходимости эксплуатации электродвигателя в условиях высокой влажности или значительных колебаний температур возможно оснащение двигателя противоконденсатным нагревателем. Питание нагревателя однофазное, выводы размещаются на дополнительном выходном щитке внутри основной соединительной коробки.

(A74)

		H1
		1~ 230В ± 10% P [Вт]
BN 56 ... BN 80	M0...M2	10
BN 90 ... BN 160MR	M3 – M4	25
BN 160M ... BN 180M	M5	50
BN 180L ... BN 200L	—	65

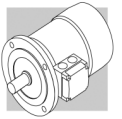

PS

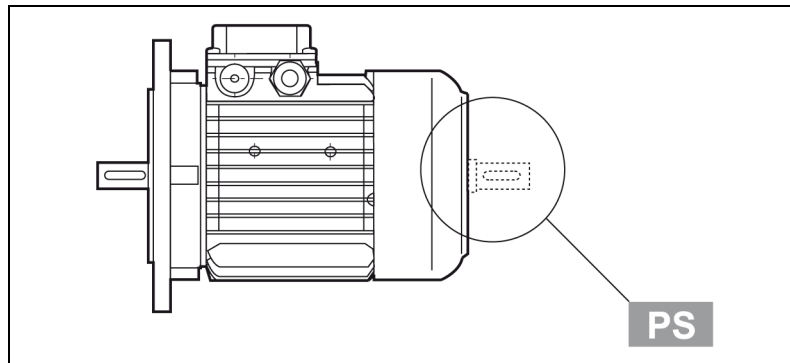

Двусторонний вал

Данная опция несовместима с вариантами исполнения RC, TC, U1, U2, EN1, EN2, EN3 – она также неприменима к электродвигателям, оснащенным тормозом BA.

Размеры вала см. в таблице размеров электродвигателей.

AL

AR

Стопор обратного хода

Электродвигатели со стопором обратного хода предназначены для применения в устройствах, где недопустимо вращение валов в обратном направлении – устройством оборудуются только двигатели серии M. Не препятствуя вращению вала в требуемом направлении, устройство срабатывает немедленно в случае отключения электропитания, предотвращая вращение вала в обратном направлении. Устройство смазывается специальной консистентной смазкой на весь период эксплуатации. При заказе необходимо указать требуемое направление вращения вала, AL «левое» или AR «правое». Не допускается применение устройства в целях предотвращения обратного хода вала, вызванного неправильным подключением. В таблице (A75) приведены номинальное и максимальное значение крутящего момента блокировки стопоров обратного хода. Схема устройства показана на рис (A76).

Общие размеры устройства, оборудованного устройством, аналогичны размерам соответствующего двигателя с тормозом.

(A75)

	Номинальный момент блокировки [Нм]	Макс. Момент блокировки [Нм]	Скорость разблокировки [мин ⁻¹]
M1	6	10	750
M2	16	27	650
M3	54	92	520
M4	110	205	430

(A76)

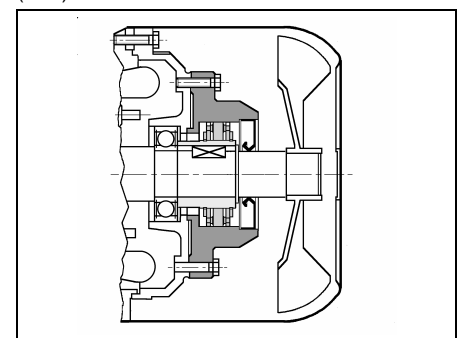

Охлаждение

Охлаждение электродвигателей осуществляется методом внешней вентиляции (IC 411 в соответствии со стандартом CEI EN 60034-6) посредством пластикового радиального вентилятора, работающего при любом направлении вращения.

В целях создания необходимых условий для беспрепятственной циркуляции воздуха при установке электродвигателя следует обеспечить некоторое удаление вентилятора от ближайшей стены, что также упрощает операции по обслуживанию электродвигателя и тормоза. По специальным заказам, электродвигатели типоразмеров BN 71 и выше, а также M1, охлаждаются системой принудительного охлаждения с автономным электропитанием. В этом случае охлаждение двигателя осуществляется при помощи вентилятора осевой вентиляции с автономным электропитанием (метод охлаждения IC 416). Данная опция позволяет увеличить коэффициент эксплуатации электродвигателя при его питании через инвертер и при работе на пониженных скоростях,

Опция неприменима к двигателям типа BN_VA и двигателям с двусторонним выходным валом (опция PS).

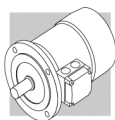

(A77)

Источник питания					
		Напряжение переменного тока $\pm 10\%$	Гц	P [W]	I [A]
BN 71	M1	1~ 230	50/60	22	0.14
BN 80	M2			22	0.14
BN 90	—			40	0.25
BN 100 (*)	M3			50	0.25
BN 112	—	3~ 230 Δ / 400Y		50	0.26 / 0.15
BN 132S	M4S		110	0.38 / 0.22	
BN 132M...BN 160MR	M4L				
BN 160...BN 180M	M5		50	180	1.25 / 0.72

В ассортименте имеются 2 варианта исполнения, **U1** и **U2**, при одинаковой общей длине электродвигателя. Максимальная длина кожуха вентилятора (ΔL) для каждой модификации приведена в следующей таблице. Данные об остальных размерах электродвигателя приведены в таблицах размеров электродвигателя.

(A78)

Удлинение электродвигателя при оснащении системой принудительной вентиляции			
		ΔL_1	ΔL_2
BN 71	M1	93	32
BN 80	M2	127	55
BN 90	—	131	48
BN 100	M3	119	28
BN 112	—	130	31
BN 132S	M4S	161	51
BN 132M	M4L	161	51

ΔL_1 = разница в размере по сравнению с длиной LB соответствующего электродвигателя в стандартном исполнении
 ΔL_2 = разница в размере по сравнению с длиной LB соответствующего электродвигателя с тормозом

U1



Выводы двигателя автономного вентилятора размещены в отдельно клеммной коробке. При этом в электродвигателях размеров BN 71...BN 160MR, варианта исполнения U1, рычаг ручной разблокировки тормоза не может быть расположен в положении AA.

Опция неприменима к двигателям, изготовленным в соответствии с нормами CSA и UL (опция CUS).



U2



Выводы двигателя автономного вентилятора размещены в клеммной коробке двигателя.

Данная опция не применяется к электродвигателям размеров BN 160 - BN 200L, за исключением BN 160MR, и для электродвигателей, изготовленных в соответствии с нормами CSA и UL (опция CUS).

(A79)

(*)			В пер/тока $\pm 10\%$	Гц	P [W]	I [A]
	BN 100_U2	M3	3~ 230 Δ / 400Y	50 / 60	40	0.24 / 0.14

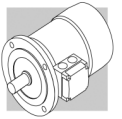

RC

Защитный колпак

Защитный колпак предназначен для защиты электродвигателя от атмосферных осадков и проникновения внутрь корпуса твердых частиц. Оснащение защитным колпаком рекомендуется в случае установки двигателя в вертикальном положении хвостовиком вала вниз.

Размеры колпака указаны в таблице (A80). Защитным колпаком не могут быть оснащены электродвигатели с двусторонним валом привода, двигатели PS, EN1, EN2, EN3 и также двигатели с ВА тормозом.

(A80)

		AQ	ΔV	
BN 63	M05	118	24	
BN 71	M1	134	27	
BN 80	M2	152	25	
BN 90	—	168	30	
BN 100	M3	190	28	
BN 112	—	211	32	
BN 132...BN	M4	254	32	
BN 160M...BN	M5	302	36	
BN 180L...BN 200L	—	340	36	

TC

Защитный колпак для текстильной промышленности

Исполнение TC является вариантом исполнения электродвигателя с защитным колпаком, предназначенным для применения в текстильной промышленности, где вентиляция двигателя может нарушаться из-за засорения решетки вентилятора ворсом. Данная опция неприменима к электродвигателям EN1, EN2, EN3, и двигателям, оборудованным ВА тормозом. Размеры аналогичны размерам защитного колпака типа RC.

Устройства обратной связи

Для создания схем обратной связи электродвигатели могут быть оснащены энкодерами трех различных типов. Электродвигатели с двусторонним валом (PS) двигатели, оснащенные колпаком для защиты от воздействия атмосферных осадков (RC, TC) также двигатели с тормозом ВА энкодерами не оборудуются.

EN1

Инкрементный энкодер, напряжение на входе 5 В, выход на линейный усилитель RS 422.

EN2

Инкрементный энкодер, напряжение на входе 10 – 30 В, выход на линейный усилитель RS 422.

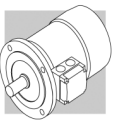

EN3

Инкрементный энкодер, напряжение на входе 12 – 30 В, двухтактный выход 12 – 30 В.

(A81)

	EN1	EN2	EN3
Интерфейс	RS 422	RS 422	push-pull
Напряжение питания [В]	4...6	10...30	12...30
Напряжение на выходе [В]	5	5	12...30
Рабочая сила тока без нагрузки [мА]	120	100	100
Число импульсов на оборот	1024		
Число сигналов	6 (А, В, С + обратные сигналы)		
Максимальная частота на выходе	300	300	200
Максимальная скорость вращения [мин ⁻¹]	6000 об/мин в течение 10 с		
Диапазон температур [°С]	-20...+70		
Степень защиты	IP 65		

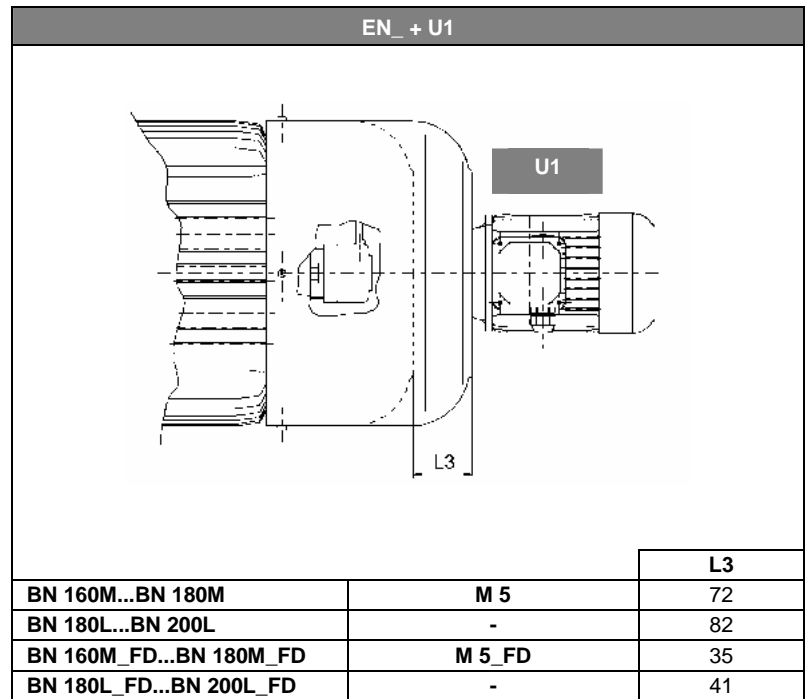
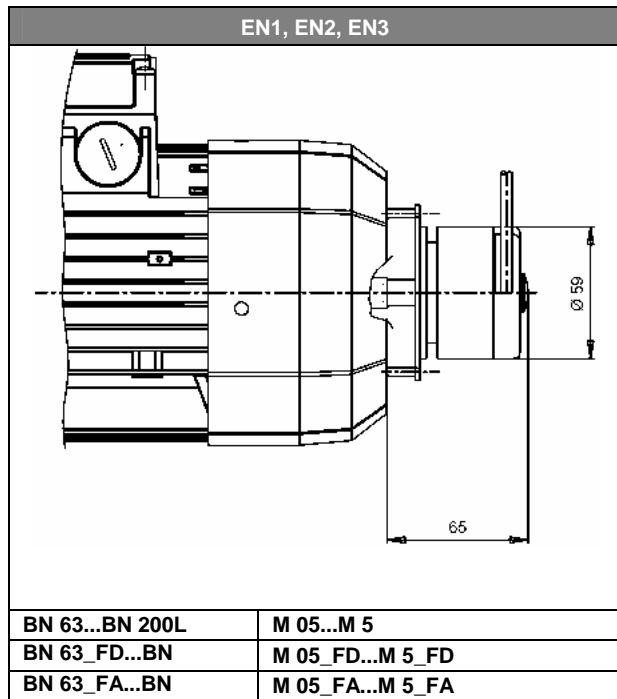

При наличии энкодера (опции EN1, EN2, EN3) на моторах BN71...BN160MR и M1...M4, вместе с опцией принудительного охлаждения (опции U1, U2), увеличение длины двигателя совпадает с соответствующими вариантами исполнения U1 и U2.

Pn kW		n МИН ⁻¹	Mn HM	EFF2	η (100%) %	η (75%) %	cos ϕ	In [400В] A	$\frac{I_s}{I_n}$	$\frac{M_s}{M_n}$	$\frac{M_a}{M_n}$	$\frac{J_m}{K_m^2}$	IM B5 $\frac{Q}{Kg}$	Тормоз пост/ток				Тормоз пер/ток													
														FD		FA		BA		FA		BA									
														Mod.	Mb HM	Z ₀ 1/h	SB	IM B5 $\frac{Q}{Kg}$	Mod.	Mb HM	Z ₀ 1/h	IM B5 $\frac{Q}{Kg}$	Mod.	Mb HM	Z ₀ 1/h	$\frac{J_m}{K_m^2}$	IM B5 $\frac{Q}{Kg}$				
0.18	BN 63A	2 2730	0.63		59.9	56.9	0.77	0.56	3.0	2.1	2	2.0	3.5	FD 02	1.75	3900	4800	2.6	5.2	FA 02	1.75	4800	4800	2.6	5.0	BA 60	5	3500	4.0	5.8	
0.25	BN 63B	2 2740	0.87		66.0	64.8	0.76	0.72	3.3	2.3	2.3	2.3	3.9	FD 02	1.75	3900	4800	3.0	5.6	FA 02	1.75	4800	4800	3.0	5.4	BA 60	5	3600	4.3	6.2	
0.37	BN 63C	2 2800	1.26		69.1	66.8	0.78	0.99	3.9	2.6	2.6	3.3	5.1	FD 02	3.5	3600	4500	3.9	6.8	FA 02	3.5	4500	4500	3.9	6.6	BA 60	5	3500	5.3	7.4	
0.37	BN 71A	2 2820	1.25		73.8	73.0	0.76	0.95	4.8	2.8	2.6	3.5	5.4	FD 03	3.5	3000	4100	4.6	8.1	FA 03	3.5	4200	4200	4.6	7.8	BA 70	8	3500	5.5	9.3	
0.55	BN 71B	2 2820	1.86		76.0	75.8	0.76	1.37	5.0	2.9	2.8	4.1	6.2	FD 03	5	2900	4200	5.3	8.9	FA 03	5	4200	4200	5.3	8.6	BA 70	8	3600	6.1	10.1	
0.75	BN 71C	2 2810	2.6		76.6	76.2	0.76	1.86	5.1	3.1	2.8	5.0	7.3	FD 03	5	1900	3300	6.1	10	FA 03	5	3600	3600	6.1	9.7	BA 70	8	3200	7.0	11.2	
0.75	BN 80A	2 2810	2.6		76.2	75.5	0.81	1.75	4.8	2.6	2.2	7.8	8.6	FD 04	5	1700	3200	9.4	12.5	FA 04	5	3200	3200	9.4	12.4	BA 80	18	2800	10.8	13.9	
1.1	BN 80B	2 2800	3.8	EFF2	76.4	76.2	0.81	2.57	4.8	2.8	2.4	9.0	9.5	FD 04	10	1500	3000	10.6	13.4	FA 04	10	3000	3000	10.6	13.3	BA 80	18	2700	12.0	14.8	
1.5	BN 80C	2 2800	5.1	EFF2	79.1	79.5	0.81	3.4	4.9	2.7	2.4	11.4	11.3	FD 04	15	1300	2600	13.0	15.2	FA 04	15	2600	2600	13.0	15.1	BA 80	18	2400	14.4	16.6	
1.5	BN 90SA	2 2870	5.0	EFF2	82.0	81.5	0.80	3.3	5.9	2.7	2.6	12.5	12.3	FD 14	15	900	2200	14.1	16.5	FA 14	15	2200	2200	14.1	16.4	BA 90	35	1600	19.5	19.6	
1.85	BN 90SB	2 2880	6.1	EFF2	82.5	82.0	0.80	4.0	6.2	2.9	2.6	16.7	14	FD 14	15	900	2200	18.3	18.2	FA 14	15	2200	2200	18.3	18.1	BA 90	35	1700	23.7	21.3	
2.2	BN 90L	2 2880	7.3	EFF2	82.7	82.1	0.80	4.8	6.3	2.9	2.7	16.7	14	FD 05	26	900	2200	21	20	FA 05	26	2200	2200	21	20.7	BA 90	35	1700	24	21.3	
3	BN 100L	2 2860	10.0	EFF2	82.8	82.6	0.79	6.6	5.7	2.6	2.2	31	20	FD 15	26	700	1600	35	26	FA 15	26	1600	1600	35	27	BA 100	50	1300	43	30	
4	BN 100LB	2 2870	13.3	EFF2	84.3	84.4	0.80	8.6	5.9	2.7	2.5	39	23	FD 15	40	450	900	43	29	FA 15	40	1000	1000	43	30	BA 100	50	850	51	33	
4	BN 112M	2 2900	13.2	EFF2	85.5	84.5	0.82	8.2	6.9	3	2.9	57	28	FD 06S	40	—	950	66	39	FA 06S	40	950	950	66	40	BA 110	75	850	73	41	
5.5	BN 132SA	2 2890	18.2	EFF2	86.1	85.7	0.84	11.0	6	2.6	2.2	101	35	FD 06	50	—	600	112	48	FA 06	50	600	600	112	49	BA 140	150	500	151	67	
7.5	BN 132SB	2 2900	25	EFF2	87.2	87.1	0.85	14.6	6.4	2.6	2.2	145	42	FD 06	50	—	550	154	55	FA 06	50	550	550	154	56	BA 140	150	450	195	74	
9.2	BN 132M	2 2930	30	EFF2	89.0	88.5	0.86	17.3	6.9	2.8	2.3	178	53	FD 56	75	—	430	189	66	FA 06	75	430	430	189	67	BA 140	150	400	228	85	
11	BN 160MR	2 2920	36	EFF2	89.1	88.9	0.88	20.2	7.0	2.9	2.5	210	65																		
15	BN 160MB	2 2930	49	EFF2	89.6	89.4	0.86	28.1	7.1	2.6	2.3	340	84																		
18.5	BN 160L	2 2930	60	EFF2	90.4	90.1	0.86	34	7.6	2.7	2.3	420	97																		
22	BN 180M	2 2930	72	EFF2	91.3	91.3	0.88	40	7.8	2.6	2.4	490	109																		
30	BN 200LA	2 2930	98	EFF2	91.9	91.4	0.89	53	7.9	2.7	2.9	770	140																		

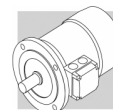

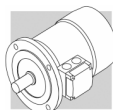











4 P

1500 МИН⁻¹ - S1

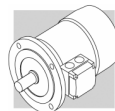
50 Hz

Pn kW		n МИН ⁻¹	Mn HM		η (100%) %	η (75%) %	cos φ	In [400В] А	Is In	$\frac{M_s}{M_n}$ Mn	$\frac{M_s}{M_n}$ Mn	$\frac{J_m}{K_{nm}^2}$ Knm ²	IM B5  Kg	ТОРМОЗ ПОСТ/ТОК. FD				ТОРМОЗ ПЕР/ТОК. FA				ТОРМОЗ ПЕР/ТОК. BA										
														Mod.	HM	NB	SB	$\frac{J_m}{K_{nm}^2}$ Knm ²	IM B5  Kg	Mod.	HM	1/h	$\frac{J_m}{K_{nm}^2}$ Knm ²	IM B5  Kg	Mod.	HM	1/h	$\frac{J_m}{K_{nm}^2}$ Knm ²	Mb max HM	Z ₀	$\frac{J_m}{K_{nm}^2}$ Knm ²	IM B5  Kg
0.06	BN 56A	4	1340	0.43	46.8	44.2	0.65	0.28	2.6	2.3	2.0	1.5	3.1	FD 02	1.75	10000	13000	2.6	5.2	FA 02	1.75	13000	2.6	5.0	BA 60	5	9000	4.0	5.8			
0.09	BN 56B	4	1350	0.64	51.7	47.6	0.60	0.42	2.6	2.5	2.4	1.5	3.1	FD 02	3.5	10000	13000	3.0	5.6	FA 02	3.5	13000	3.0	5.4	BA 60	5	9000	4.3	6.2			
0.12	BN 63A	4	1350	0.85	59.8	56.2	0.62	0.47	2.6	1.9	1.8	2.0	3.5	FD 02	3.5	7800	10000	3.9	6.8	FA 02	3.5	10000	3.9	6.6	BA 60	5	8500	5.3	7.4			
0.18	BN 63B	4	1320	1.30	54.8	52.9	0.67	0.71	2.6	2.2	2.0	2.3	3.9	FD 03	3.5	6000	9400	8.0	8.6	FA 03	5.0	9400	8.0	8.3	BA 70	8	8500	8.9	9.8			
0.25	BN 63C	4	1340	1.78	65.3	65.0	0.69	0.80	2.7	2.1	1.9	3.3	5.1	FD 53	7.5	4300	8700	10.2	10	FA 03	7.5	8700	10.2	9.7	BA 70	8	8000	11.1	11.2			
0.25	BN 71A	4	1380	1.73	63.7	62.2	0.73	0.78	3.3	1.9	1.7	5.8	5.1	FD 03	3.5	7700	11000	6.9	7.8	FA 03	3.5	11000	6.9	7.5	BA 70	8	9700	7.8	9.0			
0.37	BN 71B	4	1370	2.6	66.8	66.7	0.76	1.05	3.7	2.0	1.9	6.9	5.9	FD 03	5.0	6000	9400	8.0	8.6	FA 03	5.0	9400	8.0	8.3	BA 70	8	8500	8.9	9.8			
0.55	BN 71C	4	1380	3.8	69.0	68.9	0.74	1.55	4.1	2.3	2.3	9.1	7.3	FD 04	15	2600	5300	27	15.2	FA 04	15	5300	27	15.1	BA 80	18	5100	28	16.6			
0.55	BN 80A	4	1390	3.8	72.0	71.3	0.77	1.43	4.1	2.3	2.0	15	8.2	FD 04	10	4100	8000	16.6	12.1	FA 04	10	8000	16.6	12.0	BA 80	18	7400	18	13.5			
0.75	BN 80B	4	1400	5.1	75.0	74.5	0.78	1.85	4.9	2.7	2.5	20	9.9	FD 04	15	4100	7800	22	13.8	FA 04	15	7800	22	13.7	BA 80	18	7400	23	15.2			
1.1	BN 80C	4	1400	7.5	76.4	76.2	0.78	2.66	5.1	2.8	2.5	25	11.3	FD 04	15	2600	5300	27	15.2	FA 04	15	5300	27	15.1	BA 80	18	5100	28	16.6			
1.1	BN 90S	4	1400	7.5	76.5	76.2	0.77	2.70	4.6	2.6	2.2	21	12.2	FD 14	15	4800	8000	23	16.4	FA 14	15	8000	23	16.3	BA 90	35	6500	28	19.5			
1.5	BN 90LA	4	1390	10.3	78.7	78.5	0.77	3.6	5.3	2.8	2.4	28	13.6	FD 05	26	3400	6000	32	19.6	FA 05	26	6000	32	20.3	BA 90	35	5400	35	21			
1.85	BN 90LB	4	1390	12.7	81.0	81.4	0.78	4.2	5.2	2.8	2.6	30	15.1	FD 05	26	3200	5900	34	21.1	FA 05	26	5900	34	21.8	BA 90	35	5400	37	22.5			
2.2	BN 100LA	4	1410	14.9	81.1	81.4	0.75	5.2	4.5	2.2	2.0	40	18.3	FD 15	40	2600	4700	44	25	FA 15	40	4700	44	25	BA 100	50	4000	52	29			
3	BN 100LB	4	1410	20	82.6	83.8	0.77	6.8	5	2.3	2.2	54	22	FD 15	40	2400	4400	58	28	FA 15	40	4400	58	29	BA 100	50	3800	66	32			
4	BN 112M	4	1430	27	84.4	84.2	0.81	8.4	5.6	2.7	2.5	98	30	FD 06S	60	—	1400	107	40	40	FA 06S	60	2100	107	42	BA 110	75	2000	114	43		
5.5	BN 132S	4	1440	36	86.3	86.4	0.80	11.5	5.5	2.3	2.2	213	44	FD 56	75	—	1050	223	57	57	FA 06	75	1200	223	58	BA 140	150	1200	263	76		
7.5	BN 132MA	4	1440	50	87.0	87.1	0.80	15.6	5.7	2.5	2.4	270	53	FD 06	100	—	950	280	66	66	FA 07	100	1000	280	71	BA 140	150	1000	320	85		
9.2	BN 132MB	4	1440	61	88.4	88.6	0.80	18.8	5.9	2.7	2.5	319	59	FD 07	150	—	900	342	75	75	FA 07	150	900	342	77	BA 140	150	900	369	91		
11	BN 160MIR	4	1440	73	88.4	88.8	0.81	22.2	5.9	2.7	2.5	360	70	FD 07	150	—	850	382	86	86	FA 07	150	850	382	88							
15	BN 160L	4	1460	98	89.9	89.4	0.81	29.7	5.9	2.3	2.1	650	99	FD 08	200	—	750	725	129	129	FA 08	200	750	710	128							
18.5	BN 180M	4	1460	121	90.0	90.1	0.81	37	6.2	2.6	2.5	790	115	FD 08	250	—	700	865	145	144	FA 08	250	700	850	144							
22	BN 180L	4	1460	144	90.7	91.1	0.81	43	6.5	2.5	2.5	1250	135	FD 09	300	—	400	1450	175	175	FA 09	300	400	1450	175							
30	BN 200L	4	1460	196	91.4	91.7	0.80	59	7.1	2.7	2.8	1650	157	FD 09	400	—	300	1850	197	197	FA 09	400	300	1850	197							





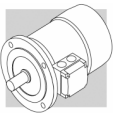

Pn kW		n МИН ⁻¹	Mn Нм	η %	cos φ	In [400В] А	Is In	Ms Мн	Ma Мн	Jm x10 ⁻⁴ Кгм ²	IM B5 	Тормоз пост/ток				Тормоз пер/ток											
												Mod.	Mb Нм	Zo 1/h	SB	IM B5 	Jm x10 ⁻⁴ Кгм ²	Zo 1/h	Mb Нм	Mod.	Mb max Нм	Zo 1/h	Jm x10 ⁻⁴ Кгм ²	IM B5 			
0.09	BN 63A	6	0.98	41	0.53	0.60	2.1	2.1	1.8	3.4	4.6	FD 02	3.5	9000	14000	4.0	6.3	FA 02	3.5	14000	4.0	6.1	BA 60	5	12000	5.4	6.9
0.12	BN 63B	6	1.32	45	0.60	0.64	2.1	1.9	1.7	3.7	4.9	FD 02	3.5	9000	14000	4.3	6.6	FA 02	3.5	14000	4.3	6.4	BA 60	5	12000	5.7	7.2
0.18	BN 71A	6	1.91	56	0.69	0.67	2.6	1.9	1.7	8.4	5.5	FD 03	5.0	8100	13500	9.5	8.2	FA 03	5.0	13500	9.5	7.9	BA 70	8	12300	10.4	9.4
0.25	BN 71B	6	2.7	62	0.71	0.82	2.6	1.9	1.7	10.9	6.7	FD 03	5.0	7800	13000	12	9.4	FA 03	5.0	13000	12	9.1	BA 70	8	12000	12.9	10.6
0.37	BN 71C	6	3.9	66	0.69	1.17	3	2.4	2.0	12.9	7.7	FD 53	7.5	5100	9500	14	10.4	FA 03	7.5	9500	14	10.1	BA 70	8	8900	14.9	11.6
0.37	BN 80A	6	3.9	68	0.68	1.15	3.2	2.2	2.0	21	9.9	FD 04	10	5200	8500	23	13.8	FA 04	10	8500	23	13.7	BA 80	18	8000	24	15.2
0.55	BN 80B	6	5.7	70	0.69	1.64	3.9	2.6	2.2	25	11.3	FD 04	15	4800	7200	27	15.2	FA 04	15	7200	27	15.1	BA 80	18	6800	28	16.6
0.75	BN 80C	6	7.8	70	0.65	2.38	3.8	2.5	2.2	28	12.2	FD 04	15	3400	6400	30	16.1	FA 04	15	6400	30	16.0	BA 80	18	6100	31	17.5
0.75	BN 90S	6	7.8	69	0.68	2.31	3.8	2.4	2.2	26	12.6	FD 14	15	3400	6500	28	16.8	FA 14	15	6500	28	16.7	BA 90	35	5500	33	19.9
1.1	BN 90L	6	11.4	72	0.69	3.2	3.9	2.3	2.0	33	15	FD 05	26	2700	5000	37	21	FA 05	26	5000	37	22	BA 90	35	4600	40	22
1.5	BN 100LA	6	15.2	73	0.72	4.1	4	2.1	2.0	82	22	FD 15	40	1900	4100	86	28	FA 15	40	4100	86	29	BA 100	50	3800	94	32
1.85	BN 100LB	6	19.0	75	0.73	4.9	4.5	2.1	2.0	95	24	FD 15	40	1700	3600	99	30	FA 15	40	3600	99	31	BA 100	50	3400	107	34
2.2	BN 112M	6	22	78	0.73	5.6	4.8	2.2	2.0	168	32	FD 06S	60	—	2100	177	42	FA 06S	60	2100	177	44	BA 110	75	2000	184	45
3	BN 132S	6	30	76	0.76	7.5	4.8	1.9	1.8	216	36	FD 56	75	—	1400	226	49	FA 06	75	1400	226	50	BA 140	150	1200	266	68
4	BN 132MA	6	40	78	0.77	9.6	5.5	2.0	1.8	295	45	FD 06	100	—	1200	305	58	FA 07	100	1200	318	63	BA 140	150	1050	345	77
5.5	BN 132MB	6	56	80	0.78	12.7	5.9	2.1	1.9	383	56	FD 07	150	—	1050	406	72	FA 07	150	1050	406	74	BA 140	150	1000	433	88
7.5	BN 160M	6	75	84	0.81	15.9	5.9	2.2	2.0	740	83	FD 08	170	—	900	815	112	FA 08	170	900	815	113					
11	BN 160L	6	109	87	0.81	22.5	6.5	2.5	2.3	970	103	FD 08	200	—	800	1045	133	FA 08	200	800	1045	133					
15	BN 180L	6	148	88	0.82	30	6.2	2.0	2.4	1550	130	FD 09	300	—	600	1750	170										
18.5	BN 200LA	6	184	88	0.81	37	5.9	2.0	2.3	1700	145	FD 09	400	—	450	1900	185										







2/4 P

3000/1500 МИН⁻¹ - S1

50 Hz

Pn kW		n МИН ⁻¹	Mn Нм	η %	cos φ	In [400В] А	Is In	MS Mn	MA Mn	Jm x10 ⁻⁴ Кгм ²	IM B5 	ТОРМОЗ ПОСТ/ТОК						ТОРМОЗ ПЕР/ТОК											
												FD			FA			BA			FD			FA			BA		
												Mod.	Mb Нм	Z ₀ 1/н NB SB	Jm x10 ⁻⁴ Кгм ²	IM B5 	Mod.	Mb Нм	Z ₀ 1/н	Jm x10 ⁻⁴ Кгм ²	IM B5 	Mod.	Mb Нм	Z ₀ 1/н	Jm x10 ⁻⁴ Кгм ²	IM B5 	Mod.	Mb Нм	Z ₀ 1/н
0.20	BN 63B	2 2700	0.71	55	0.82	0.64	3.5	2.1	1.9	2.9	4.4	FD 02	3.5	2200	2600	3.5	6.1	FA 02	3.5	2600	5100	3.5	5.9	BA 60	5	2000	4.9	6.7	
0.15		4 1350	1.06	49	0.67	0.66	2.6	1.8	1.7			4000	5100												4000				
0.28	BN 71A	2 2700	0.99	56	0.82	0.88	2.9	1.9	1.7	4.7	4.4	FD 03	3.5	2100	2400	5.8	7.1	FA 03	3.5	2400	4800	5.8	6.8	BA 70	8	2100	5.6	8.3	
0.20		4 1370	1.39	59	0.72	0.68	3.1	1.8	1.7			3800	4800												4200				
0.37	BN 71B	2 2740	1.29	56	0.82	1.16	3.5	1.8	1.8	5.8	5.1	FD 03	5	1400	2100	6.9	7.8	FA 03	5	2100	4200	6.9	7.5	BA 70	8	1800	7.8	9.0	
0.25		4 1390	1.72	60	0.73	0.82	3.3	2.0	1.9			2900	4200												3600				
0.45	BN 71C	2 2780	1.55	63	0.85	1.21	3.8	1.8	1.8	6.9	5.9	FD 03	5	1400	2100	8.0	8.6	FA 03	5	2100	4200	8.0	8.3	BA 70	8	1800	8.9	9.8	
0.30		4 1400	2.0	63	0.73	0.94	3.6	2.0	1.9			2900	4200												3600				
0.55	BN 80A	2 2800	1.9	63	0.85	1.48	3.9	1.7	1.7	15	8.2	FD 04	5	1600	2300	16.6	12.1	FA 04	5	2300	4000	16.6	12.0	BA 80	18	2100	18	13.5	
0.37		4 1400	2.5	67	0.79	1.01	4.1	1.8	1.9			3000	4000												3700				
0.75	BN 80B	2 2780	2.6	65	0.85	1.96	3.8	1.9	1.8	20	9.9	FD 04	10	1400	1600	22	13.8	FA 04	10	1600	3600	22	13.7	BA 80	18	1500	22	15.2	
0.55		4 1400	3.8	68	0.81	1.44	3.9	1.7	1.7			2700	3600												3300				
1.1	BN 90S	2 2790	3.8	71	0.82	2.73	4.7	2.3	2.0	21	12.2	FD 14	10	1500	1600	23	16.4	FA 14	10	1600	2800	23	16.3	BA 90	35	1300	28	19.5	
0.75		4 1390	5.2	66	0.79	2.08	4.6	2.4	2.2			2300	2800												2300				
1.5	BN 90L	2 2780	5.2	70	0.85	3.64	4.5	2.4	2.1	28	14.0	FD 05	26	1050	1200	32	20	FA 05	26	1200	2000	32	21	BA 90	35	1100	35	21	
1.1		4 1390	7.6	73	0.81	2.69	4.7	2.5	2.2			1600	2000												1800				
2.2	BN 100LA	2 2800	7.5	72	0.85	5.2	4.5	2.0	1.9	40	18.3	FD 15	26	600	900	44	25	FA 15	26	900	2300	44	25	BA 100	50	750	51	29	
1.5		4 1410	10.2	73	0.79	3.8	4.7	2.0	2.0			1300	2300												1900				
3.5	BN 100LB	2 2850	11.7	80	0.84	7.5	5.4	2.2	2.1	61	25	FD 15	40	500	900	65	31	FA 15	40	900	2100	65	32	BA 100	50	750	72	35	
2.5		4 1420	16.8	82	0.80	5.5	5.2	2.2	2.2			1000	2100												1800				
4	BN 112M	2 2880	13.3	79	0.83	8.8	6.1	2.4	2.0	98	30	FD 06S	60	—	—	107	40	FA 06S	60	700	1200	107	42	BA 110	75	600	114	43	
3.3		4 1420	22.2	80	0.80	7.4	5.1	2.1	2.0			—	—	—	—	—	—	—	—	—	—	—	—	—	1100				
5.5	BN 132S	2 2890	18.2	80	0.87	11.4	5.9	2.4	2.0	213	44	FD 56	75	—	—	223	57	FA 06	75	350	900	223	58	BA 140	150	300	263	76	
4.4		4 1440	29	82	0.84	9.2	5.3	2.2	2.0			—	—	—	—	—	—	—	—	—	—	—	—	—	750				
7.5	BN 132MA	2 2900	25	82	0.87	15.2	6.5	2.4	2.0	270	53	FD 06	100	—	—	280	66	FA 07	100	350	900	280	71	BA 140	150	300	320	85	
6		4 1430	40	84	0.85	12.1	5.8	2.3	2.1			—	—	—	—	—	—	—	—	—	—	—	—	—	800				
9.2	BN 132MB	2 2920	30	83	0.86	18.6	6.0	2.6	2.2	319	59	FD 07	150	—	—	342	75	FA 07	150	300	800	342	77	BA 140	150	300	369	91	
7.3		4 1440	48	85	0.85	14.6	5.5	2.3	2.1			—	—	—	—	—	—	—	—	—	—	—	—	—	750				

Pn kW		n МИН ⁻¹	Mn Нм	η %	cos φ	In [400В] А	Is In	Ms Мп	Ma Мп	Jm x10 ⁻⁴ Клм ²	IM B5 	Тормоз пост/ток					Тормоз пер/ток																				
												Мод.	Mb Нм	Zo 1/h	NB	SB	Jm x10 ⁻⁴ Клм ²	IM B5 	Мод.	Mb Нм	Zo 1/h	Mb max Нм	Zo 1/h	Jm x10 ⁻⁴ Клм ²	IM B5 												
0.25	BN 71A	2 2850	0.84	60	0.82	0.73	4.3	1.9	1.8	6.9	5.9	FD 03	1.75	1500	1700	8.0	8.6	FA 03	2.5	1700	13000	8	1500	8.9	8.3	BA 70	8	1500	11000	8.9	8.9	BA 70	8	1500	11000	8.9	8.9
0.08		6 910	0.84	43	0.70	0.38	2.1	1.4	1.5				10000	13000		10.2	10.0		3.5	1300	11000	8	1200	11.1	9.7		8	1200	10000	11.1	11.1		8	1200	10000	11.1	11.1
0.37	BN 71B	2 2880	1.23	62	0.80	1.08	4.4	1.9	1.8	9.1	7.3	FD 03	3.5	1000	1300	10.2	10.0	FD 03	3.5	1300	11000	8	1200	11.1	9.7		8	1200	10000	11.1	11.1		8	1200	10000	11.1	11.1
0.12		6 900	1.27	44	0.73	0.54	2.4	1.4	1.5				9000	11000		22	13.8		5	1800	6300	5	1800	23	13.7		18	1700	6000	23	15.2		18	1700	6000	23	15.2
0.55	BN 80A	2 2800	1.88	63	0.86	1.47	4.5	1.9	1.7	20	9.9	FD 04	5	1500	1800	22	13.8	FD 04	5	1800	6300	5	1800	23	13.7		18	1700	6000	23	15.2		18	1700	6000	23	15.2
0.18		6 930	1.85	52	0.65	0.77	3.3	2	1.9				4100	6300		27	15.2		5	1900	6000	5	1900	28	15.1		18	1800	5600	28	16.6		18	1800	5600	28	16.6
0.75	BN 80B	2 2800	2.6	66	0.87	1.89	4.3	1.8	1.6	25	11.3	FD 04	5	1700	1900	27	15.2	FD 04	5	1900	6000	5	1900	28	15.1		18	1800	5600	28	16.6		18	1800	5600	28	16.6
0.25		6 930	2.6	54	0.67	1.00	3.2	1.7	1.8				3800	6000		32	20		13	1600	6000	13	1600	35	21		35	1500	4700	35	21		35	1500	4700	35	21
1.1	BN 90L	2 2860	3.7	67	0.84	2.82	4.7	2.1	1.9	28	14.0	FD 05	13	1400	1600	32	20	FD 05	13	1600	5200	13	1600	35	21		35	1500	4700	35	21		35	1500	4700	35	21
0.37		6 920	3.8	59	0.71	1.27	3.3	1.6	1.6				3400	5200		44	24		13	1200	4000	13	1200	51	25		50	1050	3500	51	29		50	1050	3500	51	29
1.5	BN 100LA	2 2880	5.0	73	0.84	3.53	5.1	1.9	2.0	40	18.3	FD 15	13	1000	1200	44	24	FD 15	13	1200	4000	13	1200	51	25		50	1050	3500	51	29		50	1050	3500	51	29
0.55		6 940	5.6	64	0.67	1.85	3.5	1.7	1.8				2900	4000		65	31		26	900	3000	26	900	72	32		72	800	2700	72	36		72	800	2700	72	36
2.2	BN 100LB	2 2900	7.2	77	0.85	4.9	5.9	2.0	2.0	61	25	FD 15	26	700	900	65	31	FD 15	26	900	3000	26	900	72	32		72	800	2700	72	36		72	800	2700	72	36
0.75		6 950	7.5	67	0.64	2.5	3.3	1.9	1.8				2100	3000		65	31		40	1000	3000	40	1000	85	32		85	930	2400	85	43		85	930	2400	85	43
3	BN 112M	2 2900	9.9	78	0.87	6.4	6.3	2.0	2.1	98	30	FD 06S	40	—	1000	107	107	40	FA 06S	40	1000	2600	40	1000	114	32		75	930	114	43		75	930	114	43	
1.1		6 950	11.1	72	0.64	3.4	3.9	1.8	1.8				—	2600		107	40		40	2600		40	2600	114	32		75	930	114	43		75	930	114	43		
4.5	BN 132S	2 2910	14.8	78	0.84	9.9	5.8	1.9	1.8	213	44	FD 56	37	—	500	223	223	57	FA 06	37	500	2100	37	500	263	58		150	400	263	76		150	400	263	76	
1.5		6 960	14.9	74	0.67	4.4	4.2	1.9	2.0				—	2100		223	57		37	2100		37	2100	263	58		150	400	263	76		150	400	263	76		
5.5	BN 132M	2 2920	18.0	78	0.87	11.7	6.2	2.1	1.9	270	53	FD 56	50	—	400	280	280	66	FA 06	50	400	1900	50	400	320	67		150	350	320	85		150	350	320	85	
2.2		6 960	22	77	0.71	5.8	4.3	2.1	2.0				—	1900		280	66		50	1900		50	1900	320	67		150	350	320	85		150	350	320	85		

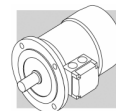

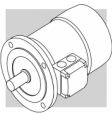











2/8 P

3000/750 МИН⁻¹ - S3 60/40%

50 Hz

Pn kW		n МИН ⁻¹	Mn Нм	η %	cos φ	In [400В] А	Is In	MS Mn	MA Mn	Jm x10 ⁻⁴ Кгм ²	IM B5 	ТОРМОЗ ПОСТ/ТОК				ТОРМОЗ ПЕР/ТОК															
												Мод.	Mb Нм	Z _c 1/н	Jm x10 ⁻⁴ Кгм ²	IM B5 	Мод.	Mb Нм	Z _c 1/н	Jm x10 ⁻⁴ Кгм ²	IM B5 	Мод.	Mb Нм	Z _c 1/н	Jm x10 ⁻⁴ Кгм ²	IM B5 					
0.25	BN 71A	2 2790	0.86	61	0.87	0.68	3.9	1.8	1.9	10.9	6.7	FD 03	1.75	1300	1400	12	9.4	FA 03	2.5	1400	13000	12	9.1	BA 70	8	1300	12000	12.9	10.6		
0.06		8 680	0.84	31	0.61	0.46	2	1.8	1.9				10000	13000																	
0.37	BN 71B	2 2800	1.26	63	0.86	0.99	3.9	1.8	1.9	12.9	7.7	FD 03	3.5	1200	1300	14	10.4	FA 03	3.5	1300	13000	14	10.1	BA 70	8	1200	12000	14.9	11.6		
0.09		8 670	1.28	34	0.75	0.51	1.8	1.4	1.5				9500	13000																	
0.55	BN 80A	2 2830	1.86	66	0.86	1.40	4.4	2.1	2.0	20	9.9	FD 04	5	1500	1800	22	13.8	FA 04	5	1800	8000	22	13.7	BA 80	18	1700	7500	23	15.2		
0.13		8 690	1.80	41	0.64	0.72	2.3	1.6	1.7				5600	8000																	
0.75	BN 80B	2 2800	2.6	68	0.88	1.81	4.6	2.1	2.0	25	11.3	FD 04	10	1700	1900	27	15.2	FA 04	10	1900	7300	27	15.1	BA 80	18	1800	7000	28	16.6		
0.18		8 690	2.5	43	0.66	0.92	2.3	1.6	1.7				4800	7300																	
1.1	BN 90L	2 2830	3.7	63	0.84	3.00	4.5	2.1	1.9	28	14	FD 05	13	1400	1600	32	20	FA 05	13	1600	5100	32	21	BA 90	35	1400	4500	35	21		
0.28		8 690	3.9	48	0.63	1.34	2.4	1.8	1.9				3400	5100																	
1.5	BN 100LA	2 2880	5.0	69	0.85	3.69	4.7	1.9	1.8	40	18.3	FD 15	13	1000	1200	44	25	FA 15	13	1200	5000	44	25	BA 100	50	1000	4200	52	29		
0.37		8 690	5.1	46	0.63	1.84	2.1	1.6	1.6				3300	5000																	
2.4	BN 100LB	2 2900	7.9	75	0.82	5.6	5.4	2.1	2.0	61	25	FD 15	26	550	700	65	31	FA 15	26	700	3500	65	32	BA 100	50	600	3100	72	36		
0.55		8 700	7.5	54	0.58	2.5	2.6	1.8	1.8				2000	3500																	
3	BN 112M	2 2900	9.9	76	0.87	6.5	6.3	2.1	1.9	98	30	FD 06S	40	—	900	107	40	FA 06S	40	900	2900	107	42	BA 110	75	800	2700	114	43		
0.75		8 690	10.4	60	0.65	2.8	2.5	1.6	1.6				—	—	—	—	—	—	—	—	—	—	—	—	—	—	—	—	—	—	—
4	BN 132S	2 2870	13.3	73	0.84	9.4	5.6	2.3	2.4	213	44	FD 56	37	—	500	223	57	FA 06	37	500	3500	223	58	BA 140	150	400	3000	263	76		
1		8 690	13.8	66	0.62	3.5	2.9	1.9	1.8				—	—	—	—	—	—	—	—	—	—	—	—	—	—	—	—	—	—	—
5.5	BN 132M	2 2870	18.3	75	0.84	12.6	6.1	2.4	2.5	270	53	FD 06	50	—	400	280	66	FA 06	50	400	2400	280	67	BA 140	150	350	2100	320	85		
1.5		8 690	21	68	0.63	5.1	2.9	1.9	1.9				—	—	—	—	—	—	—	—	—	—	—	—	—	—	—	—	—	—	—

2/12 P**3000/500 МИН⁻¹ - S3 60/40%****50 Hz**

Pn kW		n МИН ⁻¹	Mn Нм	η %	cos φ	In [400В] А	Is In	Ms Mn	Ma Mn	Jm x10 ⁻⁴ Кгм ²	IM B5 	Тормоз пост/ток						Тормоз пер/ток									
												FD			FA			BA									
		Мод.	Mb Нм	Z ₀ 1/h	NB	SB	IM B5 	Мод.	Mb Нм	Z ₀ 1/h	IM B5 	Мод.	Mb max Нм	Z ₀ 1/h	IM B5 												
0.55	BN 80B	2	1.86	64	0.89	1.39	4.2	1.6	1.7	25	11.3	FD 04	5	1000	1300	15.2	FA 04	5	1300	12000	15.1	BA 80	18	1200	28	16.6	
0.09		12	2.0	30	0.63	0.69	1.8	1.9	1.8				8000	12000										11000			
0.75	BN 90L	2	2.6	56	0.89	2.17	4.2	1.8	1.7	26	12.6	FD 05	13	1000	1150	18.6	FA 05	13	1150	6300	19.3	BA 90	35	1050	33	19.9	
0.12		12	2.7	26	0.63	1.06	1.7	1.4	1.6				4600	6300									5700				
1.1	BN 100LA	2	3.7	65	0.85	2.87	4.5	1.6	1.8	40	18.3	FD 15	13	700	900	25	FA 15	13	900	6000	25	BA 100	50	750	52	29	
0.18		12	4.0	26	0.54	1.85	1.5	1.3	1.5				4000	6000									5000				
1.5	BN 100LB	2	4.9	67	0.86	3.76	5.6	1.9	1.9	54	22	FD 15	13	700	900	28	FA 15	13	900	5000	29	BA 100	50	800	66	32	
0.25		12	5.4	36	0.46	2.18	1.8	1.7	1.8				3800	5000									4300				
2	BN 112M	2	6.6	74	0.88	4.43	6.5	2.1	2	98	30	FD 06S	20	—	800	107	40	FA 06S	20	800	3400	42	BA 110	75	750	114	43
0.3		12	6.2	46	0.43	2.19	2	2.1	2				—	3400									3200				
3	BN 132S	2	9.8	74	0.87	6.7	6.8	2.3	1.9	213	44	FD 56	37	—	450	223	57	FA 06	37	450	3000	58	BA 140	150	380	263	76
0.5		12	10.2	51	0.43	3.3	2	1.7	1.6				—	3000									2500				
4	BN 132M	2	13.1	75	0.89	8.6	5.9	2.4	2.3	270	53	FD 56	37	—	400	280	66	FA 06	37	400	2800	67	BA 140	150	350	320	85
0.7		12	14.5	53	0.44	4.3	1.9	1.7	1.6				—	2800									2500				

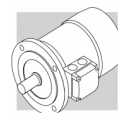

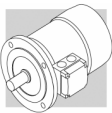





50 Hz

1500/1000 МИН⁻¹ - S1

4/6 P

Pn kW	Image	n МИН ⁻¹	Mn Нм	η %	cos φ	In [400В] А	Is In	M _s Mn	M _a Mn	Jm x10 ⁻⁴ Кгм ²	IM B5 Kg	Тормоз пост/ток				Тормоз пер/ток								
												Мод.	Mb Нм	Z ₀ 1/с	SB	Мод.	Mb Нм	Z ₀ 1/с	IM B5 Kg	Мод.	Mb Нм	Z ₀ 1/с	IM B5 Kg	
0.22	BN 71B	4	1.5	64	0.74	0.67	3.9	1.8	1.9	9.1	7.3	10	FD 03	3.5	2500	3500	FA 03	3.5	3500	BA 70	8	3200	11.2	11.2
0.13		6	1.4	43	0.67	0.65	2.3	1.6	1.7	9.1	7.3		5000	9000	9000	9000	9000	9000	8200	8200	11.1	11.1		
0.30	BN 80A	4	2.0	61	0.82	0.87	3.5	1.3	1.5	15	8.2	12.1	FD 04	5	2500	3100	FA 04	5	3100	BA 80	18	2800	13.5	13.5
0.20		6	1.9	54	0.66	0.81	3.2	1.9	2.0	15	8.2		4000	6000	6000	6000	6000	6000	5500	5500	18	18	18	18
0.40	BN 80B	4	2.7	63	0.75	1.22	3.9	1.8	1.8	20	9.9	13.8	FD 04	10	1800	2300	FA 04	10	2300	BA 80	18	2200	15.2	15.2
0.26		6	2.7	55	0.70	0.97	2.7	1.5	1.6	20	9.9		3600	5500	5500	5500	5500	5500	5200	5200	23	23	23	23
0.55	BN 90S	4	3.7	70	0.78	1.45	4.5	2.0	1.9	21	12.2	16.1	FD 14	10	1500	2100	FA 14	10	2100	BA 90	35	1700	19.5	19.5
0.33		6	3.4	62	0.70	1.10	3.7	2.3	2.0	21	12.2		2500	4100	4100	4100	4100	4100	3300	3300	28	28	28	28
0.75	BN 90L	4	5.0	74	0.78	1.88	4.3	1.9	1.8	28	14	20	FD 05	13	1400	2000	FA 05	13	2000	BA 90	35	1800	21	21
0.45		6	4.7	66	0.71	1.39	3.3	2.0	1.9	28	14		2300	3600	3600	3600	3600	3600	3300	3300	35	35	35	35
1.1	BN 100LA	4	7.2	74	0.79	2.72	5.0	1.7	1.9	82	22	28	FD 15	26	1400	2000	FA 15	26	2000	BA 100	50	1800	32	32
0.8		6	8.0	65	0.69	2.57	4.1	1.9	2.1	82	22		2100	3300	3300	3300	3300	3300	3000	3000	94	94	94	94
1.5	BN 100LB	4	9.9	75	0.79	3.65	5.1	1.7	1.9	95	25	31	FD 15	26	1300	1800	FA 15	26	1800	BA 100	50	1600	34	34
1.1		6	11.1	72	0.68	3.24	4.3	2.0	2.1	95	25		2000	3000	3000	3000	3000	3000	2800	2800	107	107	107	107
2.3	BN 112M	4	15.2	75	0.78	5.7	5.2	1.8	1.9	168	32	42	FD 06S	40	—	1600	FA 06S	40	1600	BA 110	75	1500	45	45
1.5		6	14.9	73	0.72	4.1	4.9	2.0	2.0	168	32		—	2400	2400	2400	2400	2400	2300	2300	184	184	184	184
3.1	BN 132S	4	20	83	0.83	6.5	5.9	2.1	2.0	213	44	57	FD 56	37	—	1200	FA 06	37	1200	BA 140	150	1000	76	76
2		6	20	77	0.75	4.9	4.5	2.1	2.1	213	44		—	1900	1900	1900	1900	1900	1600	1600	263	263	263	263
4.2	BN 132MA	4	27	84	0.82	8.8	5.9	2.1	2.2	270	53	66	FD 06	50	—	900	FA 06	50	900	BA 140	150	800	85	85
2.6		6	26	79	0.72	6.6	4.3	2.0	2.0	270	53		—	1500	1500	1500	1500	1500	1300	1300	320	320	320	320

4/8 P**1500/750 МИН⁻¹ - S1****50 Hz**

Pn kW		n МИН ⁻¹	Min Нм	η %	cos φ	In [400В] А	Is In	Ms Mn	Ma Mn	Jm x10 ⁻⁴ Кгм ²	IM B5 	Тормоз пост/ток						Тормоз пер/ток										
												FD			FA			BA										
		Mod.	Mb Нм	Z ₀ 1/h	NB	SB					Mod.	Mb Нм	Z ₀ 1/h	Jm x10 ⁻⁴ Кгм ²	IM B5 	Mod.	Mb Нм	Z ₀ 1/h	Jm x10 ⁻⁴ Кгм ²	IM B5 								
0.37	BN 80A	4	2.5	63	0.82	1.03	3.3	1.4	1.4	15	8.2	FD 04	10	2300	3500	16.6	12.1	FA 04	10	3500	7000	16.6	12.0	BA 80	18	3200	18	13.5
0.18		8	2.5	44	0.60	0.98	2.2	1.5	1.6				4500	7000											6500			
0.55	BN 80B	4	3.8	65	0.86	1.42	3.8	1.7	1.6	20	9.9	FD 04	10	2200	2900	22	13.8	FA 04	10	2900	6500	22	13.7	BA 80	18	2500	23	15.2
0.30		8	4.3	49	0.65	1.36	2.3	1.7	1.8				4200	6500											5600			
0.65	BN 90S	4	4.5	73	0.85	1.51	4.0	1.9	1.9	28	13.6	FD 14	15	2300	2800	30	17.8	FA 14	15	2800	6000	30	17.7	BA 90	35	2400	35	21
0.35		8	4.8	49	0.57	1.81	2.5	2.1	2.2				3500	6000											5100			
0.9	BN 90L	4	6.3	73	0.87	2.05	3.8	1.8	1.8	30	15.1	FD 05	26	1700	2100	34	21	FA 05	26	2100	4200	34	22	BA 90	35	1900	37	22
0.5		8	7.1	57	0.62	2.04	2.4	2.1	2				2500	4200											3800			
1.3	BN 100LA	4	8.7	72	0.83	3.14	4.3	1.7	1.8	82	22	FD 15	40	1300	1700	86	28	FA 15	40	1700	3400	86	29	BA 100	50	1500	94	32
0.7		8	9.6	58	0.64	2.72	2.8	1.8	1.8				2000	3400											3100			
1.8	BN 100LB	4	12.1	69	0.87	4.3	4.2	1.6	1.7	95	25	FD 15	40	1200	1700	99	31	FA 15	40	1700	2600	99	32	BA 100	50	1500	107	34
0.9		8	12.3	62	0.63	3.3	3.2	1.7	1.8				1600	2600											2400			
2.2	BN 112M	4	14.6	77	0.85	4.9	5.3	1.8	1.8	168	32	FD 06S	60	—	1200	177	42	FA 06S	60	1200	2000	177	43	BA 110	75	1100	184	45
1.2		8	16.1	70	0.63	3.9	3.3	1.9	1.8				—	2000											1900			
3.6	BN 132S	4	24	80	0.82	7.9	6.5	2.1	1.9	295	45	FD 56	75	—	1000	305	58	FA 06	75	1000	1400	305	59	BA 140	150	900	345	77
1.8		8	24	72	0.55	6.6	4.6	1.9	2				—	1400											1200			
4.6	BN 132M	4	30	81	0.83	9.9	6.5	2.2	1.9	383	56	FD 06	100	—	1000	393	69	FA 07	100	1000	1300	406	74	BA 140	150	900	433	88
2.3		8	31	73	0.54	8.4	4.4	2.3	2				—	1300											1200			

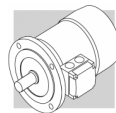

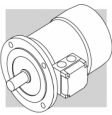





50 Hz

3000 МИН⁻¹ - S1

2 P

Pn kW	Pn kW	n МИН ⁻¹	Mn НМ	EFF2	η (100%) %	η (75%) %	cos φ	In [400V] A	Is In	Ms Mn	Ma Mn	Jm x10 ⁻⁴ Кгм ²	IM B9 Kg	Тормоз пост/ток				Тормоз пер/ток						
														Мод.	НМ	SB	Zo 1/h	Мод.	НМ	Zo 1/h	IM B9 Kg			
0.18	M 05A	2	0.63		59.9	56.9	0.77	0.56	3.0	2.1	2.0	2.0	3.2	FD 02	1.75	3900	4800	4800	FA 02	1.75	4800	4800	4.7	
0.25	M 05B	2	0.87		66.0	64.8	0.76	0.72	3.3	2.3	2.3	2.3	3.6	FD 02	1.75	3900	4800	4800	FA 02	1.75	4800	4800	5.1	
0.37	M 05C	2	1.26		69.1	66.8	0.78	0.99	3.9	2.6	2.6	3.3	4.8	FD 02	3.5	3600	4500	4500	FA 02	3.5	4500	4500	6.3	
0.55	M 1SD	2	1.86		76.0	75.8	0.76	1.37	5	2.9	2.8	4.1	5.8	FD 03	5	2900	4200	4200	FA 03	5	4200	4200	8.2	
0.75	M 1LA	2	2.6		76.6	76.2	0.76	1.86	5.1	3.1	2.8	5.0	6.9	FD 03	5	1900	3300	3300	FA 03	5	3300	3300	9.3	
1.1	M 2SA	2	3.8	EFF2	76.4	76.2	0.81	2.57	4.8	2.8	2.4	9.0	8.8	FD 04	10	1500	3000	3000	FA 04	10	3000	3000	12.6	
1.5	M 2SB	2	5.1	EFF2	79.1	79.5	0.81	3.4	4.9	2.7	2.4	11.4	10.6	FD 04	15	1300	2600	2600	FA 04	15	2600	2600	14.4	
2.2	M 3SA	2	7.4		80.2	80.9	0.78	5.1	5.2	2.1	1.8	24	15.5	FD 15	26	1100	2400	2400	FA 15	26	2400	2400	23	
3	M 3LA	2	10.0	EFF2	82.8	82.6	0.79	6.6	5.7	2.6	2.2	31	18.7	FD 15	26	700	1600	1600	FA 15	26	1600	1600	26	
4	M 3LB	2	13.3	EFF2	84.3	84.4	0.80	8.6	5.9	2.7	2.5	39	22	FD 15	40	450	900	900	FA 15	40	900	900	29	
5.5	M 4SA	2	18.2	EFF2	86.1	85.7	0.84	11.0	6	2.6	2.2	101	33	FD 06	50	—	600	600	FA 06	50	600	600	47	
7.5	M 4SB	2	25	EFF2	87.2	87.1	0.85	14.6	6.4	2.6	2.2	145	40	FD 06	50	—	550	550	FA 06	50	550	550	54	
9.2	M 4LA	2	30	EFF2	89.0	88.5	0.86	17.3	6.9	2.8	2.3	178	51	FD 56	75	—	430	430	FA 06	75	430	430	65	
11	M 4LC	2	36	EFF2	89.1	88.9	0.88	20.2	7	2.9	2.5	210	60											
15	M 5SB	2	49	EFF2	89.6	89.4	0.86	28.1	7.1	2.6	2.3	340	70											
18.5	M 5SC	2	60	EFF2	90.4	90.1	0.86	34	7.6	2.7	2.3	420	83											
22	M 5LA	2	72	EFF2	91.3	91.3	0.88	40	7.8	2.6	2.4	490	95											

Pn kW		n МИН ⁻¹	Mn Нм		η (100%) %	η (75%) %	cos φ	In [400В] А	Is In	Ms Mn	Ma Mn	Jm x10 ⁻⁴ Кгм ²	IM B9 	Тормоз пост/ток					Тормоз пер/ток							
														Мод.	Мб Нм	Zo 1/н	SB	Jm x10 ⁻⁴ Кгм ²	IM B9 	Мод.	Мб Нм	Zo 1/н	Jm x10 ⁻⁴ Кгм ²	IM B9 		
0.09	M 0B	4	1350	0.64	51.7	47.6	0.60	0.42	2.6	2.5	2.4	1.5	2.9	FD 02	1.75	10000	13000	—	2.6	4.9	FA 02	1.75	13000	—	2.6	4.7
0.12	M 05A	4	1350	0.85	59.8	56.2	0.62	0.47	2.6	1.9	1.8	2.0	3.2	FD 02	3.5	10000	13000	—	3.0	5.3	FA 02	3.5	13000	—	3.0	5.1
0.18	M 05B	4	1320	1.30	54.8	52.9	0.67	0.71	2.6	2.2	2.0	2.3	3.6	FD 02	3.5	7800	10000	—	3.9	6.5	FA 02	3.5	10000	—	3.9	6.3
0.25	M 05C	4	1340	1.78	65.3	65.0	0.69	0.80	2.7	2.1	1.9	3.3	4.8	FD 03	5	6000	9400	—	8.0	8.2	FA 03	5	9400	—	8.0	7.9
0.37	M 1SD	4	1370	2.6	66.8	66.7	0.76	1.05	3.7	2	1.9	6.9	5.5	FD 53	7.5	4300	8700	—	10.2	9.6	FA 03	7.5	8700	—	10.2	9.3
0.55	M 1LA	4	1380	3.8	69.0	68.9	0.74	1.55	4.1	2.3	2.3	9.1	6.9	FD 04	15	4100	7800	—	22	13.1	FA 04	15	7800	—	22	13
0.75	M 2SA	4	1400	5.1	75.0	74.5	0.78	1.85	4.9	2.7	2.5	20	9.2	FD 04	15	2600	5300	—	27	14.5	FA 04	15	5300	—	27	14.4
1.1	M 2SB	4	1400	7.5	76.4	76.2	0.78	2.66	5.1	2.8	2.5	25	10.6	FD 15	26	2800	4900	—	38	22	FA 15	26	4900	—	38	23
1.5	M 3SA	4	1410	10.2	79.6	80.5	0.77	3.5	4.6	2.1	2.1	34	15.5	FD 15	40	2600	4700	—	44	24	FA 15	40	4700	—	44	24
2.2	M 3LA	4	1410	14.9	81.1	81.4	0.75	5.2	4.5	2.2	2	40	17	FD 15	40	2400	4400	—	58	27	FA 15	40	4400	—	58	28
3	M 3LB	4	1410	20	82.6	83.8	0.77	6.8	5	2.3	2.2	54	21	FD 55	55	—	1300	—	65	29	FA 15	40	1300	—	65	30
4	M 3LC	4	1400	27	82.7	83.1	0.78	9.0	4.7	2.3	2.2	61	23	FD 56	75	—	1050	—	223	55	FA 06	75	1050	—	223	56
5.5	M 4SA	4	1440	36	86.3	86.4	0.80	11.5	5.5	2.3	2.2	213	42	FD 06	100	—	950	—	280	64	FA 07	100	950	—	280	65
7.5	M 4LA	4	1440	50	87	87.1	0.80	15.6	5.7	2.5	2.4	270	51	FD 07	150	—	900	—	342	73	FA 07	150	900	—	342	75
9.2	M 4LB	4	1440	61	88.4	88.6	0.80	18.8	5.9	2.7	2.5	319	57	FD 07	150	—	850	—	382	81	FA 07	150	850	—	382	83
11	M 4LC	4	1440	73	88.4	88.8	0.81	22.2	5.9	2.7	2.5	360	65	FD 08	200	—	750	—	865	115	FA 08	200	750	—	865	114
15	M 5SB	4	1460	98	89.9	89.4	0.81	29.7	5.9	2.3	2.1	650	85	FD 08	250	—	700	—	850	131	FA 08	250	700	—	850	130
18.5	M 5LA	4	1460	121	90.0	90.1	0.81	37	6.2	2.6	2.5	790	101	FD 08	250	—	700	—	865	131	FA 08	250	700	—	865	130

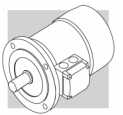

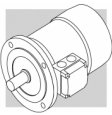







6 P

1000 МИН⁻¹ - S1

50 Hz

Pn kW		n МИН ⁻¹	Mn Нм	η %	cos φ	In [400В] А	Is In	Ms Mn	Ma Mn	Jm x10 ⁻⁴ Кгм ²	IM B9  Kg	Тормоз пост/ток						Тормоз пер/ток						
												FD			FA									
												Мод.	Мб	Z _c 1/н	SB	IM B9  Kg	Мод.	Мб	Z _c 1/н	Jm x10 ⁻⁴ Кгм ²	IM B9  Kg			
0.09	M 05A	6	0.98	41	0.53	0.60	2.1	2.1	1.8	3.4	4.3	FD 02	3.5	9000	14000	9000	14000	4.0	6.0	FA 02	3.5	14000	4.0	5.8
0.12	M 05B	6	1.32	45	0.60	0.64	2.1	1.9	1.7	3.7	4.6	FD 02	3.5	9000	14000	9000	14000	4.3	6.3	FA 02	3.5	14000	4.3	6.1
0.18	M 15C	6	1.91	56	0.69	0.67	2.6	1.9	1.7	8.4	5.1	FD 03	5	8100	13500	8100	13500	9.5	7.8	FA 03	5	13500	9.5	7.5
0.25	M 15D	6	2.7	62	0.71	0.82	2.6	1.9	1.7	10.9	6.3	FD 03	5	7800	13000	7800	13000	12	9	FA 03	5	13000	12	8.7
0.37	M 15LA	6	3.9	66	0.69	1.17	3	2.4	2	12.9	7.3	FD 53	7.5	5100	9500	5100	9500	14	10	FA 03	7.5	9500	14	9.7
0.55	M 25A	6	5.7	70	0.69	1.64	3.9	2.6	2.2	25	10.6	FD 04	15	4800	7200	4800	7200	27	14.5	FA 04	15	7200	27	14.4
0.75	M 25B	6	7.8	70	0.65	2.38	3.8	2.5	2.2	28	11.5	FD 04	15	3400	6400	3400	6400	30	15.4	FA 04	15	6400	30	15.3
1.1	M 35A	6	11.4	72	0.69	3.2	3.9	2.3	2	33	17	FD 05	26	2700	5000	2700	5000	37	23	FA 15	26	5000	37	24
1.5	M 35LA	6	15.2	73	0.72	4.1	4	2.1	2	82	21	FD 15	40	1900	4100	1900	4100	86	27	FA 15	40	4100	86	28
1.85	M 35LB	6	19.0	75	0.73	4.9	4.5	2.1	2	95	23	FD 15	40	1700	3600	1700	3600	99	29	FA 15	40	3600	99	30
2.2	M 35LC	6	23	75	0.71	6.0	4.6	2	1.9	95	23	FD 55	55	—	1900	—	1900	99	29	FA 15	55	1900	99	30
3	M 45A	6	30	76	0.76	7.5	4.8	1.9	1.8	216	34	FD 56	75	—	1400	—	1400	226	47	FA 06	75	1400	226	48
4	M 45LA	6	40	78	0.77	9.6	5.5	2	1.8	295	43	FD 06	100	—	1200	—	1200	305	56	FA 07	100	1200	305	57
5.5	M 45LB	6	56	80	0.78	12.7	5.9	2.1	1.9	383	54	FD 07	150	—	1050	—	1050	406	70	FA 07	150	1050	406	72
7.5	M 55A	6	75	84	0.81	15.9	5.9	2.2	2	740	69	FD 08	170	—	900	—	900	815	98	FA 08	170	900	800	98
11	M 55B	6	109	87	0.81	22.5	6.5	2.5	2.3	970	89	FD 08	200	—	800	—	800	1045	119	FA 08	200	800	1030	118

Pn kW		n МИН ⁻¹	Mn Нм	η %	cos φ	In [400В] А	Is In	Is Mn	Ms Mn	Ma Mn	Jm x10 ⁻⁴ Кгм ²	IM B9 	Тормоз пост/ток				Тормоз пер/ток										
													Мод.	Mb Нм	Zo 1/h	SB	Jm x10 ⁻⁴ Кгм ²	IM B9 	Мод.	Mb Нм	Zo 1/h	Jm x10 ⁻⁴ Кгм ²					
0.20	M 05A	2	2700	55	0.82	0.64	3.5	2.1	1.9	1.9	2.9	4.1	FD 02	3.5	2200	2600	2600	3.5	2600	3.5	5.8	FA 02	3.5	2600	2600	3.5	5.6
0.15		4	1350	49	0.67	0.66	2.6	1.8	1.7	1.7	4.7	4	FD 03	3.5	4000	5100	5100	5.8	5100	5.8	6.7	FA 03	3.5	2400	2400	5.8	6.4
0.28	M 15B	2	2700	56	0.82	0.88	2.9	1.9	1.7	1.7	5.8	4.7	FD 03	5	2100	2400	2400	6.9	2400	6.9	7.4	FA 03	5	2100	2100	6.9	7.1
0.20		4	1370	59	0.68	1.02	3.1	1.8	1.7	1.7	5.8	4.7	FD 03	5	3800	4800	4800	6.9	4800	6.9	7.4	FA 03	5	2100	2100	6.9	7.1
0.37	M 15C	2	2740	56	0.82	1.16	3.5	1.8	1.8	1.8	5.8	4.7	FD 03	5	1400	2100	2100	8	2100	8	8.2	FA 03	5	2100	2100	8	7.9
0.25		4	1390	60	0.73	0.82	3.3	2	1.9	1.9	6.9	5.5	FD 03	5	2900	4200	4200	10.2	4200	10.2	9.6	FA 03	5	2200	2200	10.2	9.3
0.45	M 15D	2	2780	63	0.85	1.21	3.8	1.8	1.8	1.8	9.1	6.9	FD 03	5	1400	2100	2100	22	2100	22	13.1	FA 04	10	1600	1600	22	13
0.30		4	1400	63	0.74	0.93	3.8	2.1	1.9	1.9	20	9.2	FD 04	10	2900	4200	4200	27	4200	27	14.5	FA 04	10	1500	1500	27	14.5
0.55	M 1LA	2	2800	73	0.79	1.38	4.2	2	1.8	1.8	25	10.7	FD 04	10	1600	2200	2200	38	2200	38	22	FA 15	26	1000	1000	38	23
0.37		4	1400	68	0.72	1.09	3.9	2.2	2	2	34	15.5	FD 15	26	3300	4600	4600	44	4600	44	24	FA 15	26	2600	2600	44	24
0.75	M 2SA	2	2780	65	0.85	1.96	3.8	1.9	1.8	1.8	40	17	FD 15	26	1400	1600	1600	65	1600	65	29	FA 15	40	900	900	65	30
0.55		4	1400	68	0.81	1.44	3.9	1.7	1.7	1.7	213	42	FD 06	50	2700	3600	3600	233	3600	233	55	FA 06	50	400	400	233	56
1.1	M 2SB	2	2730	65	0.86	2.84	3.9	2	1.9	1.9	25	10.7	FD 04	10	1200	1500	1500	44	1500	44	24	FA 15	26	900	900	44	24
0.75		4	1410	75	0.81	1.78	4.5	2.1	2	2	34	15.5	FD 15	26	2300	3100	3100	65	3100	65	22	FA 15	26	2300	2300	65	23
1.5	M 3SA	2	2830	74	0.83	3.5	4.7	2.1	2	2	40	17	FD 15	26	700	1000	1000	65	1000	65	29	FA 15	40	900	900	65	30
1.1		4	1420	77	0.78	2.6	4.3	2.1	2	2	40	17	FD 15	26	1600	2600	2600	65	2600	65	29	FA 15	40	2100	2100	65	30
2.2	M 3LA	2	2800	72	0.85	5.2	4.5	2	1.9	1.9	40	17	FD 15	26	600	900	900	233	900	233	55	FA 06	50	400	400	233	56
1.5		4	1410	73	0.79	3.8	4.7	2	2	2	213	42	FD 06	50	1300	2300	2300	223	2300	223	55	FA 06	75	350	350	223	56
3.5	M 3LB	2	2850	80	0.84	7.5	5.4	2.2	2.1	2.1	61	23	FD 15	40	500	900	900	280	900	280	64	FA 07	100	350	350	280	65
2.5		4	1420	82	0.80	5.5	5.2	2.2	2.2	2.2	270	51	FD 06	100	1000	2100	2100	342	2100	342	73	FA 07	150	300	300	342	75
4.8	M 4 SA	2	2900	81	0.88	9.7	6	2	1.9	1.9	213	42	FD 06	50	—	400	400	233	400	233	55	FA 06	50	400	400	233	56
3.8		4	1430	81	0.84	8.1	5.2	2.1	2.1	2.1	213	42	FD 06	75	—	950	950	223	950	223	55	FA 06	75	350	350	223	56
5.5	M 4SB	2	2890	80	0.87	11.4	5.9	2.4	2	2	270	51	FD 06	100	—	350	350	280	350	280	64	FA 07	100	350	350	280	65
4.4		4	1440	82	0.84	9.2	5.3	2.2	2	2	319	57	FD 06	150	—	900	900	342	900	342	73	FA 07	150	300	300	342	75
7.5	M 4LA	2	2900	82	0.87	15.2	6.5	2.4	2	2.1	319	57	FD 07	150	—	350	350	342	350	342	73	FA 07	150	300	300	342	75
6		4	1430	84	0.85	12.1	5.8	2.3	2.1	2.1	319	57	FD 07	150	—	950	950	342	950	342	73	FA 07	150	300	300	342	75
9.2	M 4LB	2	2920	83	0.86	18.6	6	2.6	2.2	2.1	319	57	FD 07	150	—	800	800	342	800	342	73	FA 07	150	300	300	342	75
7.3		4	1440	85	0.85	14.6	5.5	2.3	2.1	2.1	319	57	FD 07	150	—	800	800	342	800	342	73	FA 07	150	300	300	342	75

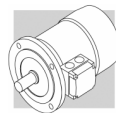

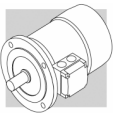







50 Hz

3000/1000 МИН⁻¹ - S3 60/40%

2/6 P

Pn kW		n МИН ⁻¹	Mn Нм	η %	cos φ	In [400В] А	Is In	Ms Mn	Ma Mn	Jm x10 ⁻⁴ Кгм ²	IM B9  Kg	Тормоз пост/ток						Тормоз пер/ток							
												FD			FA										
		Mod.		Mb Нм	Z ₀ 1/h	NB	SB	Jm x10 ⁻⁴ Кгм ²		Z ₀ 1/h	Mb Нм	Mod.	Mb Нм	Z ₀ 1/h	Jm x10 ⁻⁴ Кгм ²	IM B9  Kg									
0.25	M 1SA	2	2850	0.84	0.82	0.73	4.3	1.9	1.8	6.9	5.5	FD 03	1.75	1500	1700	10000	13000	8	8.2	FA 03	1.75	1700	13000	8	7.9
0.08		6	910	0.84	0.70	0.38	2.1	1.4	1.5																
0.37	M 1LA	2	2880	1.23	0.80	1.08	4.4	1.9	1.8	9.1	6.9	FD 03	3.5	1000	1300	9000	11000	10.2	9.6	FA 03	3.5	1300	11000	10.2	9.3
0.12		6	900	1.27	0.73	0.54	2.4	1.4	1.5																
0.55	M 2SA	2	2800	1.88	0.86	1.47	4.5	1.9	1.7	20	9.2	FD 04	5	1500	1800	4100	6300	22	13.1	FA 04	5	1800	6300	22	13
0.18		6	930	1.85	0.65	0.77	3.3	2.0	1.9																
0.75	M 2SB	2	2800	2.6	0.87	1.89	4.3	1.8	1.6	25	10.6	FD 04	5	1700	1900	3800	6000	27	14.5	FA 04	5	1900	6000	27	14.4
0.25		6	930	2.6	0.67	1.00	3.2	1.7	1.8																
1.1	M 3SA	2	2870	3.7	0.82	2.73	4.9	1.8	1.9	34	15.5	FD 15	13	1000	1300	3500	5000	38	22	FA 15	13	1300	5000	38	23
0.37		6	930	3.8	0.70	1.21	3.1	1.5	1.8																
1.5	M 3LA	2	2880	5.0	0.84	3.53	5.1	1.9	2.0	40	17	FD 15	13	1000	1200	2900	4000	44	24	FA 15	13	1200	4000	44	24
0.55		6	940	5.6	0.67	1.85	3.5	1.7	1.8																
2.2	M 3LB	2	2900	7.2	0.85	4.9	5.9	2.0	2.0	61	23	FD 15	26	700	900	2100	3000	65	29	FA 15	26	900	3000	65	30
0.75		6	950	7.5	0.64	2.5	3.3	1.9	1.8																
3	M 4SA	2	2910	9.9	0.88	6.6	5.6	2.0	2.1	170	36	FD 56	37	—	600	—	182	182	48	FA 06	37	600	182	182	50
1.1		6	960	10.9	0.68	3.2	4.5	2.2	2																
4.5	M 4SB	2	2910	14.8	0.84	9.9	5.8	1.9	1.8	213	42	FD 56	37	—	500	—	223	223	55	FA 06	37	500	223	223	56
1.5		6	960	14.9	0.67	4.4	4.2	1.9	2.0																
5.5	M 4LA	2	2920	18.0	0.87	11.7	6.2	2.1	1.9	270	51	FD 06	50	—	400	—	280	280	64	FA 06	50	400	280	280	65
2.2		6	960	22	0.71	5.8	4.3	2.1	2.0																

Pn kW		n МИН ⁻¹	Mn Нм	η %	cos φ	In [400В] А	Is In	Is In	Ms Mn	Ma Mn	Jm x10 ⁻⁴ Кгм ²	IM B9 	Тормоз пост/ток						Тормоз пер/ток				
													Мод.	Mb Нм	Zo 1/h	NB	SB	Jm x10 ⁻⁴ Кгм ²	IM B9 	Мод.	Mb Нм	Zo 1/h	Jm x10 ⁻⁴ Кгм ²
0.37	M 1LA	2	1.26	63	0.86	0.99	3.9	4.4	1.8	1.9	12.9	7.3	FD 03	3.5	1200	1300	14	10	FA 03	3.5	1300	14	9.7
		8	1.28	34	0.75	0.51	1.8	2.3	1.4	1.5	9500	9500	FD 04	5	5600	8000	22	13.1	FA 04	5	8000	22	13
0.55	M 2SA	2	1.86	66	0.86	1.40	4.4	4.4	2.1	2	20	9.2	FD 04	5	1500	1800	22	13.1	FA 04	5	1800	22	13
		8	1.80	41	0.64	0.72	2.3	2.3	1.6	1.7	5600	5600	FD 04	10	4800	7300	27	14.5	FA 04	10	7300	27	14.4
0.75	M 2SB	2	2.6	68	0.88	1.81	4.6	4.6	2.1	2	25	10.6	FD 04	10	1700	1900	27	14.5	FA 04	10	1900	27	14.4
0.18		8	2.5	43	0.66	0.92	2.3	2.3	1.6	1.7			FD 15	13	1000	1300	38	22	FA 15	13	1300	38	23
1.1	M 3SA	2	3.7	69	0.84	2.74	4.6	4.6	1.8	1.7	34	15.5	FD 15	13	3400	5000	38	22	FA 15	13	5000	38	23
0.28		8	3.9	44	0.56	1.64	2.3	2.3	1.4	1.7			FD 15	13	1000	1200	44	24	FA 15	13	1200	44	24
1.5	M 3LA	2	5.0	69	0.85	3.69	4.7	4.7	1.9	1.8	40	17	FD 15	13	3300	5000	44	24	FA 15	13	5000	44	24
0.37		8	5.1	46	0.63	1.84	2.1	2.1	1.6	1.6			FD 15	26	550	700	65	29	FA 15	26	700	65	30
2.4	M 3LB	2	7.9	75	0.82	5.6	5.4	5.4	2.1	2	61	23	FD 15	26	2000	3500	65	29	FA 15	26	3500	65	30
0.55		8	7.5	54	0.58	2.5	2.6	2.6	1.8	1.8			FD 15	37	—	—	182	48	FA 06	37	600	182	50
3	M 4SA	2	9.8	72	0.85	7.1	5.6	5.6	2	1.8	162	36	FD 56	37	—	—	182	48	FA 06	37	3400	182	50
0.75		8	10.1	61	0.64	2.8	3	3	1.7	1.8			FD 56	37	—	—	223	55	FA 06	37	500	223	56
4	M 4SB	2	13.3	73	0.84	9.4	5.6	5.6	2.3	2.4	213	42	FD 56	37	—	—	223	55	FA 06	37	3500	223	56
1		8	13.8	66	0.62	3.5	2.9	2.9	1.9	1.8			FD 06	50	—	—	280	64	FA 06	50	400	280	65
5.5	M 4LA	2	18.3	75	0.84	12.6	6.1	6.1	2.4	2.5	270	51	FD 06	50	—	—	280	64	FA 06	50	2400	280	65
1.5		8	21	68	0.63	5.1	2.9	2.9	1.9	1.9			FD 06	50	—	—	280	64	FA 06	50	2400	280	65

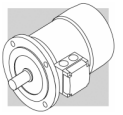

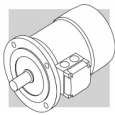



2/12 P

3000/500 МИН⁻¹ - S3 60/40%

50 Hz

Pn kW		n МИН ⁻¹	Mn Нм	η %	cos φ	In [400В] А	Is In	Ms Mn	Ma Mn	Jm x10 ⁻⁴ Кгм ²	IM B9 	Тормоз пост/ток FD					Тормоз пер/ток FA				
												Мод.	Mb Нм	Zo 1/h	NB	SB	Mb Нм	Zo 1/h	Mod.	Mb Нм	Zo 1/h
0.55	M 2SA	2820	1.86	64	0.89	1.39	4.2	1.6	1.7	25	10.6	FD 04	5	1000	1300	1300	5	1300	27	14.5	
0.09		430	2.0	30	0.63	0.69	1.8	1.9	1.8					8000	12000	12000		12000			
0.75	M 3SA	2900	2.5	65	0.81	2.06	5.2	1.9	2.1	34	15.5	FD 15	13	700	900	900	13	900	38	22	
0.12		460	2.5	33	0.43	1.22	1.9	1.3	1.6					5000	7000	7000		7000			
1.1	M 3LA	2850	3.7	65	0.85	2.87	4.5	1.6	1.8	40	17	FD 15	13	700	900	900	13	900	44	24	
0.18		430	4.0	26	0.54	1.85	1.5	1.3	1.5					4000	6000	6000		6000			
1.5	M 3LB	2900	4.9	67	0.86	3.76	5.6	1.9	1.9	54	21	FD 15	13	700	900	900	13	900	58	27	
0.25		440	5.4	36	0.46	2.18	1.8	1.7	1.8					3800	5000	5000		5000			
2	M 3LC	2850	6.7	70	0.84	4.9	4.9	1.8	1.7	61	23	FD 55	18	—	700	700	18	700	65	29	
0.3		450	6.4	38	0.47	2.4	1.7	1.6	1.7					—	3500	3500		3500			
3	M 4SA	2920	9.8	74	0.87	6.7	6.8	2.3	1.9	213	42	FD 56	37	—	450	450	37	450	223	55	
0.5		470	10.2	51	0.43	3.3	2	1.7	1.6					—	3000	3000		3000			
4	M 4LA	2920	13.1	75	0.89	8.6	5.9	2.4	2.3	270	51	FD 56	37	—	400	400	37	400	280	64	
0.7		460	14.5	53	0.44	4.3	1.9	1.7	1.6					—	2800	2800		2800			

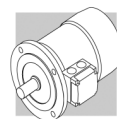

M12 - РАЗМЕРЫ ЭЛЕКТРОДВИГАТЕЛЕЙ

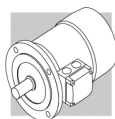

BN

IM B14

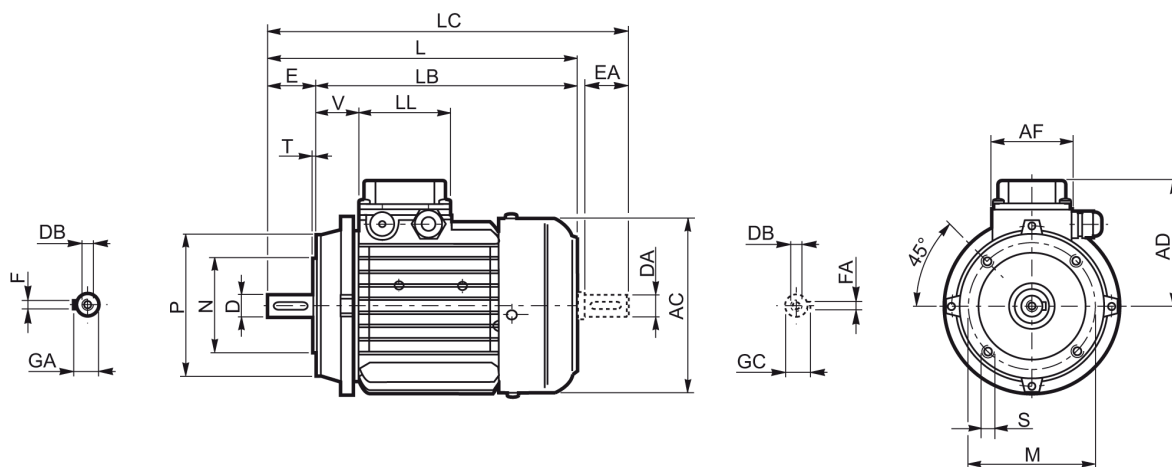

	Вал					Фланец					Мотор							
	D DA	E EA	DB	GA GC	F FA	M	N	P	S	T	AC	L	LB	LC	AD	AF	LL	V
BN 56	9	20	M3	10.2	3	65	50	80	M5	2.5	110	185	165	207	91	74	80	34
BN 63	11	23	M4	12.5	4	75	60	90			121	207	184	232				95
BN 71	14	30	M5	16	5	85	70	105	M6	3	138	249	219	281	108	98	98	37
BN 80	19	40	M6	21.5	6	100	80	120			156	274	234	315				119
BN 90	24	50	M8	27	8	115	95	140	M8	3.5	176	326	276	378	133	98	98	44
BN 100	28	60	M10	31		130	110	160			195	366	306	429				142
BN 112					219	385	325	448	157	52								
BN 132	38	80	M12	41	10	165	130	200	M10	4	258	493	413	576	193	118	118	58

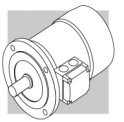

BN

IM B5

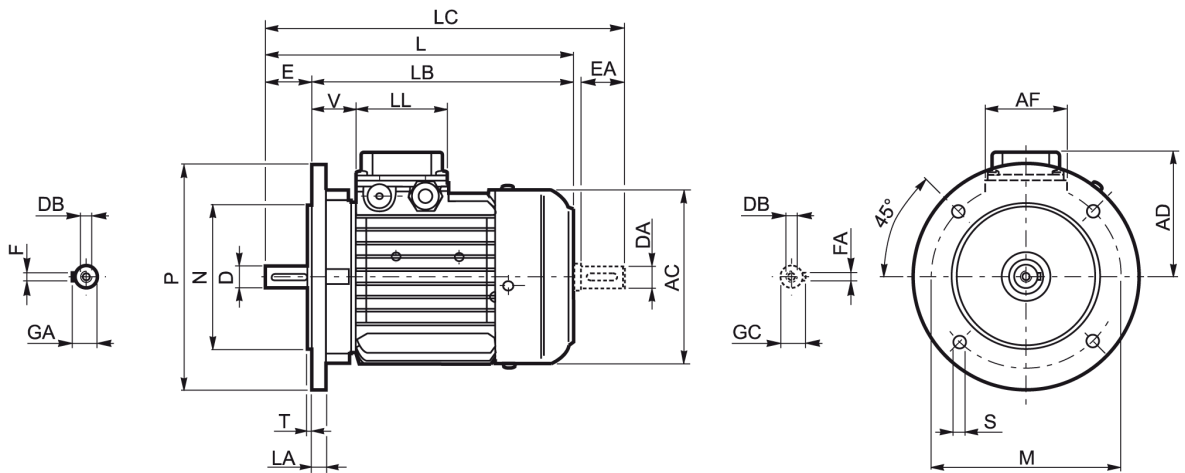

	Вал					Фланец						Мотор							
	D DA	E EA	DB	GA GC	F FA	M	N	P	S	T	LA	AC	L	LB	LC	AD	AF	LL	V
BN 56	9	20	M3	10.2	3	100	80	120	7	3	8	110	185	165	207	91	74	80	34
BN 63	11	23	M4	12.5	4	115	95	140	9.5		10	121	207	184	232	95			26
BN 71	14	30	M5	16	5	130	110	160			10	138	249	219	281	108			37
BN 80	19	40	M6	21.5	6	165	130	200	11.5	3.5	11.5	156	274	234	315	119	98	98	38
BN 90	24	50	M8	27	8						176	326	276	378	133	44			
BN 100	28	60	M10	31	8	215	180	250	14	4	14	195	367	307	429	142	98	98	50
BN 112		60									15	219	385	325	448	157			52
BN 132	38	80	M12	41	10	265	230	300	18.5	5	16	258	493	413	576	193	118	118	58
BN 160 MR											15	258	562	452	645				218
BN 160 M	42	110 80 (1)	M16 M12 (1)	45 41 (1)	12 10 (1)	300	250	350	18.5	5	15	310	596	486	680	245	187	187	51
BN 160 L	38 (1)																		
BN 180 M	48	110 110 (1)	M16 M16 (1)	51.5 41 (1)	14 10 (1)	350	300	400	18.5	5	15	310	640	530	724	261	187	187	52
BN 180 L	38 (1)																		
BN 180 L	42 (1)																		
BN 200 L	55		M20 M16 (1)	59 45 (1)	16 12 (1)	350	300	400	18.5	5	18	348	722	612	837	261			66

Примечание:

(1) – размер дан для заднего конца вала

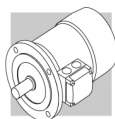

BN_FD

IM B14

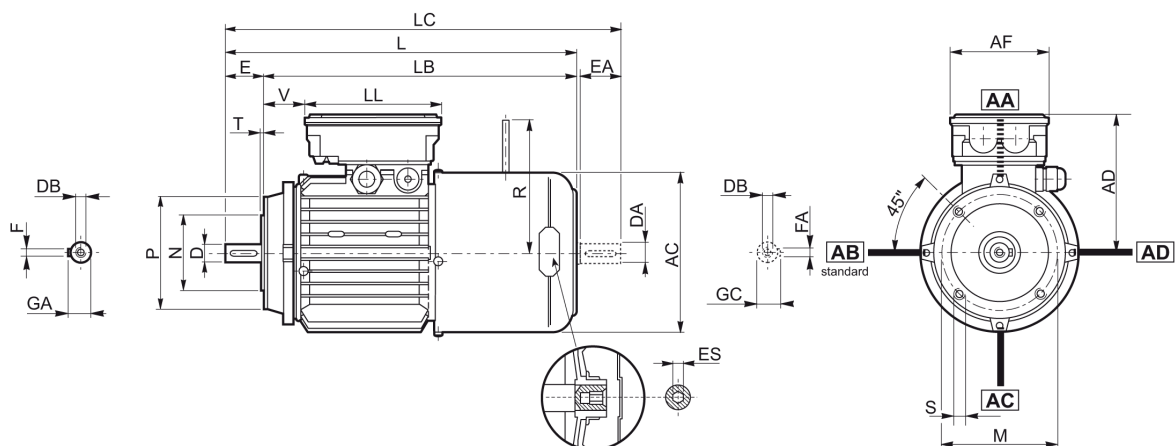

	Вал					Фланец					Мотор									
	D DA	E EA	DB	GA GC	F FA	M	N	P	S	T	AC	L	LB	LC	AD	AF	LL	V	R	ES
BN 63	11	23	M4	12.5	4	75	60	90	M5	2.5	121	272	249	297	119	98	133	14	96	5
BN 71	14	30	M5	16	5	85	70	105	M6		138	310	280	342	132			25	103	
BN 80	19	40	M6	21.5	6	100	80	120		M8	156	346	306	388	143			41	129	
BN 90 S	24	50	M8	27	8	115	95	140	M8		3	176	409	359	461	146	110	165	39	160
BN 90 L																				
BN 100	28	60	M10	31		130	110	160		3.5	195	458	398	521	155			62	199	
BN 112											219	484	424	547	170	73	199			
BN 132	38	80	M12	41	10	165	130	200	M10	4	258	603	523	686	210	140	188	122	204 (1)	

Примечание:

(1) – для тормоза FD 07 размер R=226

В электродвигателях исполнения PS шестигранник ES не предусмотрен

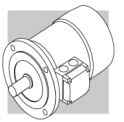

BN_FD

IM B5

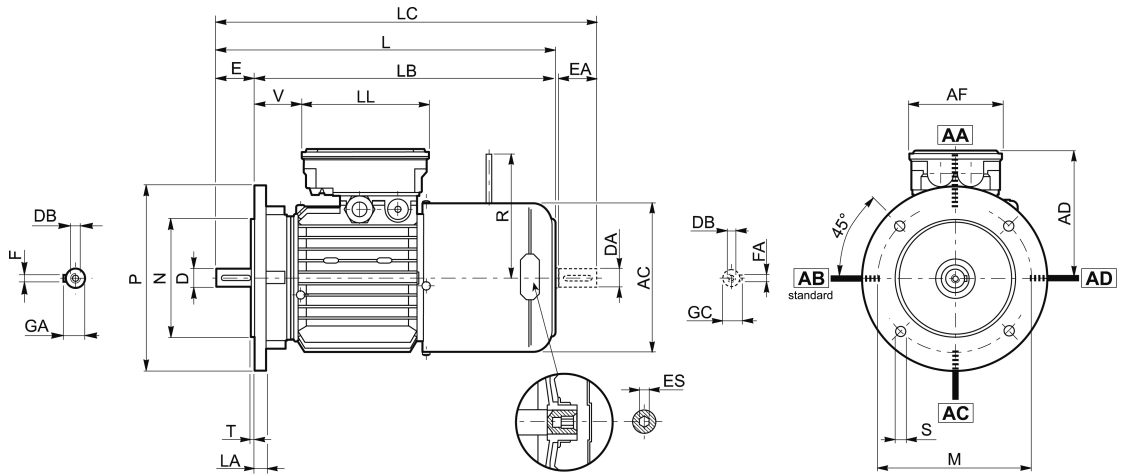

	Вал					Фланец						Мотор									
	D DA	E EA	DB	GA GC	F FA	M	N	P	S	T	LA	AC	L	LB	LC	AD	AF	LL	V	R	ES
BN 63	11	23	M4	12.5	4	115	95	140	9.5	3	10	121	272	249	297	119	98	133	14	96	5
BN 71	14	30	M5	16	5	130	110	160				138	310	280	342	132			25	103	
BN 80	19	40	M6	21.5	6	165	130	200				11.5	3.5	11.5	156	346			306	388	
BN 90 S	24	50	M8	27	8				176	409	359				461	146	39	160			
BN 90 L	28	60	M10	31	8	215	180	250	14	4	14	195	458	398	521	155	110	165	62	160	6
BN 100											15	219	484	424	547	170			73	199	
BN 112	38	80	M12	41	10	265	230	300	14	4	16	603	523	686	210	140	188	122	204 (2)	6	
BN 132											258	672	562	755	187	187	161	226			
BN 160 MR	42 38 (1)	110 80 (1)	M16 M12 (1)	45 41 (1)	12 10 (1)	300	250	350	18.5	5	15	310	736	626	820	245	187	187	51	266	—
BN 160 M												780	670	864	187	187					
BN 160 L	48 38 (1)	110	M16 M16 (1)	51.5 45 (1)	14 12 (1)	350	300	400	18	5	18	348	866	756	981	261	187	187	52	305	
BN 180 M												878	768	993	64						
-BN 180 L	55 42 (1)	110 (1)	M20 M16 (1)	59 45 (1)	16 12 (1)	350	300	400	18	5	18	348	866	756	981	261	187	187	52	305	
BN 200 L												878	768	993	64						

Примечание:

- (1) – размер дан для заднего конца вала
- (2) – для тормоза FD 07 размер R=226

В электродвигателях исполнения PS шестигранник ES не предусмотрен

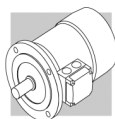

BN_FA

IM B14

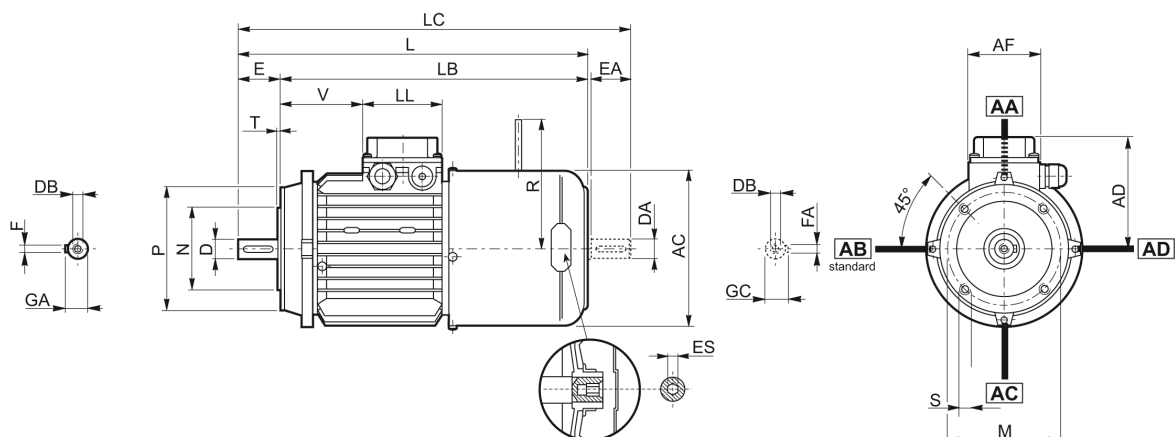

	Вал					Фланец					Мотор									
	D DA	E EA	DB	GA GC	F FA	M	N	P	S	T	AC	L	LB	LC	AD	AF	LL	V	R	ES
BN 63	11	23	M4	12.5	4	75	60	90	M5	2.5	121	272	249	119	95	74	80	26	116	5
BN 71	14	30	M5	16	5	85	70	105	M6		138	310	280	342	108		80	68	124	
BN 80	19	40	M6	21.5	6	100	80	120	M8	3	156	346	306	388	119	98	80	83	134	6
BN 90	24	50	M8	27	8	115	95	140		3.5	176	409	359	461	133		98	95	160	
BN 100	28	60	M10	31		10	130	110	160	M10	4	195	458	398	521	142	118	98	119	198
BN 112					219		484	424	547		157	98	128							
BN 132	38	80	M12	41	10	165	130	200	M10	4	258	603	523	686	193	118	118	180	200 (2)	

Примечание:

(1) – для тормоза FD 07 размер R=226

Размеры соединительной коробки AD, AF, LL, V двигателей BN_FA идентичны соответствующим размерам двигателей BN_FD.

В электродвигателях исполнения PS шестигранник ES не предусмотрен

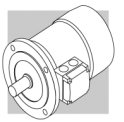

BN_FA

IM B5

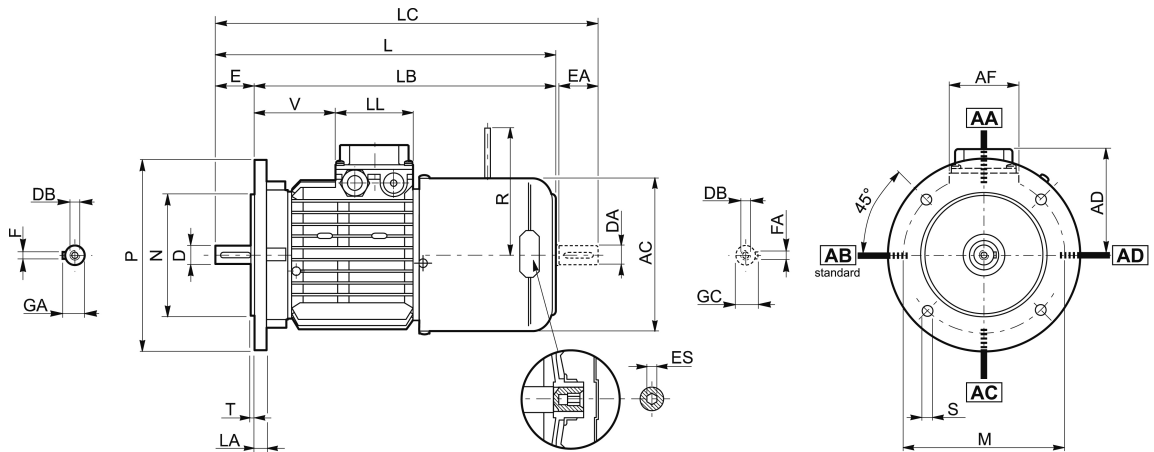

	Вал					Фланец						Мотор																			
	D DA	E EA	DB	GA GC	F FA	M	N	P	S	T	LA	AC	L	LB	LC	AD	AF	LL	V	R	ES										
BN 63	11	23	M4	12.5	4	115	95	140	9.5	3	10	121	272	249	297	95	74	80	26	116	5										
BN 71	14	30	M5	16	5	130	110	160				138	310	280	342	108			68	124											
BN 80	19	40	M6	21.5	6	165	130	200	11.5	3.5	11.5	156	346	306	388	119	98	98	83	134	6										
BN 90	24	50	M8	27	8							176	409	359	461	133			95	160											
BN 100	28	60	M10	31	8	215	180	250	14	4	14	195	458	398	521	142	118	118	119	198	6										
BN 112											15	219	484	424	547	157			128												
BN 132	38	80	M12	41	10	265	230	300			16	258	603	523	686	193	118	118	180	200 (2)											
BN 160 MR	42 38 (1)	110 80 (1)	M16 M12 (1)	45 41 (1)	12 10 (1)	300	250	350	18.5	5	15	672	562	755	193	118	118	218	217												
BN 160 M												736	626	820	245	187	187	51	247	—											
BN 160 L																															
BN 180 M												48 38 (1)			51.5 41 (1)	14 10 (1)							780	670	864						

Примечание:

- (1) – размер дан для заднего конца вала
- (2) – для тормоза FD 07 размер R=226

Размеры соединительной коробки AD, AF, LL, V двигателей BN_FA идентичны соответствующим размерам двигателей BN_FD.

В электродвигателях исполнения PS шестигранник ES не предусмотрен

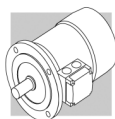

BN_BA

IM B14

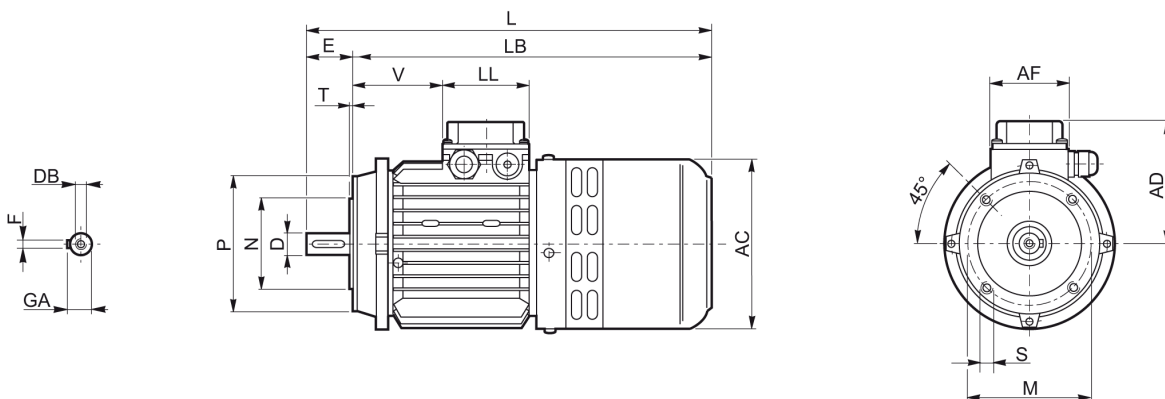

	Вал					Фланец					Мотор						
	D	E	DB	GA	F	M	N	P	S	T	AC	L	LB	AD	AF	LL	V
BN 63	11	23	M4	12.5	4	75	60	90	M5	2.5	124	298	275	95	74	80	28
BN 71	14	30	M5	16	5	85	70	105	M6		138	327	297	108			68
BN 80	19	40	M6	21.5	6	100	80	120	M8	3	156	372	332	119	98	98	83
BN 90	24	50	M8	27	8	115	95	140		M8	3.5	176	425	375			133
BN 100	28	60	M10	31		8	130	110	160	M8	3.5	195	477	417	142	98	98
BN 112					219							500	440	157	128		
BN 132	38	80	M12	41	10	165	130	200	M10	4	258	638	558	193	118	118	180

Примечание:

Размеры соединительной коробки AD, AF, LL, V двигателей BN_BA идентичны соответствующим размерам двигателей BN_FD.

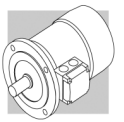

BN_BA

IM B5

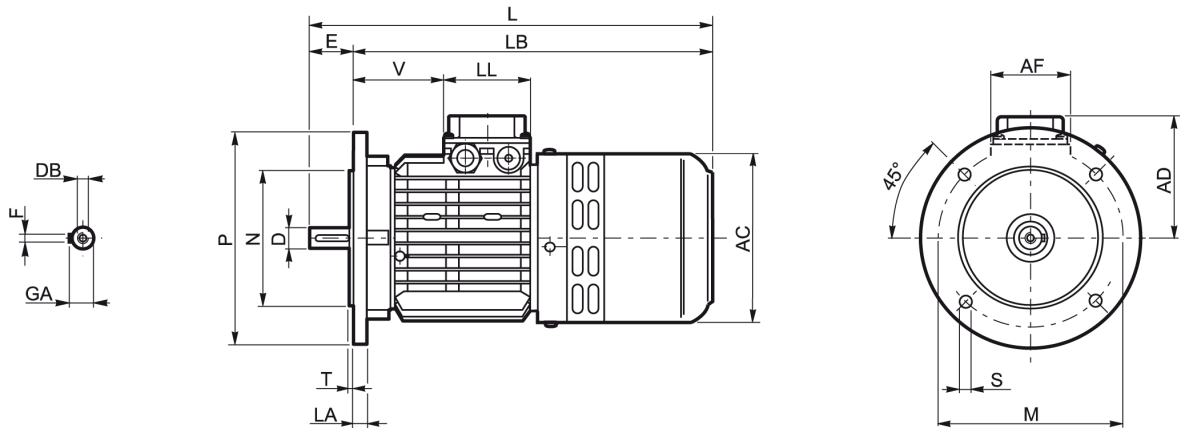

	Вал					Фланец						Мотор							
	D	E	DB	GA	F	M	N	P	S	T	LA	AC	L	LB	AD	AF	LL	V	
BN 63	11	23	M4	12.5	4	115	95	140	9.5	3	10	124	298	275	95	74	80	28	
BN 71	14	30	M5	16	5	130	110	160		9.5		10	138	327	297			108	68
BN 80	19	40	M6	21.5	6	165	130	200	11.5	3.5	11.5	156	372	332	119	98	98	83	
BN 90	24	50	M8	27	8	165						130	200	11.5	3.5			11.5	176
BN 100	28	60	M10	31	8	215	180	250	14	4	14	195	477	417	142	98	98	119	
BN 112												15	219	500	440			157	128
BN 132	38	80	M12	41	10	265	230	300	14	4	16	258	638	558	193	118	118	180	

Примечание:

Размеры соединительной коробки AD, AF, LL, V двигателей BN_BA идентичны соответствующим размерам двигателей BN_FD.

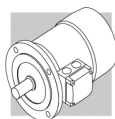

M

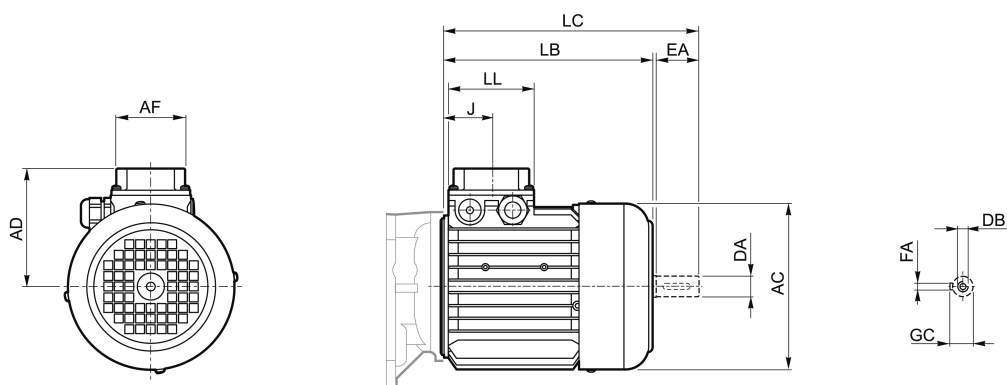

	Доп. вал с неприводимой стороны					Мотор						
	DA	EA	DB	FA	GC	AC	LB	LC	AF	LL	J	AD
M 0	9	20	M3	3	10.2	110	133	155	74	80	42	91
M 05	11	23	M4	4	12.5	121	165	191			48	95
M 1 S	14	30	M5	5	16	138	163	195			45	108
M 1 L							187	219	44	119		
M 2 S	19	40	M6	6	21.5	15	202	245	98	98	53.5	142
M 3 S	28	60	M10	8	31	195	230	293				
M 3 L							262	325				
M 4	38	80	M12	10	41	258	361	444	118	118	64.5	193
M 4 LC							396	479				
M 5 S						310	418	502	187	187	77	245
M 5 L							462	546				

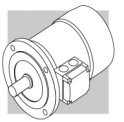

M_FD

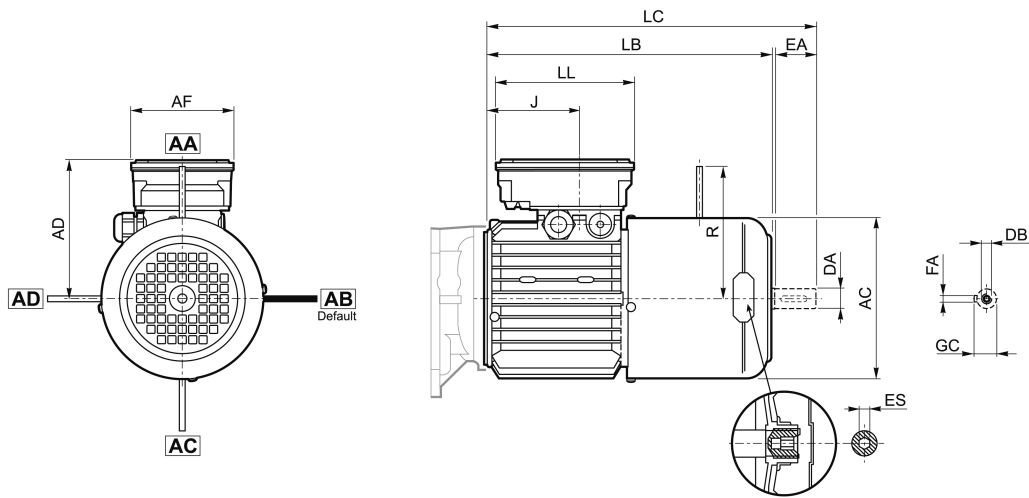

	Доп. вал с неприводимой стороны					Мотор									
	DA	EA	DB	FA	GC	AC	LB	LC	AF	LL	J	AD	R	ES	
M 05	11	23	M4	4	12.5	121	231	256	98	133	48	119	96	5	
M 1 S	14	30	M5	5	16	138	226	258			73	132	103		
M 1 L							248	280			88	143	129		
M 2 S	19	40	M6	6	21.5	156	272	314	110	165	124.5	155	160	6	
M 3 S	28	60	M10	8	31	195	326	389			185.5	210	204 (1)		
M 3 L							353	416			64.5		226		
M 4	38	80	M12	10	41	258	470	553	140	188	77	245	266	—	
M 4 LC							495	278							210
M 5 S						310	602	686	187	187	77	245	266		
M 5 L															

Примечание:

(1) – для тормоза FD 07 размер R=226

шестигранник "ES" отсутствует в опции PS

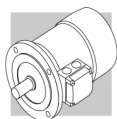

M_FA

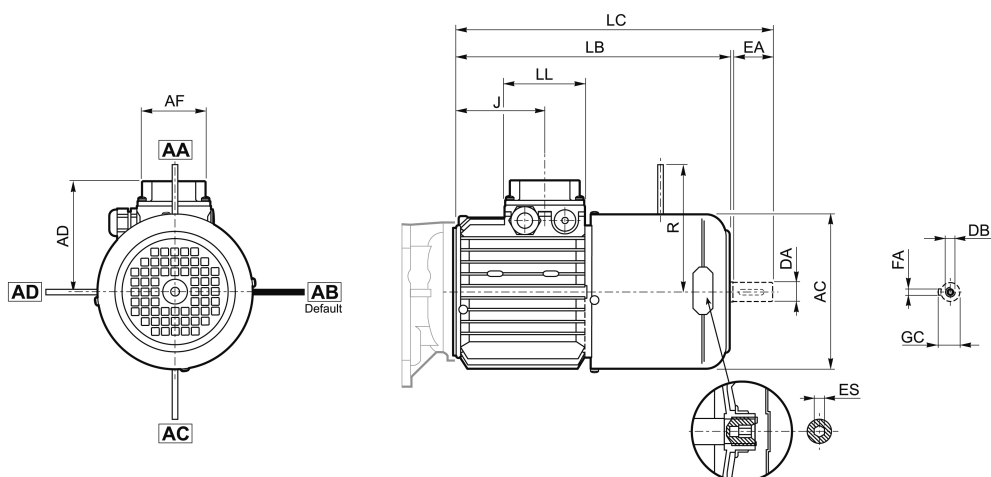

	Доп. вал с неприводимой стороны					Мотор									
	DA	EA	DB	FA	GC	AC	LB	LC	AF	LL	J	AD	R	ES	
M 05	11	23	M4	4	12.5	121	231	256	74	80	48	95	116	5	
M 1 S	14	30	M5	5	16	138	226	258			73	108	124		
M 1 L							248	280			88	119	134		
M 2 S	19	40	M6	6	21.5	156	272	314			98	98	124.5		142
M 3 S	28	60	M10	8	31	195	326	389	118	118	185.5	193	200 (1)	6	
M 3 L							353	416							64.5
M 4	38	80	M14	10	41	258	470	553	187	187	77	245	247		
M 4 LC							495	278							
M 5 S			M12			310	558	642							
M 5 L	602	686													

Примечание:

(1) – для тормоза FD 07 размер R=226

шестигранник "ES" отсутствует в опции PS

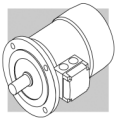
**BONFIGLIOLI RIDUTTORI S.p.A.**

Via Giovanni XXIII, 7/a
40012 Lippo di Calderara di Reno
Bologna (Italy)

Tel. +39 051 6473111
Fax +39 051 6473126
bonfiglioli@bonfiglioli.com
www.bonfiglioli.com

Company Certified UNI EN ISO 9001:2000



Bologna, 20/06/2008

DICHIARAZIONE DI CONFORMITÀ RoHS
DECLARATION OF CONFORMITY RoHS
KONFORMITÄTSERKLÄRUNG RoHS
DECLARATION DE CONFORMITE RoHS

Si dichiara che i prodotti elencati in questo catalogo sono costruiti secondo i requisiti della Direttiva 2002/95 CE con particolare riferimento alla limitazione delle seguenti sostanze pericolose:

We hereby declare that products listed in this catalogue are manufactured as per the requirements of Directive 2002/95 EC with reference to the restriction of the following hazardous substances:

Hiermit erklären wir, dass die Produkte, die in diesem Katalog aufgeführt werden, in Übereinstimmung mit den Anforderung der Richtlinie 2002/95/EG gefertigt werden bezogen auf die Restriktion der folgenden gefährlichen Substanzen:

Nous certifions que les produits présentés dans ce catalogue sont fabriqués selon les conditions indiquées dans la Directive 2002/95 CE en référence à la limitation des substances dangereuses indiquées ci-dessous :

Piombo	<i>Lead</i>	Blei	<i>Plomb</i>	[Pb]
Mercurio	<i>Mercury</i>	Quecksilber	<i>Mercur</i>	[Hg]
Cadmio	<i>Cadmium</i>	Cadmium	<i>Cadmium</i>	[Cd]
Cromo esavalente	<i>Hexavalent Chromium</i>	sechswertiges Chrom	<i>Chrome hexavalent</i>	[Cr (VI)]
Bifenile polibromurati	<i>Polybrominated biphenyls</i>	polybromiertes Biphenyl	<i>Diphényle polybromé</i>	[PBB]
Eteri di difenili	<i>Polybrominated</i>	polybromierte	<i>Ether diphénylique</i>	
polibromurati	<i>Diphenyl Ethers</i>	Diphenylether	<i>polybromé</i>	[PBDE]

Direzione Ricerca e Sviluppo

Gestione Sistema Qualità

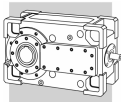

УКАЗАТЕЛЬ ИЗМЕНЕНИЙ И ДОПОЛНЕНИЙ(R)

R0

ОПИСАНИЕ

Настоящая редакция каталога отменяет и заменяет все его предыдущие издания и редакции. Компания BONFIGLIOLI оставляет за собой право вносить изменения в конструкцию изделий без предварительного уведомления. Полное и частичное воспроизведение каталога без письменного разрешения запрещено.

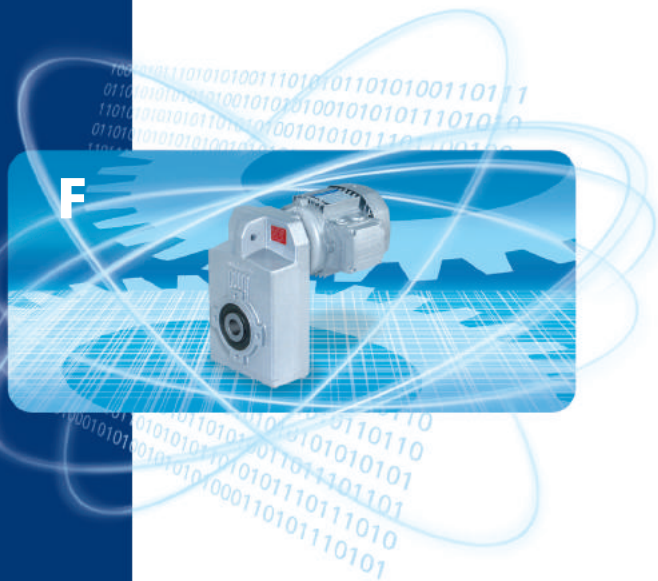

www.bonfiglioli.com

 **BONFIGLIOLI**

Компания Редуктор

Г. Нижний Новгород, ул. Зайцева 31, оф. 508

Тел./факс +7 (831) 223-81-81

E-mail: info@reduktor.nnov.ru

Сайт: www.reduktor-bonfiglioli.ru